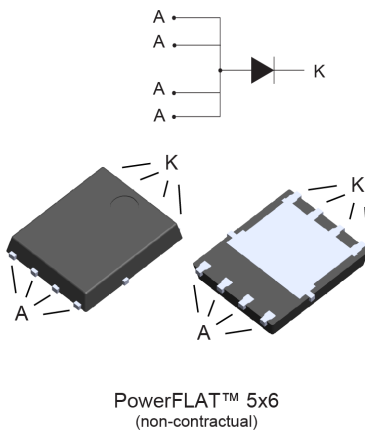


## 100 V, 30 A power Schottky rectifier



### Features

- Very low conduction losses
- Low forward voltage drop
- Low thermal resistance
- High specified avalanche capability
- High integration
- ECOPACK®2 compliant

### Applications

- Switching diode
- SMPS
- DC/DC converter
- LED lighting
- Desktop power supply

### Description

The **STPS30M100DJF** is a power Schottky rectifier optimized for switch mode power supply and high frequency DC to DC converters.

Packaged in PowerFLAT™, this device is intended to be used in adaptors requiring good efficiency at both low and high load. Its low profile was especially designed to be used in applications with space-saving constraints.

PowerFLAT™ is a trademark of STMicroelectronics.

#### Product status link

[STPS30M100DJF](#)

#### Product summary

Symbol	Value
$I_{F(AV)}$	30 A
$V_{RRM}$	100 V
$T_j$ (max.)	150 °C
$V_F$ (typ.)	0.66 V

# 1 Characteristics

**Table 1. Absolute Ratings (limiting values at 25 °C, unless otherwise specified, anode terminals short circuited)**

Symbol	Parameter	Value	Unit	
V <sub>RRM</sub>	Repetitive peak reverse voltage	100	V	
I <sub>F(RMS)</sub>	Forward rms current	45	A	
I <sub>F(AV)</sub>	Average forward current, $\delta = 0.5$ , square wave	T <sub>C</sub> = 90 °C	30	A
I <sub>FSM</sub>	Surge non repetitive forward current	t <sub>p</sub> = 10 ms sinusoidal	200	A
P <sub>ARM</sub>	Repetitive peak avalanche power	t <sub>p</sub> = 10 $\mu$ s , T <sub>j</sub> = 125 °C	1080	W
T <sub>stg</sub>	Storage temperature range	-65 to +175	°C	
T <sub>j</sub>	Maximum operating junction temperature <sup>(1)</sup>	150	°C	

1.  $(dP_{tot}/dT_j) < (1/R_{th(j-a)})$  condition to avoid thermal runaway for a diode on its own heatsink.

**Table 2. Thermal resistance parameters**

Symbol	Parameter	Max. value	Unit
R <sub>th(j-c)</sub>	Junction to case	2.5	°C/W

For more information, please refer to the following application note :

- AN5046 : Printed circuit board assembly recommendations for STMicroelectronics PowerFLAT™ packages

**Table 3. Static electrical characteristics (anode terminals short circuited)**

Symbol	Parameter	Test conditions	Min.	Typ.	Max.	Unit	
I <sub>R</sub> <sup>(1)</sup>	Reverse leakage current	T <sub>j</sub> = 25 °C	V <sub>R</sub> = V <sub>RRM</sub>	-		100	$\mu$ A
		T <sub>j</sub> = 125 °C		-	10	40	mA
V <sub>F</sub> <sup>(1)</sup>	Forward voltage drop	T <sub>j</sub> = 25 °C	I <sub>F</sub> = 15 A	-		0.82	V
		T <sub>j</sub> = 125 °C		-	0.58	0.66	
		T <sub>j</sub> = 25 °C	I <sub>F</sub> = 30 A			0.96	
		T <sub>j</sub> = 125 °C			0.66	0.73	

1. Pulse test: t<sub>p</sub> = 380  $\mu$ s,  $\delta < 2\%$

To evaluate the conduction losses, use the following equation:

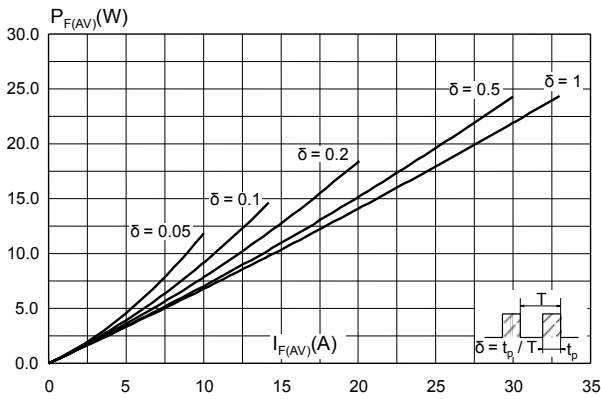
$$P = 0.65 \times I_{F(AV)} + 0.00267 \times I_{F(RMS)}^2$$

For more information, please refer to the following application notes related to the power losses :

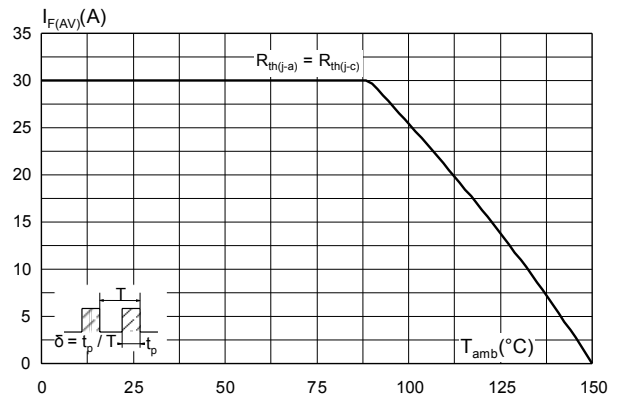
- AN604: Calculation of conduction losses in a power rectifier
- AN4021: Calculation of reverse losses on a power diode

### 1.1 Characteristics (curves)

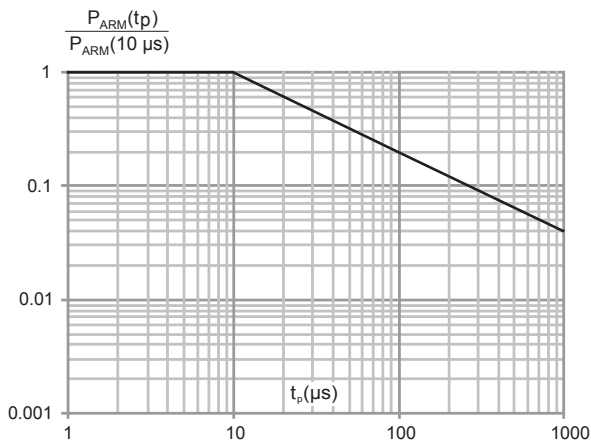
**Figure 1. Average forward power dissipation versus average forward current**



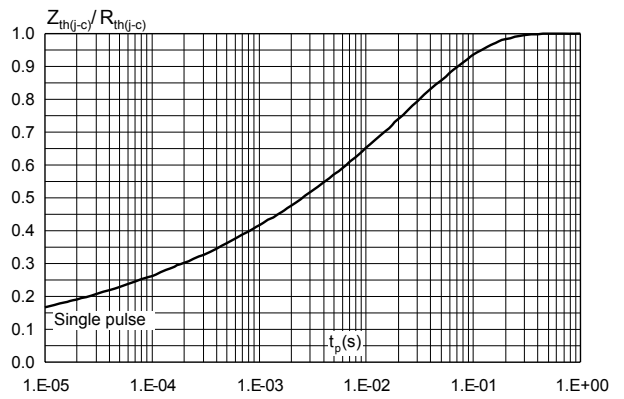
**Figure 2. Average forward current versus ambient temperature ( $\delta = 0.5$ )**

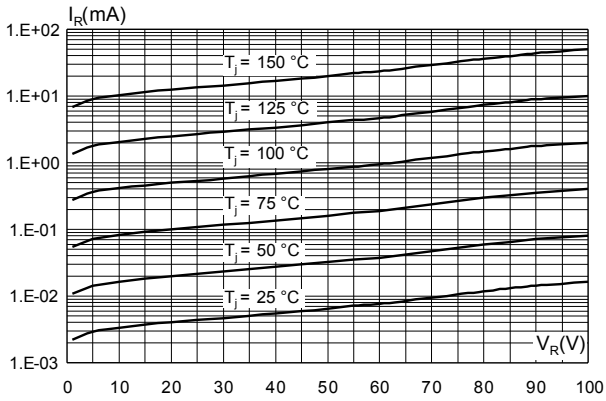
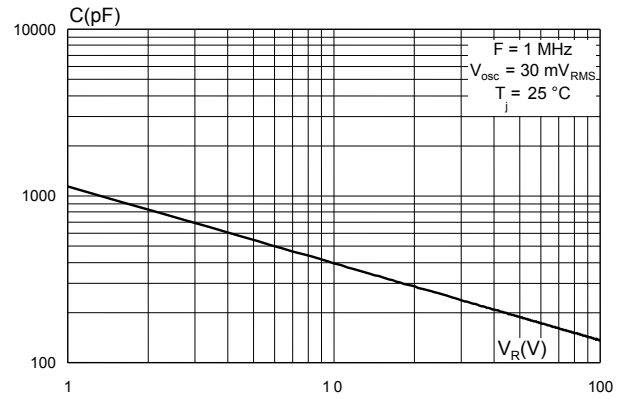
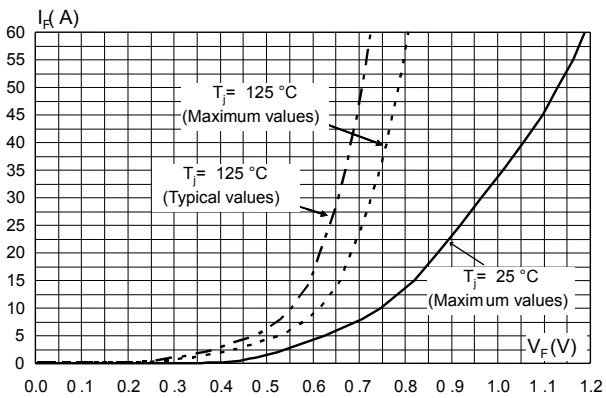
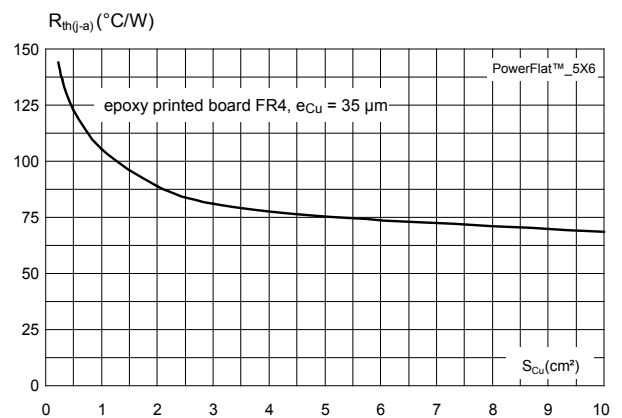


**Figure 3. Normalized avalanche power derating versus pulse duration ( $T_j = 125^{\circ}C$ )**



**Figure 4. Relative variation of thermal impedance junction to case versus pulse duration**



**Figure 5. Reverse leakage current versus reverse voltage applied (typical values)**

**Figure 6. Junction capacitance versus reverse voltage applied (typical values)**

**Figure 7. Forward voltage drop versus forward current**

**Figure 8. Thermal resistance junction to ambient versus copper surface under tab**


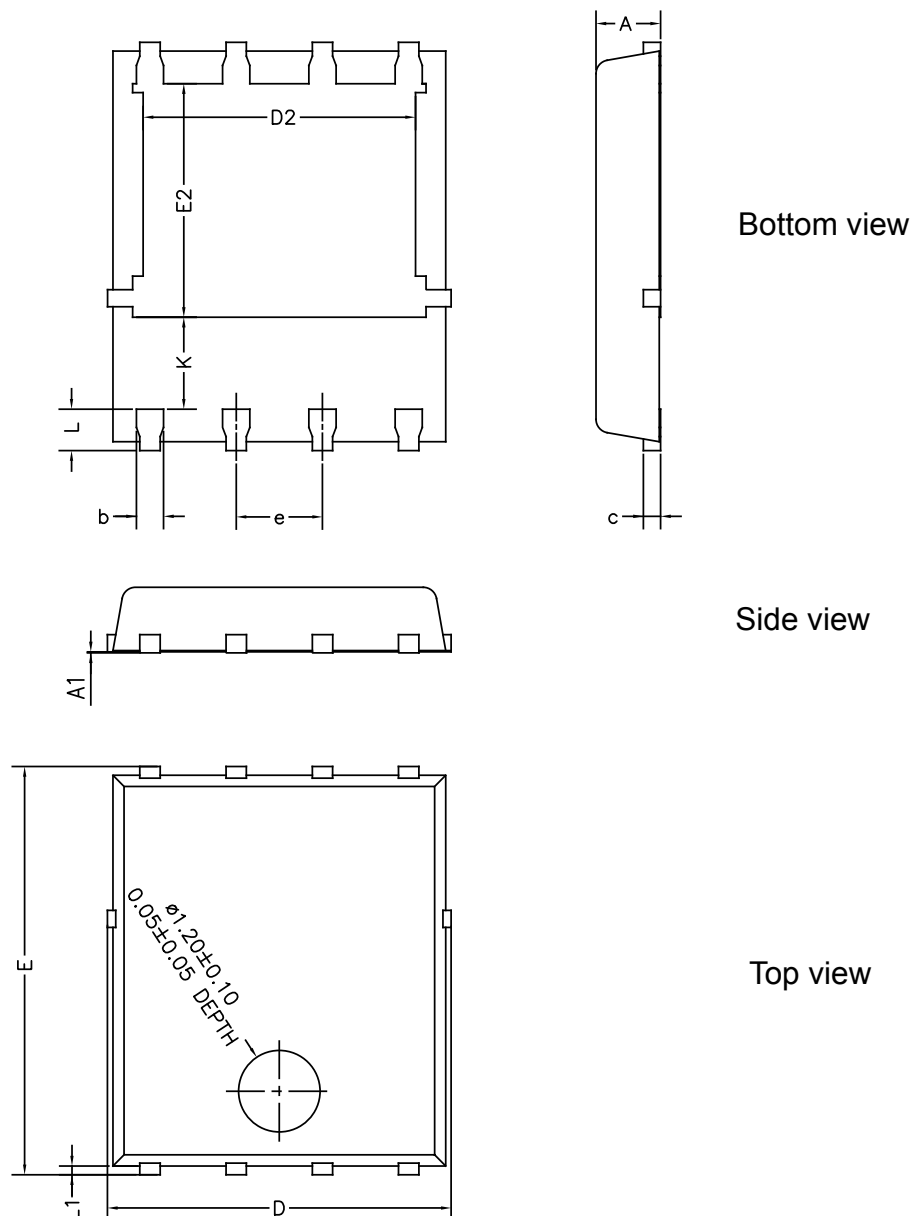
## 2 Package information

In order to meet environmental requirements, ST offers these devices in different grades of **ECOPACK®** packages, depending on their level of environmental compliance. ECOPACK® specifications, grade definitions and product status are available at: [www.st.com](http://www.st.com). ECOPACK® is an ST trademark.

### 2.1 PowerFLAT™ 5x6 package information

- Epoxy meets UL 94,V0
- Cooling method: by conduction (C)

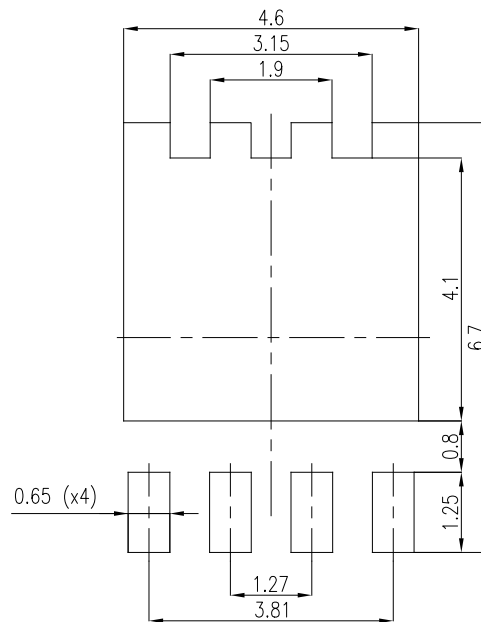
**Figure 9. PowerFLAT™ 5x6 package outline (non-contractual)**



**Table 4. PowerFLAT™ 5x6 mechanical data**

Ref	Dimensions					
	Millimeters			Inches (for reference only)		
	Min.	Typ.	Max.	Min.	Typ.	Max.
A	0.80		1.00	0.031		0.039
A1	0.00		0.05	0.000		0.002
b	0.30		0.50	0.01		0.02
c		0.25			0.010	
D	4.80		5.40	0.189		0.212
D2	3.91		4.45	0.154		0.175
e		1.27			0.050	
E	5.90		6.35	0.232		0.250
E2	3.34		3.70	0.138		0.146
L	0.50		0.80	0.020		0.031
K	1.10		1.575	0.015		0.023
L1	0.05	0.15	0.25	0.002	0.006	0.009

**Figure 10. PowerFLAT™ 5x6 recommended footprint (dimensions are in mm)**



### 3 Ordering information

**Table 5. Ordering information**

Order code	Marking	Package	Weight	Base qty.	Delivery mode
STPS30M100DJF-TR	PS30M 100	PowerFLAT 5x6	0.095 g	3000	Tape and reel

## Revision history

**Table 6. Document revision history**

Date	Version	Changes
06-Nov-2009	1	First issue.
30-Jul-2010	2	Replace Power QFN with PowerFLAT.
15-Jan-2011	3	Add reference E in Table 5.
20-May-2011	4	Update all package illustrations. Updated base quantity and marking in Table 6. Updated terminal identification in captions of Table 2 and Table 4. Added Figure 14.
11-Jun-2018	5	Removed figure 5, figure 6 and figure 12. Updated Table 1. Absolute Ratings (limiting values at 25 °C, unless otherwise specified, anode terminals short circuited). Minor text changes to improve readability.
08-Feb-2019	6	Updated Section Cover image, Figure 9. PowerFLAT™ 5x6 package outline (non-contractual) and Table 4. PowerFLAT™ 5x6 mechanical data.



**IMPORTANT NOTICE – PLEASE READ CAREFULLY**

STMicroelectronics NV and its subsidiaries (“ST”) reserve the right to make changes, corrections, enhancements, modifications, and improvements to ST products and/or to this document at any time without notice. Purchasers should obtain the latest relevant information on ST products before placing orders. ST products are sold pursuant to ST’s terms and conditions of sale in place at the time of order acknowledgement.

Purchasers are solely responsible for the choice, selection, and use of ST products and ST assumes no liability for application assistance or the design of Purchasers’ products.

No license, express or implied, to any intellectual property right is granted by ST herein.

Resale of ST products with provisions different from the information set forth herein shall void any warranty granted by ST for such product.

ST and the ST logo are trademarks of ST. All other product or service names are the property of their respective owners.

Information in this document supersedes and replaces information previously supplied in any prior versions of this document.

© 2019 STMicroelectronics – All rights reserved