

FEMALE PLUG M8 90° ANGLED

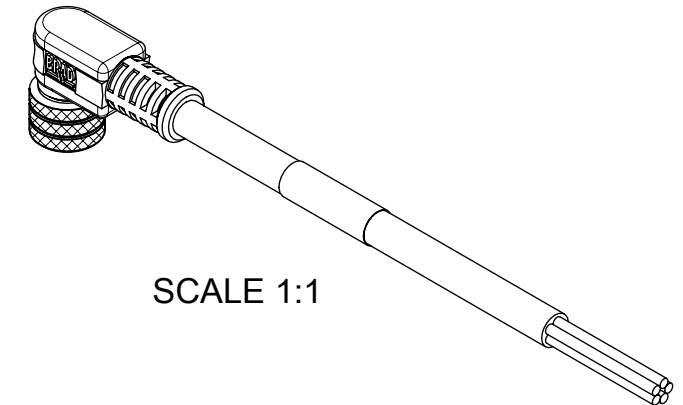

NOTES:
 RATED VOLTAGE: 3 contacts 60V AC/DC
 4 and 5 contacts 30V AC/DC
 CURRENT RATING: 3, 4, 5 contacts 3A
 PROTECTION CLASS: IP 67
 TEMPERATURE: -25°C / +80°C

CONTACT POSITION FRONT VIEW:

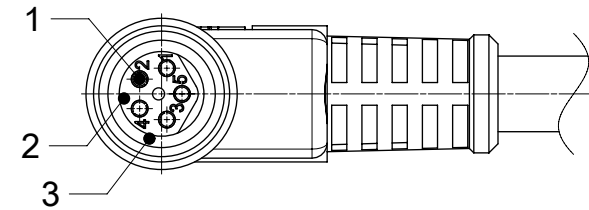
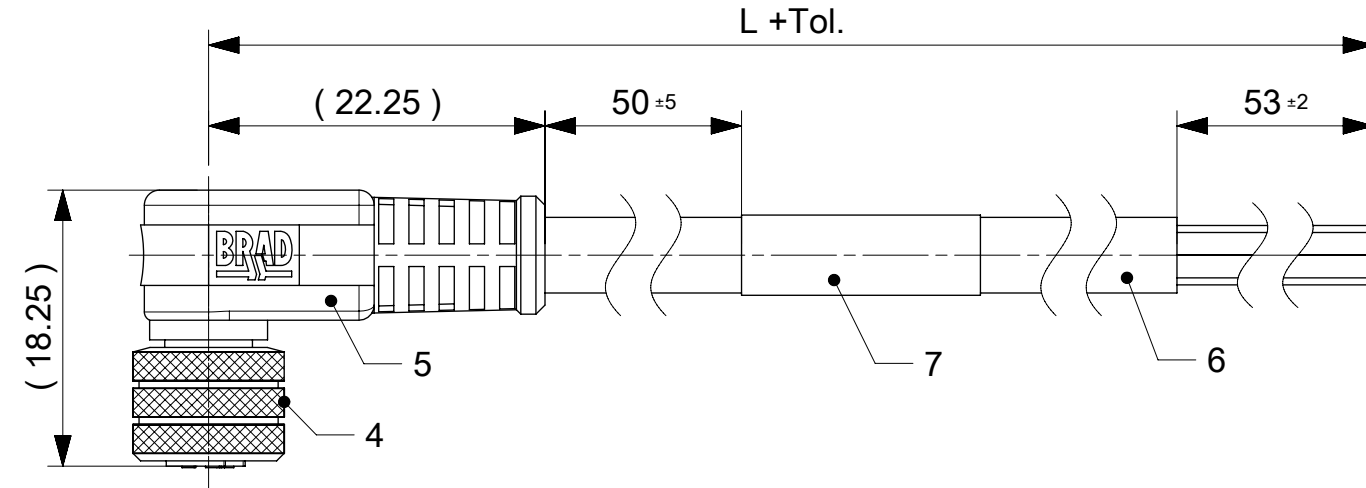
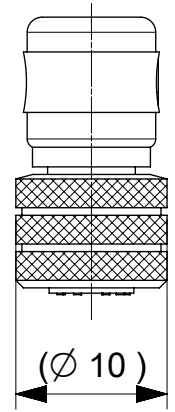
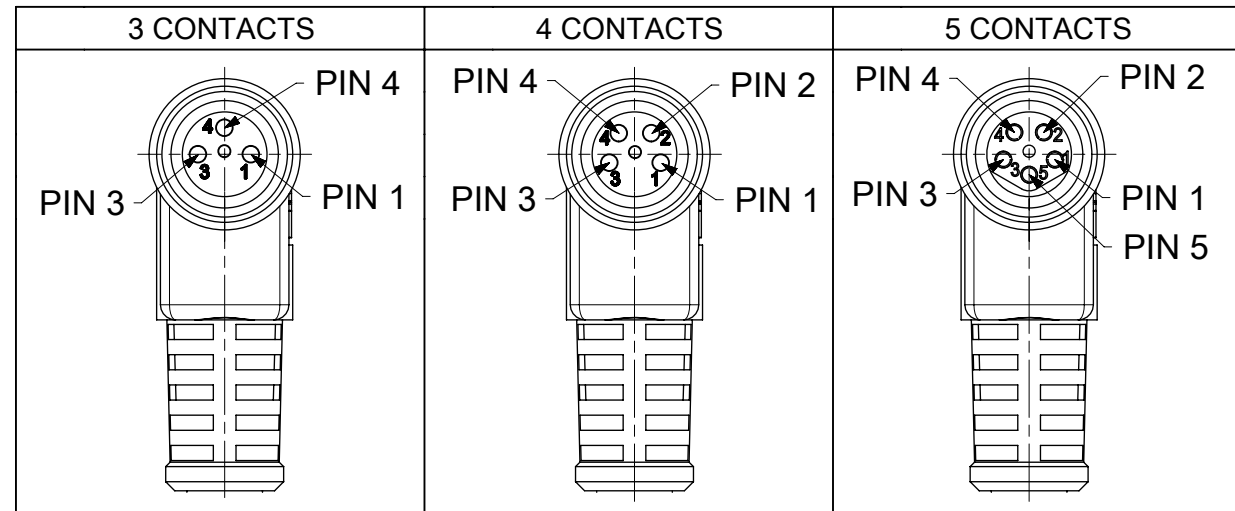

PIN	WIRE	PIN	WIRE	PIN	WIRE
1	BROWN	1	BROWN	1	BROWN
2	-	2	WHITE	2	WHITE
3	BLUE	3	BLUE	3	BLUE
4	BLACK	4	BLACK	4	BLACK
				5	GREY

CODING ACCORDING TO IEC 61076-2-104

FOR OPTIONS SEE - NUMERICAL CODE - ON SHEET 2

ITEM	QTY.	DESCRIPTION	MATERIAL	FINISH
7	1	LABEL	VINYL	-
	-	PRINTING FOR CABLES IXX	-	-
6	-	CABLE	SEE SHEET 2	-
5	-	OVERMOULDING BLACK	TPU	-
4	1	NUT M8 FEMALE	BRASS	NICKEL
3	1	O-RING RED	FKM	-
2	1	INSERT FEMALE BLACK	TPU	-
1	3 / 4 / 5	CONTACT M8 FEMALE	BRASS	SELECTIVE Au OVER Ni

THIS DRAWING CONTAINS INFORMATION THAT IS PROPRIETARY TO MOLEX ELECTRONIC TECHNOLOGIES, LLC AND SHOULD NOT BE USED WITHOUT WRITTEN PERMISSION

DIMENSION UNITS	SCALE	CURRENT REV DESC: REMOVED OBSOLETE PART NUMBERS AS PER PCN#510807.		molex	
mm	2:1				
GENERAL TOLERANCES (UNLESS SPECIFIED)		EC NO: 726454		CSE M8 XP AC BC RA XM SE	
ANGULAR TOL	± 1.0 °	DRWN: LIKITV 2022/10/26		PRODUCT CUSTOMER DRAWING	
4 PLACES	±	CHK'D: GGA 2022/11/30		DOCUMENT NUMBER	
3 PLACES	±	APPR: GGA 2022/11/30		1200868179	
2 PLACES	± 0.05	INITIAL REVISION:		DOC TYPE	
1 PLACE	± 0.3	DRWN: FGAIK 2016/11/02		PSD	
0 PLACES	± 0.5	APPR: RSILLER 2016/11/14		000	
DRAFT WHERE APPLICABLE MUST REMAIN WITHIN DIMENSIONS		THIRD ANGLE PROJECTION	DRAWING	SERIES	SHEET NUMBER
			A3-SIZE	120086	1 OF 3

ENGINEERING NO. - NUMERICAL CODE (Available parts see PART LIST table. Other parts available upon request).

OPTIONS

4 0 X 0 0 1 X X X M X X X X X

40=Nano-Change
M8x1
Single ended

Poles:
3=3 Contacts
4=4 Contacts
5=5 Contacts

Head style:
001=Plug Female Angled

Cable type: See Table

Units:
M=Meter

Length
Examples:
005=0.5 unit
010=1 unit
100=10 units

Overmold color:
Blank (Standard)=Black
G=Black / Y=Yellow
For cables K05, A10 = Yellow

Nut:
Blank (standard)=Knurled Brass Ni Plated
1=Stainless Steel
7=Teflon coat

H= 2 pcs. of I/D Carrier PVC Transparent
(Cables Ixx & P82 always with
2 pcs. of I/D Carrier)

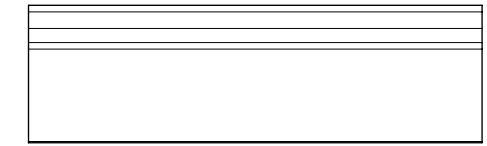
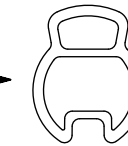

CABLE INFORMATION

CABLE TYPE	NO. OF WIRES	CROSS SECTION	CABLE JACKET	UL	CSA	TEMP. RATING	STATIC: TEMP. / BENDING RADIUS	DYNAMIC: TEMP. / BENDING RADIUS	DRAG CHAIN	SHIELD
A10	4	0.25mm ²	PVC YELLOW	UL 2661/1731	I/II A/B 105°C/300V	105°C	-	-	-	NO
E02	3 / 4 / 5	0.25mm ²	PVC BLACK	UL 2464/1729	C22.2 I/II A/B 80°C/300V	-	-30°C to +80°C, 10xO.D.	-10°C to +80°C, 15xO.D.	-	NO
H08	3 / 4 / 5	0.25mm ²	PUR BLACK LS0H	UL 21198/10493	C22.2 I/II A/B 80°C/300V	-	-40°C to +80°C, 5xO.D.	-25°C to +80°C, 10xO.D.	2 000 000 cycles, Temp max 60°C	NO
H09	4	0.34mm ²	PUR BLACK LS0H	UL 21198/10493	C22.2 I/II A/B 80°C/300V	-	-40°C to +80°C, 5xO.D.	-25°C to +80°C, 10xO.D.	2 000 000 cycles, Temp max 60°C	NO
I02	3 / 4	0.25mm ²	PVC (CEI) GREY	-	-	-	-30°C to +70°C	-5°C to +70°C	-	NO
K05	3	0.34mm ²	TPE YELLOW	UL ITC OR PLTC	I/II A/B 90°C/300V	105°C	-	-	-	NO
P02	3 / 4 / 5	0.25mm ²	PUR / PVC BLACK	-	-	-	-30°C to +80°C, 7xO.D.	-5°C to +80°C, 15xO.D.	-	NO
P82	3 / 4	0.34mm ²	PUR ORANGE	-	-	-50°C to +105°C	-	-	-	NO

CABLE LENGTH TOLERANCES

OVER [mm]	UP TO AND INCLUDING [mm]	TOLERANCES [mm]
0	305	+19
305	915	+45
915	1830	+56
1830	3660	+89
3660	7320	+165
7320	14640	+317
14640	30500	+610
30500	>	+2% of finished length

THIS DRAWING CONTAINS INFORMATION THAT IS PROPRIETARY TO MOLEX ELECTRONIC TECHNOLOGIES, LLC AND SHOULD NOT BE USED WITHOUT WRITTEN PERMISSION

DIMENSION UNITS	SCALE	CURRENT REV DESC: REMOVED OBSOLETE PART NUMBERS AS PER PCN#510807.		molex	
mm	1:1				
GENERAL TOLERANCES (UNLESS SPECIFIED)		EC NO: 726454		CSE M8 XP AC BC RA XM SE	
ANGULAR TOL	± 1.0 °	DRWN: LIKITV 2022/10/26		PRODUCT CUSTOMER DRAWING	
4 PLACES	±	CHK'D: GGA 2022/11/30		DOCUMENT NUMBER	
3 PLACES	±	APPR: GGA 2022/11/30		1200868179	
2 PLACES	± 0.05	INITIAL REVISION:		DOC TYPE	
1 PLACE	± 0.3	DRWN: FGAIK 2016/11/02		PSD	
0 PLACES	± 0.5	APPR: RSILLER 2016/11/14		DOC PART	
DRAFT WHERE APPLICABLE MUST REMAIN WITHIN DIMENSIONS		THIRD ANGLE PROJECTION		REVISION	
		DRAWING		A5	
		SERIES		SHEET NUMBER	
		A3-SIZE 120086		2 OF 3	
		MATERIAL NUMBER		CUSTOMER	
		GENERAL MARKET			

