

Revision Level			Revision Record	Changed	Date	Approved	Date
Drawing	State	Part					
01.2	Design Release		SEE ECN# 014403	FDS	4/20/18	EJH	4/20/18

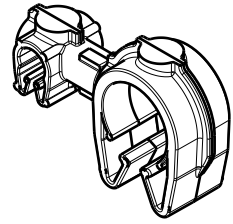

ISOMETRIC VIEW

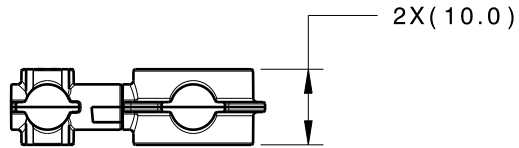
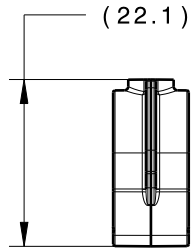
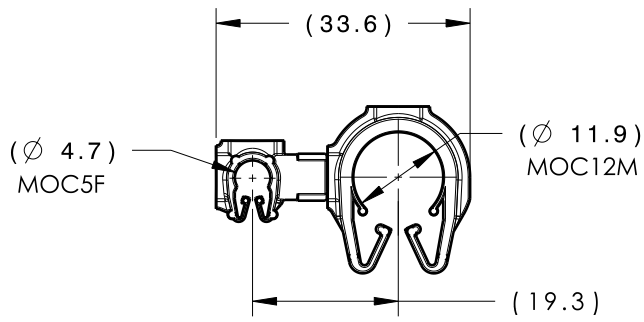

CLIPS ROTATE 360 DEGREES

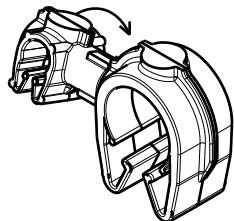

ISOMETRIC VIEW ROTATED

TYPE	MOC5F	MOC12M
HARNESS	4.5MM-5.3MM	11.5MM-13.0MM
HOSE	4.0MM-5.3MM	10.5MM-13.0MM
HARD PIPE/TUBE	4.8MM-5.5MM	12.0MM-13.8MM

*RECOMMENDED SIZES MAY DIFFER DEPENDING ON THE APPLICATION, PRODUCT REQUIREMENTS AND MATERIALS USED

**PATENT PENDING 29/582,271 

GLOBAL PART DESCRIPTION 	MOC5F			MOC12M**		
	DRAWING	MATERIAL	COLOR	DRAWING	MATERIAL	COLOR
MOC5FMOC12M-PA66HIRHSUV-BK	16-0313-000-CSU	PA66HIRHSUV	BLACK	16-0319-000-CSU	PA66HIRHSUV	BLACK

Material SEE CHART COLOR: SEE CHART	Units	millimeters	The copyright of this drawing is reserved by HellermannTyton. It is issued on condition that it is not reproduced, copied or disclosed to a third party, either wholly or in part, without the consent of HellermannTyton.	Drawn	TAT	2/20/17	Article/Type-No MOC5FMOC12M	Scale	1:1	
	Tolerance defined on each dimension	Approved		EJH	2/28/17	Title  5MM MOC COUPLED TO A 12MM MOC		Project Number	16-0326	
		HellermannTyton North America Email: corp@htamericas.com Web: www.hellermann.tyton.com			Drawing-No		PRODUCTION : Phase 	Format	AH	
					16-0326-136-CSU		Sheet	1/1		