

## DIN W48×H48mm Digital Backlight LCD Timer

### ■ Features

- Mounting space saving with compact design
  - : downsized by approx. 22% in depth compared to existing models (length of panel on the back side is 56mm)
- Available to set each value and time range separately when choosing Flicker (FK, FK I) or ON-OFF Delay (ON OFF D, ON OFF D I) output mode
- Adds Flicker 1 mode (LE4SA)
- Settable One-shot output time (0.01 to 99.99 sec) (existing model: fixed 0.5 sec)
- Configurable time range (added 9.999 sec)
  - : Settable by 0.001 sec unit
- Selectable Min. input time: 1ms or 20ms (LE4S)
- Improved return time: 100ms
- Backlight ON/OFF function
- Wide time range (0.01 sec to 9999 hour)
- Lock setting function for saving setting data
- Soft touch setting
- High visibility display with backlight



⚠ Please read "Safety Considerations" in the instruction manual before using.



### ■ Ordering Information

LE	4	S		
Item	Digit	Size	Output	
			No mark	Time-limit SPDT (1c)
			A	Time-limit DPDT (2c), Time-limit SPDT (1c)+Instantaneous SPDT (1c) (selectable)
			S	DIN W48×H48mm
			4	9999 (4-digit)
			LE	LCD Timer (touch type)

※8-pin socket (PG-08, PS-08(N)) is sold separately.

### ■ Specifications

Model	LE4S	LE4SA	
Function	Multi time and Multi operation		
Display method	LCD display (backlight)		
Power supply	24-240VAC ~ 50/60Hz, 24-240VDC= universal		
Allowable voltage range	90 to 110% of rated voltage		
Power consumption	Max. 4.5VA (24-240VAC ~ 50/60Hz), Max. 2W (24-240VDC=)	Max. 4VA (24-240VAC ~ 50/60Hz), Max. 1.6W (24-240VDC=)	
Return time	Max. 100ms		
Min. input signal width	START	—	
	INHIBIT		
	RESET		
Input	START	—	
	INHIBIT		
	RESET		
Timing operation	Signal ON Start	Power ON Start	
Control output	Contact type	Time limit SPDT (1c)	
	Contact capacity	250VAC ~ 5A, 30VDC= 5A resistive load	Selectable Time limit DPDT (2c), Time limit SPDT (1c)+ Instantaneous SPDT (1c) (depends on operation mode)
Relay life cycle	Mechanical	Min. 10,000,000 operations	
	Electrical	Min. 100,000 operations (at rated contact capacity)	
Output mode	10 operation modes	8 operation modes	
Environment	Ambient temp.	-10 to 55°C, storage: -25 to 65°C	
	Ambient humi.	35 to 85%RH	
Accessory	Bracket		

※Environment resistance is rated at no freezing or condensation.

SENSORS
CONTROLLERS
MOTION DEVICES
SOFTWARE
(J) Temperature Controllers
(K) SSRs
(L) Power Controllers
(M) Counters
(N) Timers
(O) Digital Panel Meters
(P) Indicators
(Q) Converters
(R) Digital Display Units
(S) Sensor Controllers
(T) Switching Mode Power Supplies
(U) Recorders
(V) HMIs
(W) Panel PC
(X) Field Network Devices

# LE4S Series

## Specifications

Model	LE4S	LE4SA
Repeat error		
SET error	Max. $\pm 0.01\% \pm 0.05$ sec (for Power ON Start) Max. $\pm 0.005\% \pm 0.03$ sec (for Signal ON Start)	Max. $\pm 0.01\% \pm 0.05$ sec
Voltage error		
Temperature error		
Insulation resistance	Over 100M $\Omega$ (at 500VDC megger)	
Dielectric strength	2,000VAC 50/60Hz for 1 min	
Noise immunity	$\pm 2$ kV the square wave noise (pulse width: 1 $\mu$ s) by the noise simulator	
Vibration	Mechanical	0.75mm amplitude at frequency of 10 to 55Hz (for 1 min) in each X, Y, Z direction for 1hour
	Malfunction	0.5mm amplitude at frequency of 10 to 55Hz (for 1 min) in each X, Y, Z direction for 10 min
Shock	Mechanical	300m/s <sup>2</sup> (approx. 30G) in each X, Y, Z direction for 3 times
	Malfunction	100m/s <sup>2</sup> (approx. 10G) in each X, Y, Z direction for 3 times
Approval	CE  us	
Unit weight	Approx. 98g	

## Dimensions

(unit: mm)

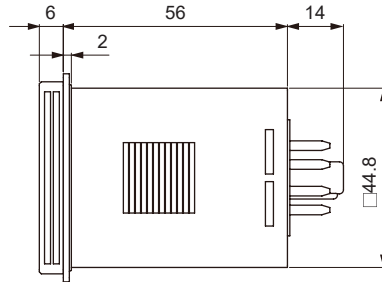
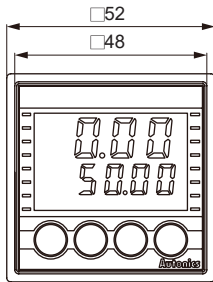

### Bracket

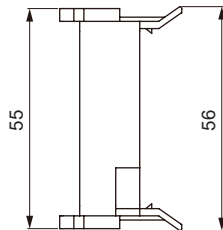
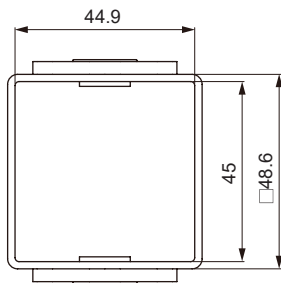
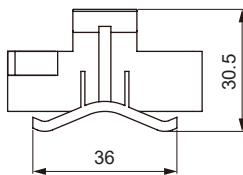

### Panel cut-out

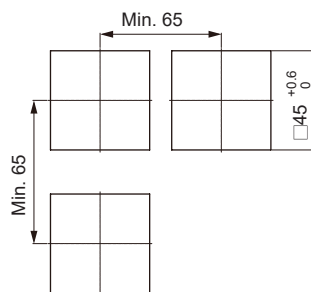

## ■ Connections

### ○ LE4S

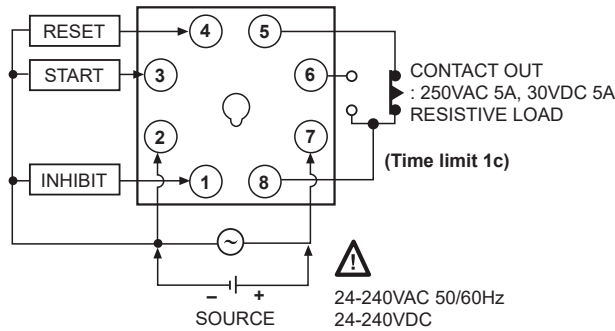

### ○ LE4SA

- [ON.D] [ON.D.II] [FK] [FKI] [INT] [T] [T.I] mode

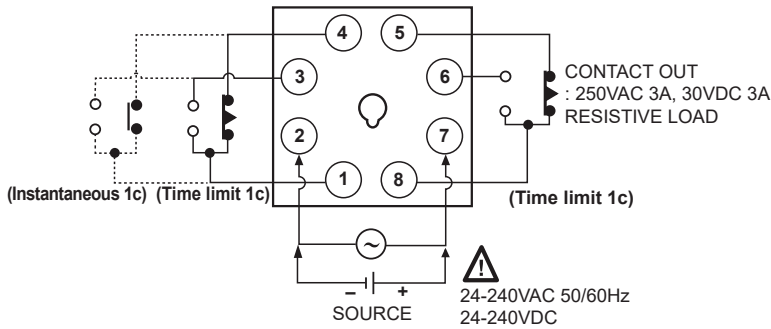

※Time limit 1c + Instantaneous 1c or Time limit 2c (selectable)  
 ([T] [T.I]: Time limit 2c only.)

- [ $\Delta$ - $\Delta$ ] mode

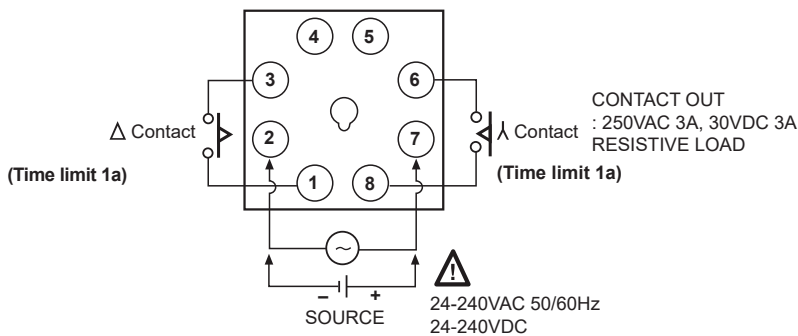

SENSORS
CONTROLLERS
MOTION DEVICES
SOFTWARE
(J) Temperature Controllers
(K) SSRs
(L) Power Controllers
(M) Counters
(N) Timers
(O) Digital Panel Meters
(P) Indicators
(Q) Converters
(R) Digital Display Units
(S) Sensor Controllers
(T) Switching Mode Power Supplies
(U) Recorders
(V) HMIs
(W) Panel PC
(X) Field Network Devices

# LE4S Series

## Input Connections

### Solid-state input

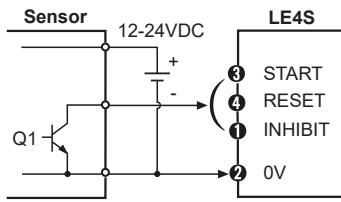

- Q1 is ON: Operating
- Sensor: NPN open collector output

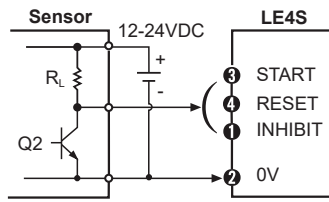

- Q2 is ON: Operating
- Sensor: NPN output

### Contact input

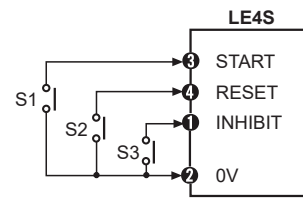

- S1, S2, S3 are ON: Operating
- Please use reliable contact enough to flow 5VDC 1mA.

※Be sure that it is not insulated between power and input terminal block.

## Unit Description

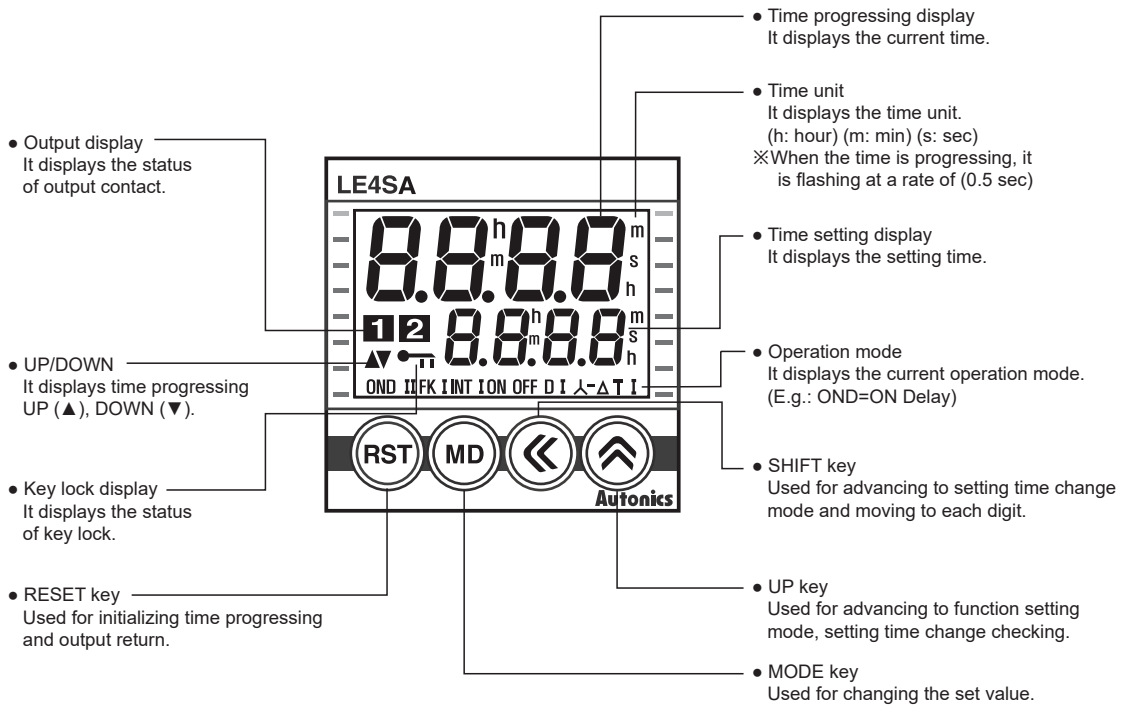

## ■ Function and Time Setting

### ◎ Configuration

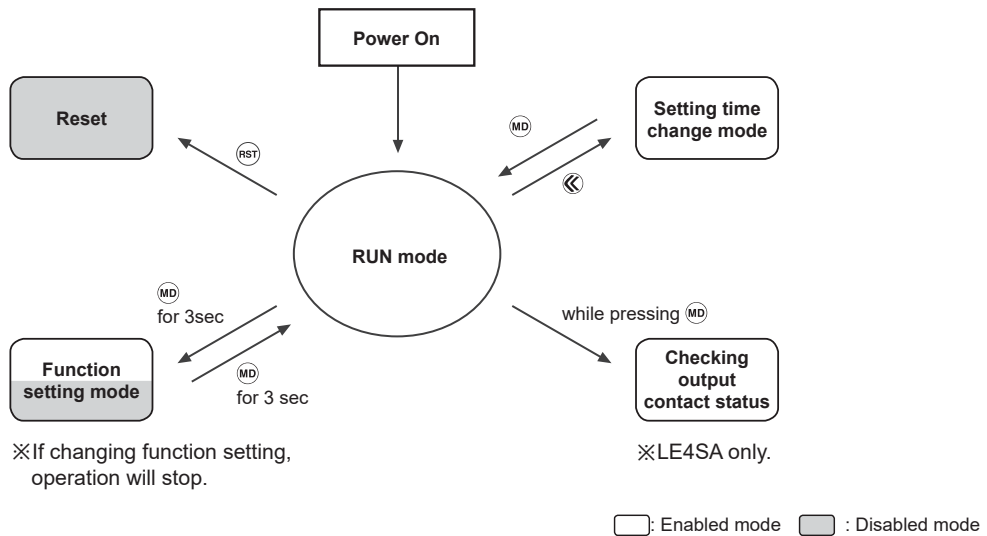

#### ● Reset

Reset using  $\text{RST}$  in Run mode

#### ● Run mode

The operation status (when power is on for the first time: factory default setting) is displayed. It could enter into function setting mode, setting value change mode and output contact status mode.

#### ● Function setting mode

If pressing  $\text{MD}$  over 3 sec in the Run mode, it will enter into function setting mode and if pressing  $\text{MD}$  over 3 sec in function setting mode, it will return to Run mode.

⊗ Even if it enters into function setting mode in Run mode, time progressing and output control will continue.

⊗ If operation settings are changed in function setting mode, all outputs will be off and reset on returning to run mode.

#### ● Output contact status mode (LE4SA only)

Output contact status are displayed while pressing  $\text{MD}$  in Run mode.

⊗ If pressing  $\text{MD}$  over 3 sec, it will enter into function setting mode.

#### ● Setting time change mode

Press  $\text{MD}$  to enter into setting time change mode and press  $\text{MD}$  to return to Run mode.

Even if signal is input when changing setting time, time progressing and output control will be continue.

If no key is pressed over 60 sec in setting time change mode, it will return to Run mode.

⊗ If no key is pressed over 60 sec in setting time change mode, it will return to Run mode and previous parameter value is not stored.

SENSORS

CONTROLLERS

MOTION DEVICES

SOFTWARE

(J) Temperature Controllers

(K) SSRs

(L) Power Controllers

(M) Counters

(N) Timers

(O) Digital Panel Meters

(P) Indicators

(Q) Converters

(R) Digital Display Units

(S) Sensor Controllers

(T) Switching Mode Power Supplies

(U) Recorders

(V) HMIs

(W) Panel PC

(X) Field Network Devices

# LE4S Series

## Function Setting Mode

### LE4S

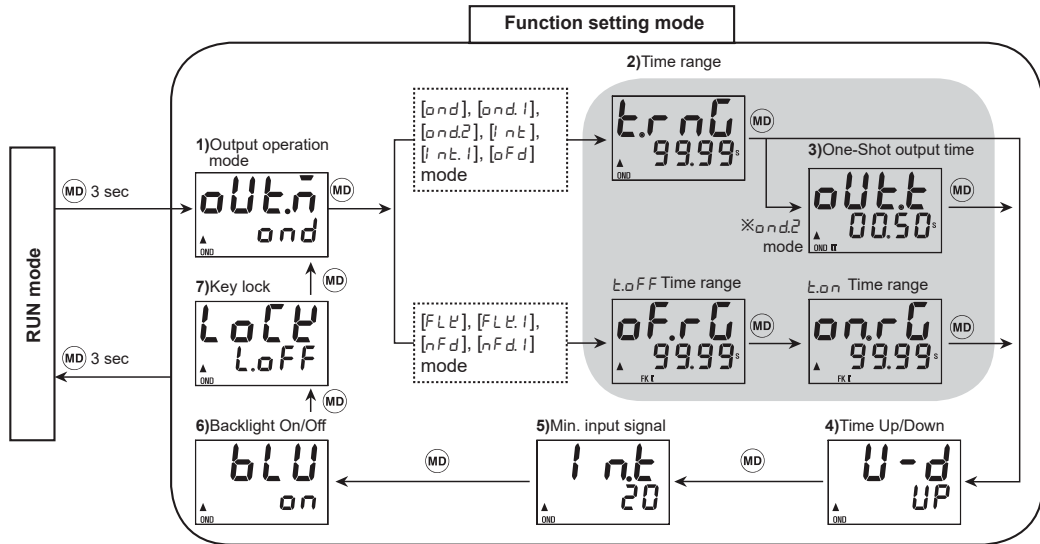

### LE4SA

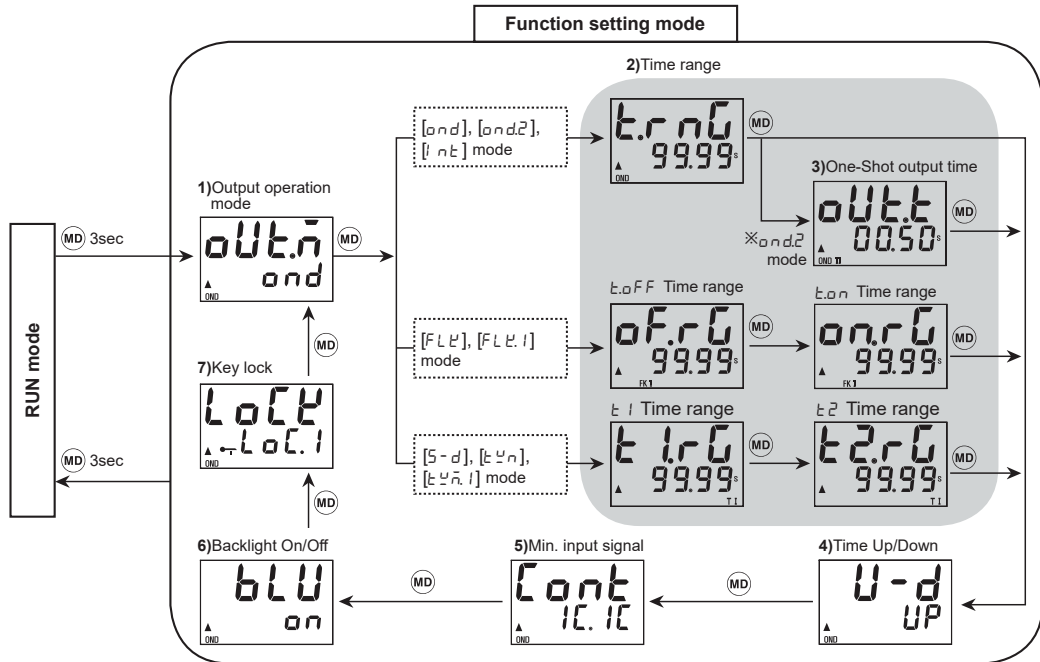

## Factory Default

### LE4S

Parameter		Factory default
Output operation mode	oUte.n	ond
Time range	t.rnG	99.99
Time Up/Down	U-d	UP
Min. input signal	I nt	20
Backlight On/Off	bLU	on
Key lock	LoCk	LoFF
Setting time	—	50.00

### LE4SA

Parameter		Factory default
Output operation mode	oUte.n	ond
Time range	t.rnG	99.99
Time Up/Down	U-d	UP
Output contact	Cont	1C.1C
Backlight On/Off	bLU	on
Key lock	LoCk	LoC.1
Setting time	—	50.00

## ■ Output Operation Mode

### ● LE4S/LE4SA output operation mode

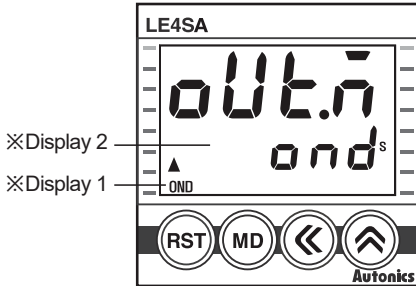

NO	※Display 1	※Display 2	Operation mode	LE4S	LE4SA
1	OND	ond	ON Delay	○	○
2	ONDI	ond.i	ON Delay 1	○	—
3	ONDII	ond.2	ON Delay 2	○	○
4	FK	FLY	Flicker	○	○
5	FKI	FLY.1	Flicker 1	○	○
6	INT	int	Interval	○	○
7	INTI	int.i	Interval 1	○	—
8	ON OFF D	nFd	ON-OFF Delay	○	—
9	ON OFF DI	nFd.i	ON-OFF Delay 1	○	—
10	OFF D	oFd	OFF Delay	○	—
11	λ-Δ	S-d	STAR-Delta	—	○
12	T	tyn	Twin	—	○
13	TI	tyn.i	Twin 1	—	○

### ● Output operation mode

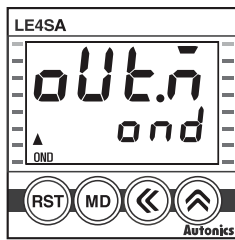

[Figure1]

- 1) In function setting mode, it enters into output operation mode as shown in the [Figure 1].
- 2) Select proper output operation mode using ◀ and ▶.  
(refer to Output operation flowchart)
- 3) Press MD to set output operation mode and move to next mode.
- 4) If pressing MD for 3 sec in any function setting mode, it will return to Run mode.

### ※Output operation flowchart < LE4S >

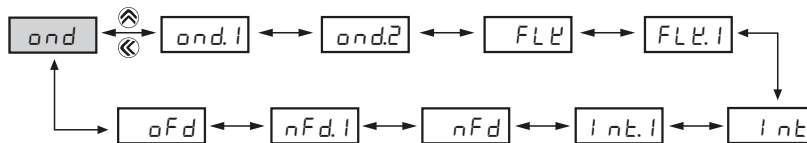

### < LE4SA >

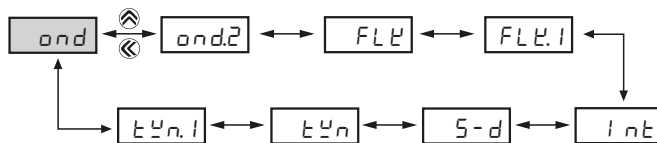

※The shaded parameter ( ) is factory default.

SENSORS

CONTROLLERS

MOTION DEVICES

SOFTWARE

(J) Temperature Controllers

(K) SSRs

(L) Power Controllers

(M) Counters

(N) Timers

(O) Digital Panel Meters

(P) Indicators

(Q) Converters

(R) Digital Display Units

(S) Sensor Controllers

(T) Switching Mode Power Supplies

(U) Recorders

(V) HMIs

(W) Panel PC

(X) Field Network Devices

# LE4S Series

## ■ Time Range

### • Time range specifications

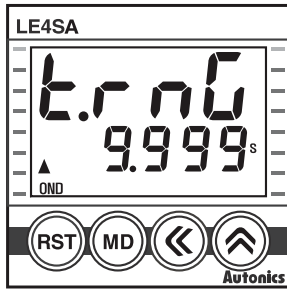

Parameter	Time range specification
9.999 s (9.999s)	0.001 sec to 9.999 sec
99.99 s (99.99s)	0.01 sec to 99.99 sec
999.9 s (999.9s)	0.1 sec to 999.9 sec
9999 s (9999s)	1 sec to 9999 sec
99m59 s (99m59s)	0 min 01 sec to 99 min 59 sec
999.9 m (999.9m)	0.1 min to 999.9 min
9999 m (9999m)	1 min to 9999 min
99h59m (99h59m)	0 hour 01 min to 99 hour 59 min
9999 h (99.99h)	0.01 hour to 99.99 hour
9999 h (999.9h)	0.1 hour to 999.9 hour
9999 h (9999h)	1 hour to 9999 hour

t.oFF time range

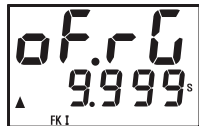

t.oN time range



t.1 time range

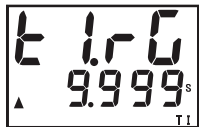

t.2 time range



### ※Time range according to output operation mode

- Time range[t.r nG]
  - : ond, ond.1, ond.2, i nt, i nt.1, oFd mode
- t.oFF/t.oN time range[oF.rG/oN.rG]
  - : FLt, FLt.1, nFd, nFd.1 mode
- t.1/t.2 time range[t.1.rG/t.2.rG]
  - : S-d, tYn, tYn.1 mode

### • Time range selection method

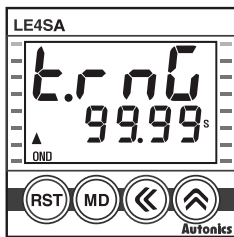

[Figure1]

When ond, ond.1, ond.2, i nt, i nt.1, oFd mode

- 1) In function setting mode, if it enters into time range mode, the characters will be displayed as shown in the [Figure 1].
- 2) Select the time range using ⏪ and ⏩.
- (refer to time range flowchart)
- 3) Press ⏹ to complete the time range setting and the next mode.
- 4) If pressing ⏹ for 3 sec, it will return to Run mode.

※When FLt, FLt.1, nFd, nFd.1, S-d, tYn, tYn.1 time range[t.1.rG, t.2.rG or oF.rG, oN.rG] can be individually set.

### ※Time range flowchart

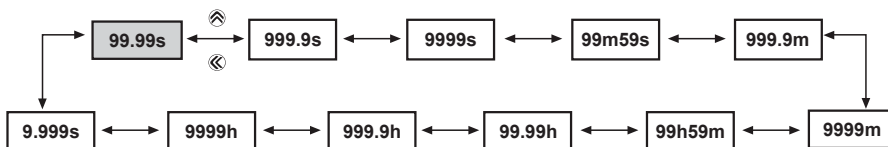

※The shaded parameter (□) is factory default.



## • One-shot output time setting

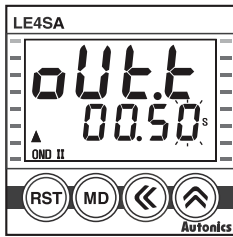

[Figure2]

※Factory default

When output operation mode ON Delay 2[ $o_n d.2$ ],

- 1) In function setting mode, if it enters into One-shot output time setting mode as shown in the [Figure 2], the last digit will flash.
- 2) Set One-shot output time using  $\leftarrow$  and  $\rightarrow$ . (setting range: 0.01s to 99.99s)
- 3) Pressing  $\text{MD}$  to complete one-shot output time setting and move to the next mode.
- 4) If pressing  $\text{MD}$  for 3 sec in any function setting mode, it will return to Run mode.

## • Time progress UP/DOWN setting

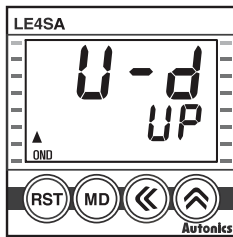

[Figure3]

※Factory default

- 1) In function setting mode, if it advances to UP/DOWN setting mode, the characters will be displayed as shown in the [Figure 3].
- 2) Select UP ( $\blacktriangle$ ), dn ( $\blacktriangledown$ ) using  $\leftarrow$ ,  $\rightarrow$ .



- 3) Press  $\text{MD}$  to complete UP/DOWN setting and move to the next mode.
- 4) If pressing  $\text{MD}$  for 3sec in any function setting mode, it will return to Run mode.

## • The minimum input signal setting (LE4S only)

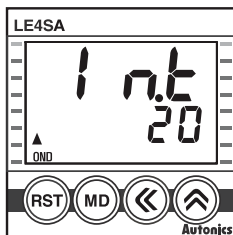

[Figure4]

※Factory default

RESET, START and INHIBIT.

- 1) In function setting mode, if it enters into input signal setting mode, the characters will be displayed as shown in the [Figure 4].
- 2) Select 1ms or 20ms using  $\leftarrow$ ,  $\rightarrow$ .



- 3) Press  $\text{MD}$  to complete input signal width and move to the next mode.
- 4) If Pressing  $\text{MD}$  over 3 sec in any function setting mode, it will return to Run mode.

## • Output contact setting (LE4SA only)

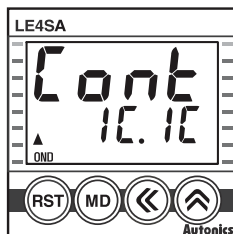

[Figure5]

※Factory default

- 1) In function setting mode, if it enters into output contact setting mode, the characters will be displayed as shown in the [Figure 5].

- 2) Select time limit 1c+instant limit 1c or time limit 2c using  $\leftarrow$ ,  $\rightarrow$ .  
(refer to LE4SA Series, Connections section for output contact connections)



- 3) Press  $\text{MD}$  to complete output contact setting and move to the next mode.
- 4) If pressing  $\text{MD}$  for 3 sec in any function setting, it will return to Run mode.  
※Except for Star-Delta, Twin and Twin 1 modes ( $2c$  is set automatically)  
※If pressing  $\text{MD}$  in Run mode, output contact setting value will be displayed.  
(if no key is pressed over 3 sec, it will enter into function setting mode.)

SENSORS
CONTROLLERS
MOTION DEVICES
SOFTWARE

(J) Temperature Controllers
(K) SSRs
(L) Power Controllers
(M) Counters
(N) Timers
(O) Digital Panel Meters
(P) Indicators
(Q) Converters
(R) Digital Display Units
(S) Sensor Controllers
(T) Switching Mode Power Supplies
(U) Recorders
(V) HMIs
(W) Panel PC
(X) Field Network Devices

# LE4S Series

## ● Backlight ON/OFF setting

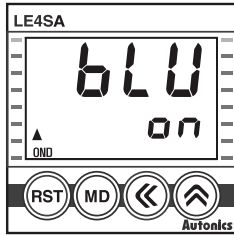

[Figure6]

※Factory default

1) In function setting mode, if it enters into Backlight ON/OFF setting mode, the characters will be displayed as shown in the [Figure 6].

2) Select Backlight *on* or *off* using  $\leftarrow$ ,  $\rightarrow$ .



3) Press  $\text{MD}$  to complete Backlight ON/OFF setting and move to the next mode.

4) If pressing  $\text{MD}$  for 3 sec in any function setting mode, it will return to Run mode.

## ● Key Lock setting

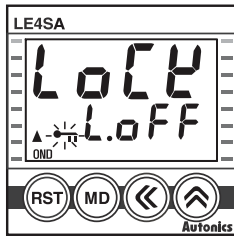

[Figure7]

※Factory default

1) In function setting mode, if it enters into Key Lock setting mode, the characters will be displayed as shown in the [Figure 7].

2) Select *LoFF*, *LoC.1*, *LoC.2* or *LoC.3* using  $\leftarrow$ ,  $\rightarrow$ .

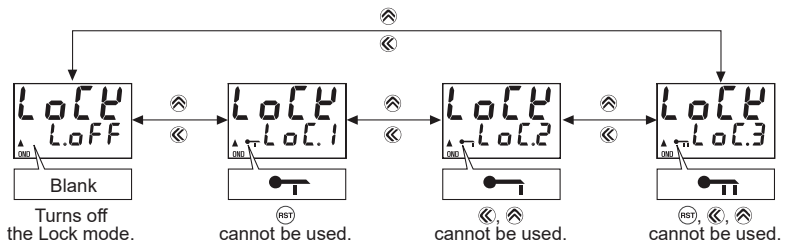

3) Press  $\text{MD}$  to complete key lock setting and move to the next mode.

4) If pressing  $\text{MD}$  for 3 sec in any function setting mode, it will return to Run mode.

※Factory default for LE4S is *LoFF* and Factory default for LE4SA is *LoC.1*.

※Key Lock function

Display	Function
<i>LoFF</i>	Turns off the key Lock mode.
<i>LoC.1</i>	$\text{RST}$ cannot be used.
<i>LoC.2</i>	$\leftarrow$ , $\rightarrow$ cannot be used.
<i>LoC.3</i>	$\text{RST}$ , $\leftarrow$ , $\rightarrow$ cannot be used.

## ■ Setting Time Change

Please set operation time according to following instruction as the setting is different depending on the output operation mode.

### ● Output operation mode: OND, ONDI, ONDI, INT, INTI, OFF D (LE4SA does not have no ONDI, INTI, OFF D.)

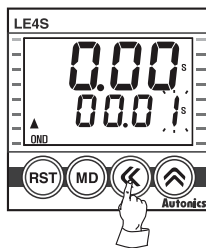

[Figure1]

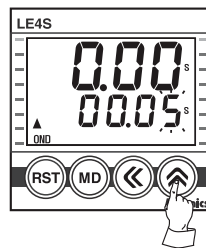

[Figure2]

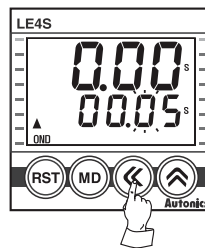

[Figure3]

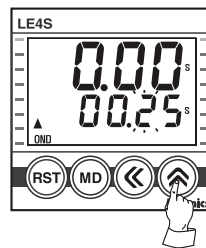

[Figure4]

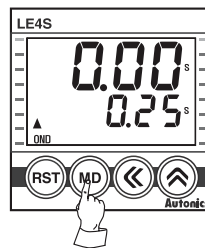

[Figure5]

1) Press  $\leftarrow$  in RUN mode, time set digits will flash. [Figure 1]

2) Change setting time by using  $\leftarrow$  or  $\rightarrow$ . [Figure 2,3,4]

-  $\leftarrow$  : Shift the setting digits.

-  $\rightarrow$  : Shift the flashing position value. As press  $\rightarrow$  once, it will increase by 1digit,

number will increase faster by press  $\rightarrow$  for over 2 sec

3) When the setting is completed, it will be stored and return to RUN mode by pressing  $\text{MD}$  [Figure 5]

## • Output operation mode: FK, FK I

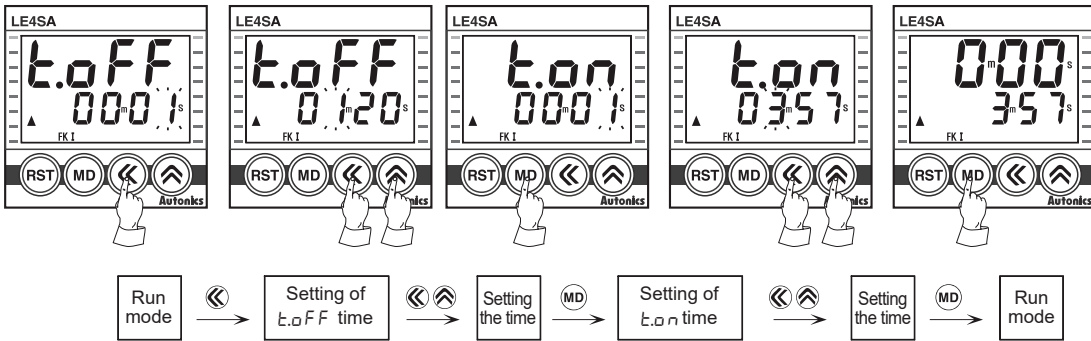

## • Output operation mode: ON OFF D, ON OFF D I (LE4S only)

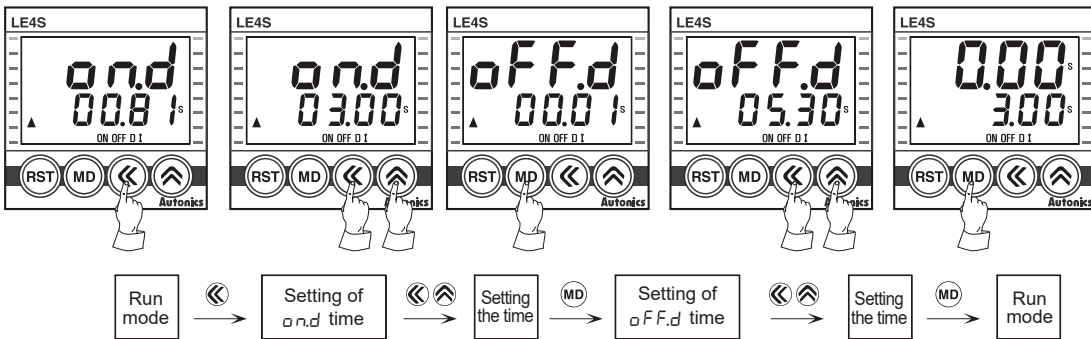

## • Output operation mode: λ-Δ, T, TI (LE4SA only)

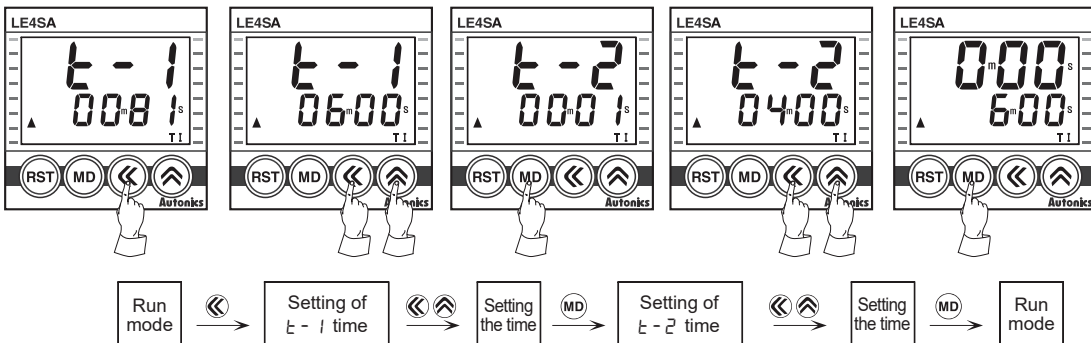

※ It is able to change the setting time during the time progressing, but be sure about the time progressing while changing of the time.

※ If pressing **MD** while setting time is shorter than min. setting time, setting value will be flickering three times and it will be returned to setting mode again, not to RUN mode.

※ If there is no additional key operations in 60 sec after entering into setting mode, it will be return to RUN mode. (set value is not stored.)

※ Min. setting time: 0.01 sec

(in case of: *o.n.d*, *o.n.d.1*, *o.n.d.2* modes, it is able to set "0" since no min. setting time is applied.)

SENSORS

CONTROLLERS

MOTION DEVICES

SOFTWARE

(J) Temperature Controllers

(K) SSRs

(L) Power Controllers

(M) Counters

(N) Timers

(O) Digital Panel Meters

(P) Indicators

(Q) Converters

(R) Digital Display Units

(S) Sensor Controllers

(T) Switching Mode Power Supplies

(U) Recorders

(V) HMIs

(W) Panel PC

(X) Field Network Devices

# LE4S Series

## LE4S Output Operation Mode

T = Setting time, T > Ta

Mode	Time chart	Operation
<b>[OND]</b> <b>OND</b>		<p>T = set time</p>
<b>ON Delay</b>  T > Ta	<ol style="list-style-type: none"> <li>1. Timing operation starts when START signal is ON at status of power on.</li> <li>2. Output will be ON when timing operation is progressed up to the setting time. Display value will be HOLD. (⊙ position)</li> <li>3. When RESET signal is ON, display value and output will be reset. (Ⓜ position)</li> <li>4. If RESET signal is OFF while START signal is ON, "STEP 1" will be restarted. (Ⓜ position)</li> <li>5. When START signal is OFF, display value and output will be reset. (Ⓜ position)</li> </ol>	
<b>[OND.1]</b> <b>ONDI</b>		<p>T = set time</p>
<b>ON Delay 1</b>  T > Ta	<ol style="list-style-type: none"> <li>1. Timing operation starts when START signal is ON at status of power on.</li> <li>2. Output will be ON when timing operation is progressed up to the setting time. Display value will be HOLD. (⊙ position)</li> <li>3. Even though START signal is applied repeatedly, only the initial signal is recognized. (Ⓜ position)</li> <li>4. When RESET signal is ON, display value and output will be reset. (Ⓜ position)</li> </ol>	
<b>[OND.2]</b> <b>ONDII</b>		<p>Tout = output time T = set time</p>
<b>ON Delay 2 (One-shot output)</b>  T > Ta	<ol style="list-style-type: none"> <li>1. Timing operation starts when START signal is ON at status of power on.</li> <li>2. Time limit output will be ON and goes OFF during T<sub>out</sub> setting time when timing operation is progressed up to the setting time. Display value will be HOLD. (⊙ position)</li> <li>3. When RESET signal is ON, display value and output will be reset.</li> <li>4. If START signal is applied while time is progressing, Timing operation will be reset and started again. (Ⓜ position)</li> <li>5. T<sub>out</sub> setting range: 0.01 sec to 99.99 sec</li> </ol>	
<b>[FLP]</b> <b>FK</b>		<p>Ton, Toff = set time <b>Enables to set Ton and Toff time differently.</b></p>
<b>Flicker (Toff operation precedes)</b>  Ton, Toff > Ta	<ol style="list-style-type: none"> <li>1. If START signal is ON, output will be repeatedly OFF during T<sub>off</sub> setting time and will be OFF during T<sub>on</sub> setting time when power is ON.</li> <li>2. When RESET signal is ON, display value and output will be reset.</li> <li>3. If RESET signal is OFF when START signal is ON, "STEP 1" will be restarted.</li> <li>4. When START signal is OFF, display value and output will be reset.</li> <li>5. It is able to set each Toff time and Ton time separately. In [FLP] mode, timing operation starts with Toff.</li> </ol>	
<b>[FLP.1]</b> <b>FK.1</b>		<p>Ton, Toff = set time <b>Enables to set Ton and Toff time differently.</b></p>
<b>Flicker 1 (Ton operation precedes)</b>  Ton, Toff > Ta	<ol style="list-style-type: none"> <li>1. If START signal is ON, output will be repeatedly ON during T<sub>on</sub> setting time and will be OFF during T<sub>off</sub> setting time when power is ON.</li> <li>2. Even though START signal is applied repeatedly, only the initial signal is recognized. (Ⓜ position)</li> <li>3. When START signal is ON, display value and output will be reset. If START signal is ON, it will be restarted.</li> <li>4. It is able to set each Toff time and Ton time separately. In [FLP.1] mode, timing operation starts with Ton.</li> </ol>	

※Initial status: UP mode-display value is "0", output is "OFF". DOWN mode-display value is "setting time", output is "OFF".

## LE4S Output Operation Mode

T = Setting time, T > Ta

Mode	Time chart	Operation
<b>[ n t ]</b> <b>INT</b>  <b>Interval</b>  T > Ta	<p>1. Output will be ON when START signal is ON at status of power on and Timing operation starts.            2. Output will be OFF when timing operation is progressed up to the setting time. Display value will be HOLD.            3. When RESET signal is ON, display value and output will be reset. (① position)            4. If RESET signal is OFF when START signal is ON, 'STEP 1' will be restarted.            5. When START signal is OFF, display value and output will be reset. (② position)</p>	<p>T = set time</p>
<b>[ n t . 1 ]</b> <b>INT1</b>  <b>Interval 1</b>  T > Ta	<p>1. Output will be ON when START signal is ON at status of power on and Timing operation starts.            2. Output will be OFF when timing operation is progressed up to the setting time. Display value will be HOLD.            3. Even though START signal is applied repeatedly, only the initial signal is recognized. (① position)            4. If START signal is ON after timing operation is progressed up to the setting time, Output will be ON and setting time will be reset and then timing setting starts.            5. When RESET signal is ON, display value and output will be reset. (② position)</p>	<p>T = set time</p>
<b>[ n F d ]</b> <b>ON OFF D</b>  <b>ON-OFF Delay</b>  T > Ta	<p>1. If START signal is ON when power is on, Output will be ON when timing operation is progressed up to the Ton setting time (On-Delay). If START signal is OFF, output will be ON when timing operation is progressed up to the Toff setting time (OFF-Delay).            2. If START signal is applied repeatedly, output is ON and display value will be reset. (① position)            3. When RESET signal is ON, display value and output will be reset. When RESET signal is OFF while START signal is ON, it will be operating as On-Delay. (② position)            4. It is able to set each Toff time and Ton time separately.</p>	<p>Ton, Toff = set time</p>
<b>[ n F d . 1 ]</b> <b>ON OFF D1</b>  <b>ON-OFF Delay 1</b>  T > Ta	<p>1. If START signal is ON when power is on, timing operation starts. Output will be ON when timing operation is progressed up to the Ton setting time (On-Delay). If START signal is OFF, output will be ON when timing operation is progressed up to the Toff setting time (OFF-Delay).            2. Output will be ON when START signal is ON and goes OFF during setting time and display value will be reset. (① position)            3. Output will be OFF when START signal is OFF and goes ON during setting time and display value will be reset. (② position)            4. When RESET signal is ON, display value and output will be reset. When RESET signal is OFF while START signal is ON, it will be operating as On-Delay. (③ position)            5. It is able to set each Toff time and Ton time separately.</p>	<p>Ton, Toff = set time</p>
<b>[ a F d ]</b> <b>OFF D</b>  <b>OFF Delay</b>  T > Ta	<p>1. If START signal is ON when power is on, output will be ON.            2. When START signal is OFF, timing operation starts. Output will be OFF when timing operation is progressed up to the setting time. Display value will be HOLD.            3. When RESET signal is ON, display value and output will be reset.</p>	<p>T = set time</p>

※Initial status: UP mode-display value is "0", output is "OFF". DOWN mode-display value is "setting time", output is "OFF".

SENSORS
CONTROLLERS
MOTION DEVICES
SOFTWARE
(J) Temperature Controllers
(K) SSRs
(L) Power Controllers
(M) Counters
(N) Timers
(O) Digital Panel Meters
(P) Indicators
(Q) Converters
(R) Digital Display Units
(S) Sensor Controllers
(T) Switching Mode Power Supplies
(U) Recorders
(V) HMIs
(W) Panel PC
(X) Field Network Devices

# LE4S Series

## LE4SA Output Operation Mode

T = Setting time, T > Ta, Rt = Reset time

Mode	Time chart	Operation
[OND]		<p>T = set time</p>
ON Delay	<ol style="list-style-type: none"> <li>Timing operation starts when power is ON.</li> <li>Time limit output will be ON when timing operation is progressed up to the setting time. Display value will be HOLD.</li> <li>If selecting time limit 1c + instantaneous 1c mode, instantaneous output will be ON when power is ON and goes OFF when power is OFF.</li> <li>If pressing RESET key, display value and time limit output will be reset.</li> </ol>	
[OND2]		<p>Tout = output time T = set time</p>
ON Delay 2 (One-shot output)	<ol style="list-style-type: none"> <li>Timing operation starts when power is ON.</li> <li>Time limit output will be ON during Tout setting time and goes OFF when timing operation is progressed up to the setting time. Display value will be HOLD.</li> <li>If selecting time limit 1c + instantaneous 1c mode, instantaneous output will be ON when power is ON and goes OFF when power is OFF.</li> <li>If pressing RESET key, display value and time limit output will be reset.</li> <li>Tout setting range: 0.01 sec to 99.99 sec</li> </ol>	
[FLF]		<p>Ton, Toff = set time Enables to set Ton and Toff time differently.</p>
Flicker (Toff operation precedes)	<ol style="list-style-type: none"> <li>Control output will be repeatedly OFF during Toff setting time and will be ON during Ton setting time when power is ON.</li> <li>If selecting time limit 1c + instantaneous 1c mode, instantaneous output will be ON when power is ON and goes OFF when power is OFF.</li> <li>If pressing RESET key, display value and time limit output will be reset.</li> <li>It is able to set each Toff time and Ton time separately. In [FLF] mode, timing operation starts with Toff.</li> </ol>	
[FLF.1]		<p>Ton, Toff = set time Enables to set Ton and Toff time differently.</p>
Flicker 1 (Ton operation precedes)	<ol style="list-style-type: none"> <li>Control output will be repeatedly ON during Ton setting time and will be OFF during Toff setting time when power is ON.</li> <li>If selecting time limit 1c + instantaneous 1c mode, instantaneous output will be ON when power is ON and goes OFF when power is OFF.</li> <li>If pressing RESET key, display value and time limit output will be reset.</li> <li>It is able to set each Ton time and Toff time separately. In [FLF.1] mode, timing operation starts with Ton.</li> </ol>	

※Initial status: UP mode-display value is "0", output is "OFF". DOWN mode-display value is "setting time", output is "OFF".

※Instantaneous contact (OUT2) will be returned when power is off.

※RESET key is locked for default set and release the lock to use.

## LE4SA Output Operation Mode

Rt: Reset time (min. 500ms)

Mode	Time chart	Operation
<p>[5 - d]</p> <p>INT</p> <p>Interval</p>	<p>1. Time limit output will be ON when power is ON and Timing operation starts.                  2. Time limit output will be OFF when timing operation is progressed up to the setting time. Display value will be HOLD.                  3. If selecting time limit 1c + instantaneous 1c mode, instantaneous output will be ON when power is ON and goes OFF when power is OFF.                  4. If pressing RESET key, display value and time limit output will be reset.</p>	<p>T = set time</p>
<p>[5 - d]</p> <p>λ-Δ</p> <p>Star-Delta</p> <p>(output will be set automatically as Time limit 2c)</p>	<p>1. λ contact will be ON when power is ON and Timing operation starts.                  2. λ contact will be OFF when timing operation is progressed up to the T1 setting time. Timing operation will be reset and started again.                  3. Δ contact will be ON when timing operation is progressed up to the T2 switching time. Display value will be HOLD.                  4. If pressing RESET key, display value and λ - Δ contacts will be reset.                  5. It is able to set each T1 and T2 time separately.</p>	<p>×T1: set time                  T2: switching time (λ-Δ switching time)</p>
<p>[5 - d]</p> <p>T</p> <p>Twin</p> <p>(output will be set automatically as Time limit 2c)</p>	<p>1. T1 contact will be ON when power is ON and Timing operation starts.                  2. T1 contact will be OFF and T2 contact will be ON when timing operation is progressed up to the T1 setting time. Timing operation will be reset and started again. T2 contact will be OFF when timing operation is progressed up to the T2 setting time. Display value will be HOLD.                  3. If pressing RESET key, display value and T1, T2 contacts will be reset.                  4. It is able to set each T1 and T2 time separately.</p>	<p>T1, T2 = set time</p> <p>Enables to set T1 and T2 time same or differently</p>
<p>[5 - d]</p> <p>T1</p> <p>Twin 1</p> <p>(output will be set automatically as Time limit 2c)</p>	<p>1. Timing operation starts when power is ON.                  2. T1 contact will be ON when timing operation is progressed up to the T1 setting time. Timing operation will be reset and started again.                  3. T2 contact will be ON when timing operation is progressed up to the T2 setting time. Display value will be HOLD.                  4. If pressing RESET key, display value and T1 and T2 contacts will be reset.                  5. It is able to set each T1 and T2 time separately.</p>	<p>T1, T2 = set time</p> <p>Enables to set T1 and T2 time same or differently</p>

×Initial status: UP mode-display value is "0", output is "OFF". DOWN mode-display value is "setting time", output is "OFF".  
 ×Instantaneous contact (OUT2) will be returned when power is off.  
 ×RESET key is locked for default set and release the lock to use.

SENSORS
CONTROLLERS
MOTION DEVICES
SOFTWARE
(J) Temperature Controllers
(K) SSRs
(L) Power Controllers
(M) Counters
(N) Timers
(O) Digital Panel Meters
(P) Indicators
(Q) Converters
(R) Digital Display Units
(S) Sensor Controllers
(T) Switching Mode Power Supplies
(U) Recorders
(V) HMIs
(W) Panel PC
(X) Field Network Devices

# LE4S Series

## ■ Proper Usage

- Follow instructions in 'Proper Usage'. Otherwise, it may cause unexpected accidents.
- When supplying or turning off the power, use a switch or etc. to avoid chattering.
- Install a power switch or circuit breaker in the easily accessible place for supplying or disconnecting the power.
- In order to block peripheral current, use isolation transformer which of secondary part is not grounded as (Figure 1) to supply power to the external input device.

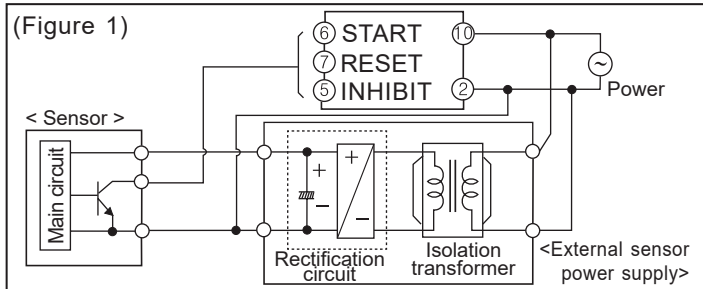

- Do not connect two or more timers with only one input contact or transistor simultaneously.
- Keep away from high voltage lines or power lines to prevent inductive noise.  
In case installing power line and input signal line closely, use line filter or varistor at power line and shielded wire at input signal line.  
Do not use near the equipment which generates strong magnetic force or high frequency noise.
- This unit may be used in the following environments.
  - ① Indoors (in the environment condition rated in 'Specifications')
  - ② Altitude max. 2,000m
  - ③ Pollution degree 2
  - ④ Installation category II