

ignion 

Your innovation.
Accelerated.

ONE mXTEND™: THE IoT ANTENNA FOR JUST ABOUT EVERY DEVICE

USER MANUAL
ONE mXTEND™ (NN02-201)

ONE mXTEND[™]

The IoT antenna for just about every device



NN02-201

ONE mXTEND[™] | 5G | Cellular IoT | Wi-Fi 6E

Operating range: 800 - 10600 MHz

Best for: 824 - 7125 MHz

Dimensions: 7.0 mm x 3.0 mm x 1.0 mm

What is ONE mXTEND ?

ONE mXTEND is the smallest Virtual Antenna[™] chip for both **cellular** and **unlicensed** IoT wireless devices (ISM). Featuring a size of 7 x 3 x 1mm, this antenna chip has been designed to fit just about every **IoT device**, particularly *small, light, entry level products*. **ONE mXTEND** is enabled by Virtual Antenna[™] technology, thus featuring the unique properties of this class of products: versatile tunability within the broadest operating range in the market: 800 MHz up to 10.600 MHz. This makes the perfect product for **multiband connectivity** at cellular IoT, including connectivity within several **2G, 3G, 4G** and **5G** bands, but also for unlicensed regions of the spectrum such as for instance the entire range of **WiFi-6E**.

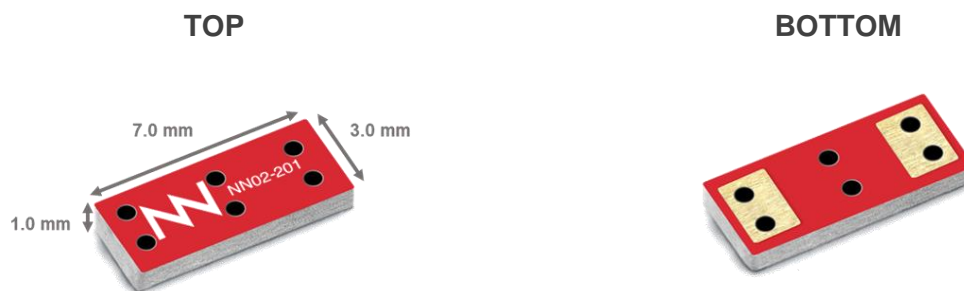

Material: The ONE mXTEND[™] antenna booster is built on glass epoxy substrate.





What is ONE mXTEND used for ?

ONE mXTEND is suitable for embedding an antenna into any wireless device requiring an optimum performance in a small, cost-effective package. This includes IoT devices, routers and gateways, including,

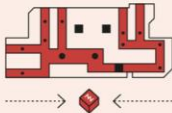

- Asset Trackers
- Smart Meters
- Wi-Fi Mesh Nodes
- Routers
- IoT Developer Kits
- Environmental Sensors
- Logistic Trackers
- Wearables
- Health sensors
- Animal Trackers
- Security sensors
- Service Buttons
- Point of Sales
- Vending Machines

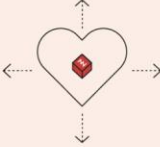
What differentiates ONE mXTEND from other chip antennas?

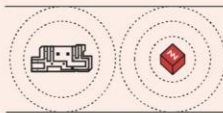
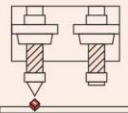
Like every other Virtual Antenna™ product, ONE mXTEND is frequency neutral, meaning that its frequency response is not determined by the antenna component but designed by the electronics engineer. Virtual Antenna™ technology enables packaging the desired multiband performance in the smallest ever form factor, which enables the whole mXTEND range of components to become tiny, off-the-shelf, surface-mount (SMD) electronic chips. This makes mXTEND components easy to be integrated in just about any IoT device through a shorter and easier design cycle and with a much more robust, reliable and cost-effective manufacturing process.

 <p>Off-the-shelf Ready to be delivered 'as is' with no need for customization.</p>	 <p>Up to 10 times smaller A booster can be 5³mm³ providing the same connectivity.</p>	 <p>Versatility A phone can be designed with several architectures yet still using the same component.</p>	 <p>Scalability The 'heart' of the design can be reused across multiple device models.</p>
 <p>Modular Modules or standard building blocks can be re-used in the design of multiple devices.</p>	 <p>Multiband A single antenna provides connectivity in 2G, 3G and 4G band.</p>	 <p>Full performance The same performance in a much smaller, off-the-shelf and versatile component.</p>	 <p>Pick & place No manual assembly is needed, only a conventional SMT machine.</p>

Click and select an application that fits your project:

<u>ONE mXTEND FOR CELLULAR IoT</u>		(824 MHz – 2170 MHz)
<u>ONE mXTEND FOR 5G</u>		(2500 MHz – 5000 MHz)
<u>ONE mXTEND FOR WiFi-6E</u>		(2500 MHz – 5000 MHz)

Click to view other useful ONE mXTEND guidelines:

-
- HOW TO EMBED A VIRTUAL ANTENNA
 - MECHANICAL SPECIFICATIONS
 - ASSEMBLY AND MANUFACTURING
 - PACKAGING
-

Chapter Index

1. HOW TO EMBED A VIRUTAL ANTENNA.....	5
2. ONE mXTEND FOR CELLULAR IoT.....	8
3. ONE mXTEND FOR 5G.....	19
4. ONE mXTEND FOR Wi-Fi 6E.....	24
5. MECHANICAL SPECIFICATIONS.....	36
6. ASSEMBLY AND MANUFACTURING.....	38
7. PACKAGING.....	40

How to embed a Virtual Antenna

Design with Virtual Antenna in 1-2-3

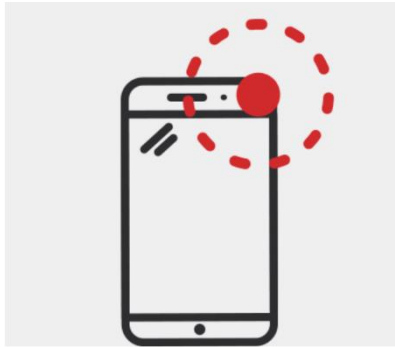

STEP 1: Place the antenna component

1. Select one corner of your PCB
2. Ensure your ground plane meets the ONE mXTEND clearance area restrictions
3. Respect a keep out space around the booster. Keep at least 5mm distance from metallic objects

Look [here](#) for an example on placing the ONE mXTEND

STEP 2: Design your matching network

1. Through a combination of inductors & capacitors obtain 50 Ohms of antenna impedance to optimize the transfer of energy to your antenna
2. It is critical to fine-tune your MN throughout the entirety the design process of achieve your desired frequency response

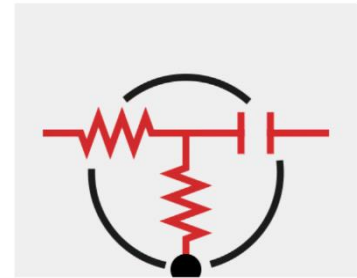

Look [here](#) for an example of a matching network we found in an ONE mXTEND application via simulation

STEP 3: Test your device



1. Perform a field test in which your antenna is placed in its final housing. Fine-tune the MN if needed.
2. Use a network analyzer to adjust mismatch
3. Test the antennas efficiency with an anechoic chamber

Look [here](#) for testing we did on our Evaluation Board, with the ONE mXTEND integrated in our Anechoic Chamber

<https://www.ignion.io/tutorials>

Scan QR code to
be taken to our
videos highlighting
these three easy





Need further help? Easy start with NN Wireless Fast Track

Do you need more help with your antenna for your device?

Use our **NN Wireless Fast Track service** and get your ready-to-test antenna design especially simulated for your platform **free of charge**¹, and in **24 hours**.

1. Fill out the form, submit it and receive a confirmation email.
2. Reply to the email. If you wish, attach any relevant design file.
3. Get your design in 24h.

<https://www.ignion.io/fast-track-project/>



Scan QR code
to be taken to
our Wireless
Fast Track
page

ONE mXTEND for Cellular IoT

The ONE mXTEND[™] is capable of enabling **2G, 3G, 4G and 5G easy cellular IoT worldwide connectivity**. In this application both **2G/3G** frequency bands in Europe and the U.S.A will be analyzed in two use cases of ONE mXTEND[™]. Using one of our evaluation boards, an example of a common ONE mXTEND[™] placement will be seen. Finally, a matching network will be selected, allowing us to test, obtain, and analyze the VSWR, total efficiency, gain and radiation patterns.

QUICK REFERENCE GUIDE (2G/3G-Europe)

Technical features	880 – 960 MHz	1710 – 2170 MHz
Average Efficiency	> 55%	> 65%
Peak Gain	1.3 dBi	1.7 dBi
VSWR	< 3:1	
Radiation Pattern	Omnidirectional	
Polarization	Linear	
Weight (approx.)	0.02 g.	
Temperature	-40 to +125 °C	
Impedance	50 Ω	
Dimensions (L x W x H)	7.0 mm x 3.0 mm x 1.0 mm	

Table 1 – Technical Features. Measures from the evaluation board (**Error! Reference source not found.**)

EVALUATION BOARD (2G/3G-Europe)

This evaluation board (part number: EB_NN02-201-2G/3G-Europe) integrates a UFL cable to connect the ONE mXTEND[™] antenna booster with the SMA connector. The ONE mXTEND[™] provides operation in two frequency regions, from 880 MHz to 960 MHz and from 1710 MHz to 2170 MHz, through a single input/output port.



Measure	mm
A	131
B	120
C	60
D	8.0
E	5.0
F	30
G	11

Tolerance: ±0.2 mm

D: Distance between the ONE mXTEND[™] antenna booster and the ground plane.

Material: The evaluation boards are built on FR4 substrate. Thickness is 1 mm.

Clearance Area: 30 mm x 8.0 mm (FxG)

Figure 1 – EB_NN02-201-2G_3G-Europe. Evaluation board providing operation at 2G/3G-Europe band (880 – 960 MHz and 1710 – 2170 MHz).

This product and its use are protected by at least one or more of the following [patents and patent applications](#) PAT. US 62/529032; and other domestic and international patents pending. Additional information about patents related to this product is available at www.ignion.io/virtual-antenna/.

MATCHING NETWORK

ONE mXTEND™ antenna booster needs a matching network to connect to your 2G and 3G receiver. This section describes a suitable matching network (**Error! Reference source not found.**) for ONE mXTEND™ and the resulting product specs when measured in the reference evaluation board (EB_NN02-201-2G/3G-Europe) (**Error! Reference source not found.**). Please note that different tracking devices with different form factors, RF ground planes and nearby components may need a different matching network.

If you need assistance to design your matching network, please contact support@ignion.io, or try our free-of-charge¹ **NN Wireless Fast-Track** design service, you will get your chip antenna design including a custom matching network for your device in 24h¹. Other information related to NN's range of R&D services is available at: <https://www.ignion.io/rdservices/>

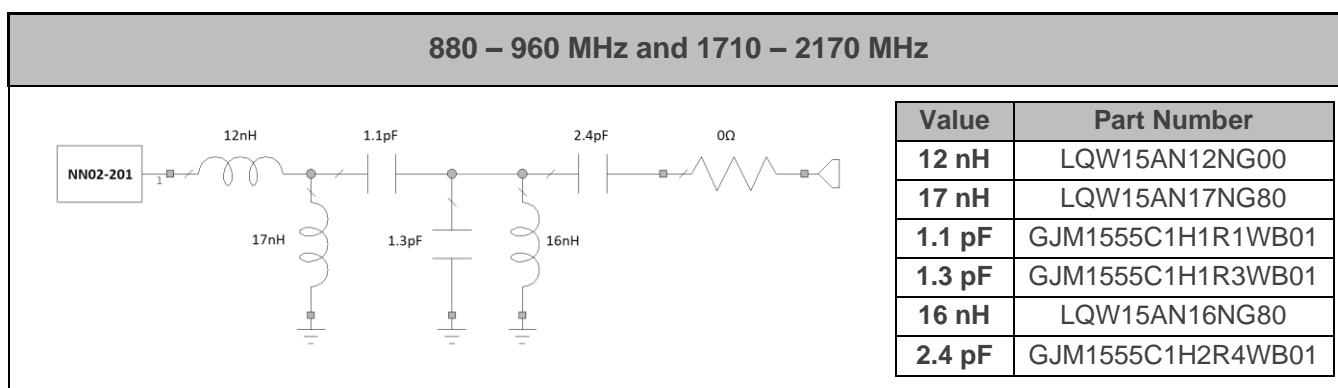

Figure 2 – Matching network implemented in the evaluation board (Error! Reference source not found.**).**

To ensure optimal results, the use of high-quality factor (Q) and tight tolerance components is highly recommended (e.g. Murata components with part numbers as in **Error! Reference source not found.**). The antenna performance is always conditioned by its operating environment so that different devices with different printed circuit board sizes, components nearby the antenna, LCD's, batteries, covers, connectors, etc. affect the antenna performance. Accordingly, it is highly recommended placing pads compatible with 0402 and 0603 SMD components for a matching network as close as possible to the feeding point of the antenna element. Do it in the ground plane area, not in the clearance area. By tuning the matching network in your final design with your final surrounding components (batteries, displays, covers, etc.) you will be able to optimize the antenna performance without changing the antenna part.

¹ See terms and conditions for a free NN Wireless Fast-Track service in 24h at: <https://www.ignion.io/fast-track-project/>

VSWR AND TOTAL EFFICIENCY

VSWR (Voltage Standing Wave Ratio) and Total Efficiency versus Frequency (GHz).

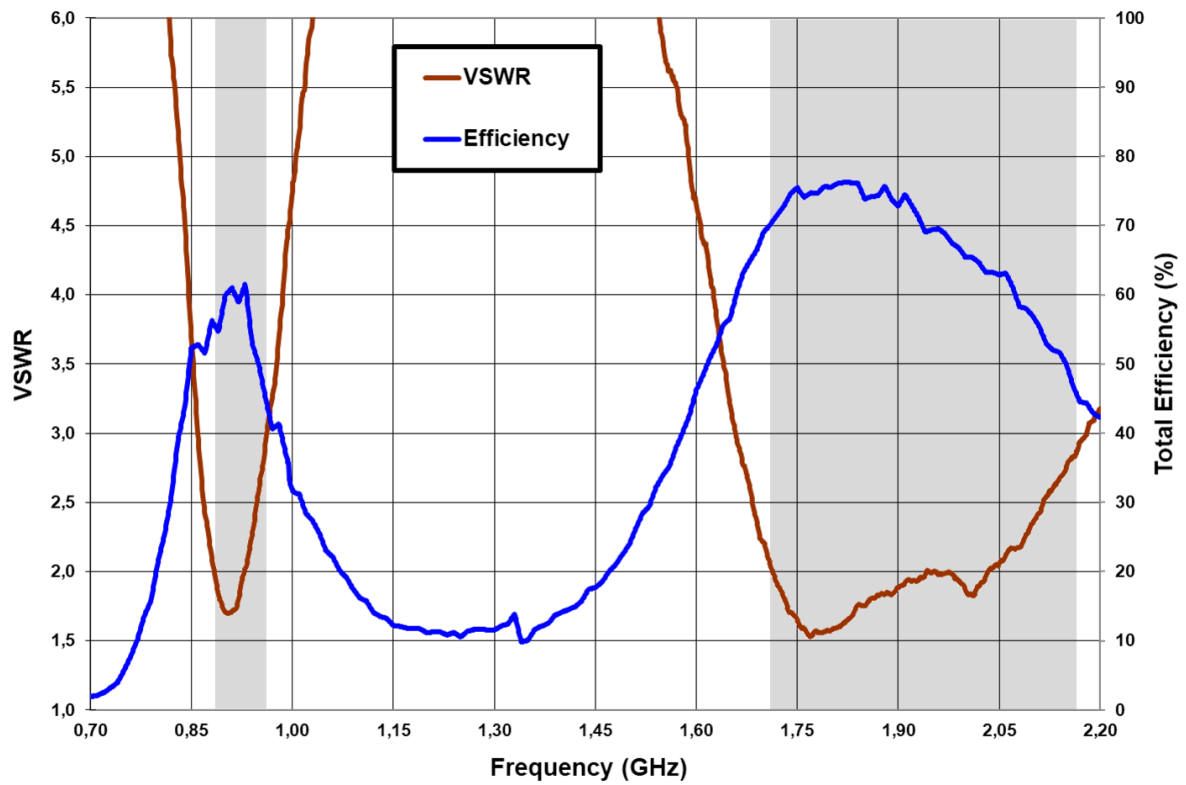
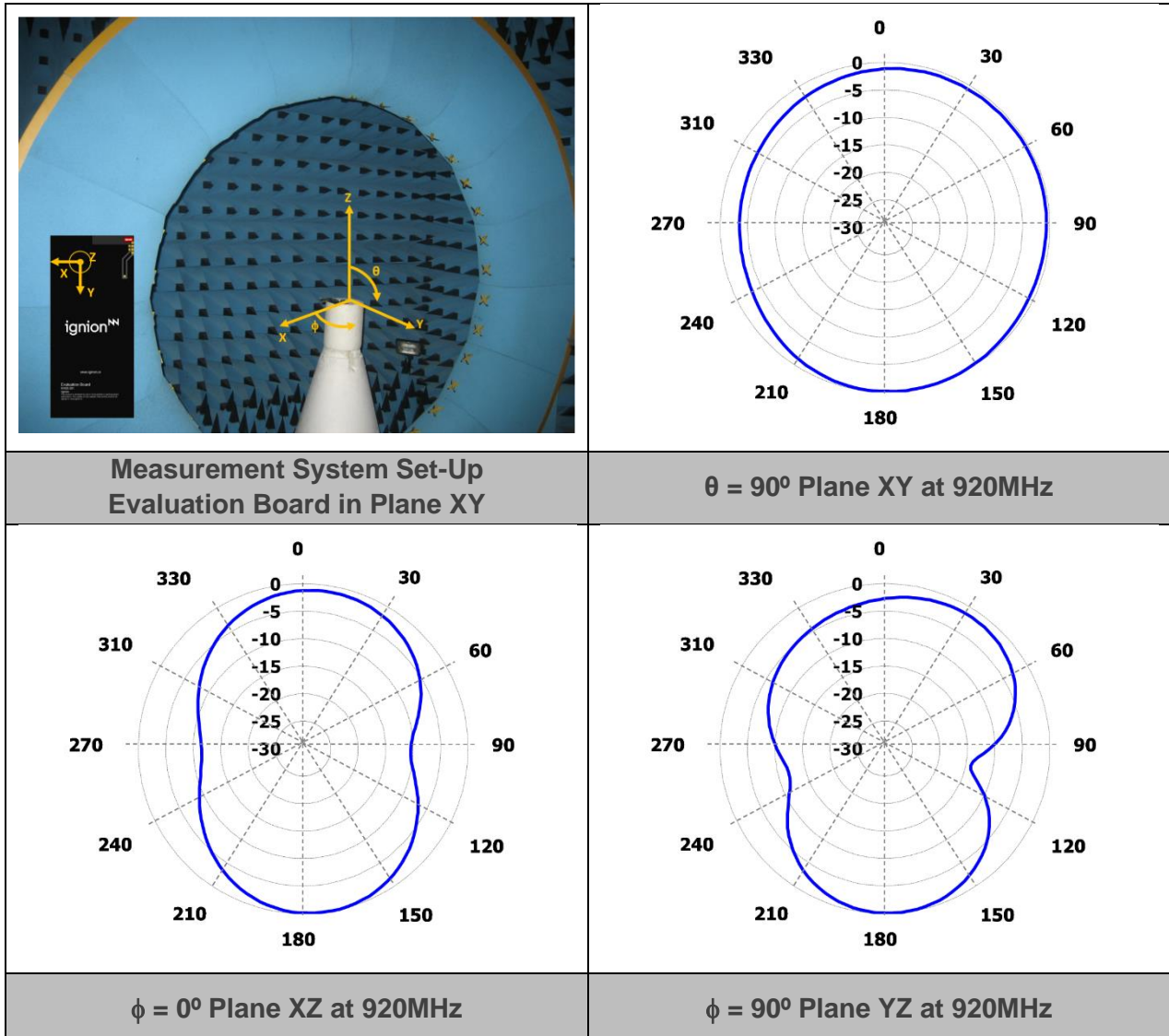

Figure 3 – VSWR and Total Efficiency at 2G/3G-Europe band (880 – 960 MHz and 1710 – 2170 MHz) (from the evaluation board (Error! Reference source not found.)).

RADIATION PATTERNS (880 MHz – 960 MHz), GAIN, AND EFFICIENCY



Gain	Peak Gain	1.3dBi
	Average Gain across the band	0.7dBi
	Gain Range across the band (min, max)	-0.2dBi \leftrightarrow 1.3dBi
Efficiency	Peak Efficiency	61.5%
	Average Efficiency across the band	56.2%
	Efficiency Range across the band (min, max)	45.3% - 61.5%

Table 2 – Antenna Gain and Total Efficiency from the evaluation board (Error! Reference source not found.) 2G/3G-Europe band (880 – 960 MHz). Measures made in the Satimo STARGATE 32 anechoic chamber.

RADIATION PATTERNS (1710 MHz – 2170 MHz), GAIN, AND EFFICIENCY

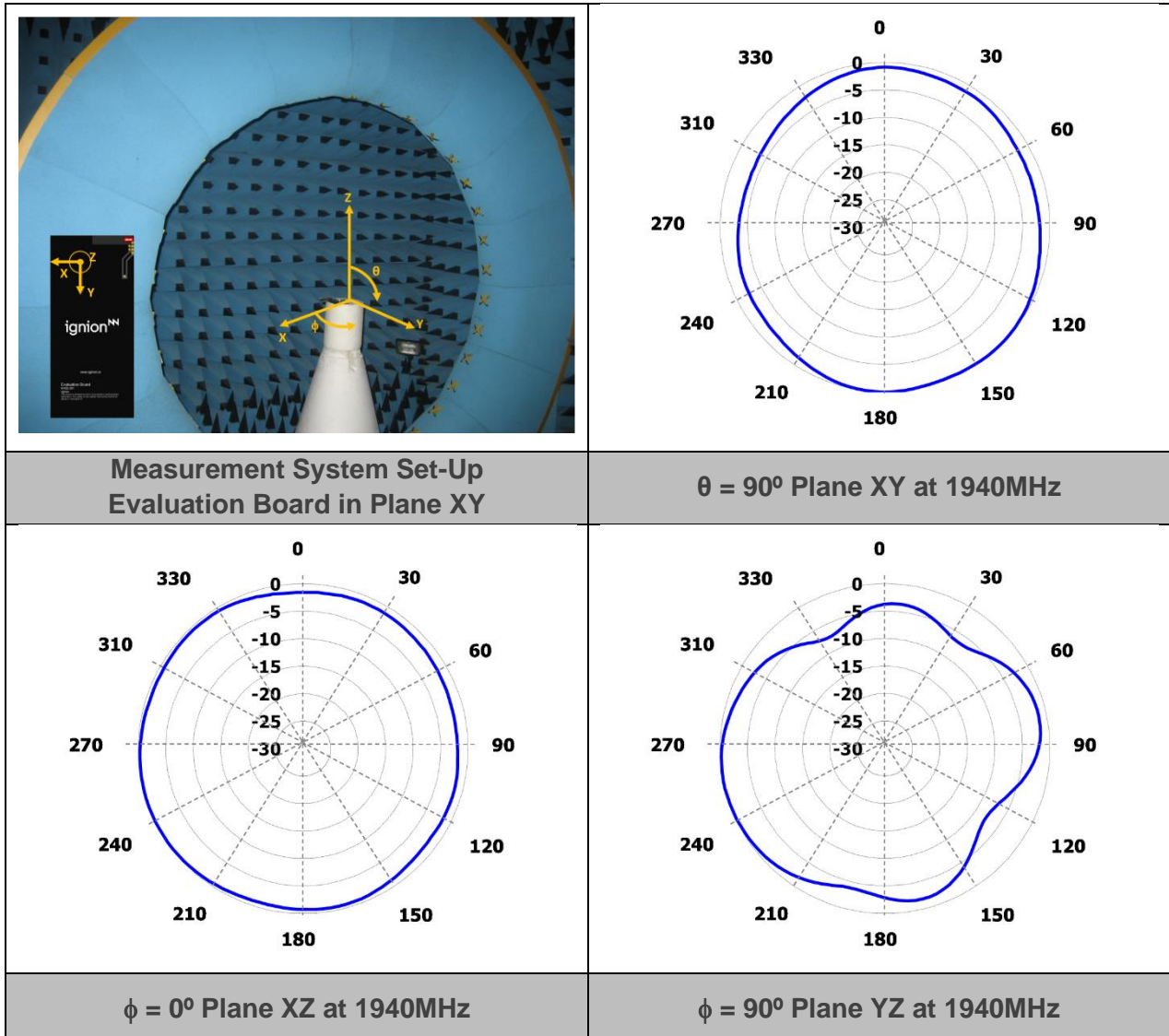

Gain	Peak Gain	1.7dBi
	Average Gain across the band	0.9dBi
	Gain Range across the band (min, max)	-0.9Bi <-> 1.7dBi
Efficiency	Peak Efficiency	76.2%
	Average Efficiency across the band	67.3%
	Efficiency Range across the band (min, max)	44.5% - 73.4%

Table 3 – Antenna Gain and Total Efficiency from the evaluation board (Error! Reference source not found.) 2G/3G-Europe band (1710 – 1880 MHz). Measures made in the Satimo STARGATE 32 anechoic chamber.

QUICK REFERENCE GUIDE (2G/3G-USA)

Technical features	824 – 894 MHz	1850 – 2170 MHz
Average Efficiency	> 65%	> 70%
Peak Gain	1.9	2.0
VSWR	< 3:1	
Radiation Pattern	Omnidirectional	
Polarization	Linear	
Weight (approx.)	0.02 g.	
Temperature	-40 to +125 °C	
Impedance	50 Ω	
Dimensions (L x W x H)	7.0 mm x 3.0 mm x 1.0 mm	

Table 4 – Technical Features. Measures from the evaluation board (Error! Reference source not found.).

EVALUATION BOARD (2G/3G-USA)

This evaluation board (part number: EB_NN02-201-2G/3G-USA) integrates a UFL cable to connect the ONE mXTEND™ antenna booster with the SMA connector. The ONE mXTEND™ provides operation in two frequency regions, from 880 MHz to 894 MHz and from 1850 MHz to 2170 MHz, through a single input/output port.



Measure	mm
A	131
B	120
C	60
D	8.0
E	5.0
F	30
G	11

Tolerance: ±0.2 mm

D: Distance between the ONE mXTEND™ antenna booster and the ground plane.

Material: The evaluation boards are built on FR4 substrate. Thickness is 1 mm.

Clearance Area: 30 mm x 8.0 mm (FxG)

Figure 4 – EB_NN02-201-2G/3G-USA evaluation board providing operation at 2G/3G-USA band (824 – 894 MHz and 1850 – 2170 MHz).

This product and its use are protected by at least one or more of the following [patents and patent applications](#) PAT. US 62/529032; and other domestic and international patents pending. Additional information about patents related to this product is available at www.ignion.io/virtual-antenna/.

MATCHING NETWORK

ONE mXTEND[™] antenna booster needs a matching network to connect to your 2G and 3G receiver. This section describes a suitable matching network (Figure 5) for ONE mXTEND[™] and the resulting product specs when measured in the reference evaluation board (EB_NN02-201-2G_3G-USA) (Figure 4). Please note that different tracking devices with different form factors, RF ground planes and nearby components may need a different matching network.

If you need assistance to design your matching network, please contact support@ignion.io, or try our free-of-charge² **NN Wireless Fast-Track** design service, you will get your chip antenna design including a custom matching network for your device in 24h². Other related to NN's range of R&D services is available at: <https://www.ignion.io/rdservices/>

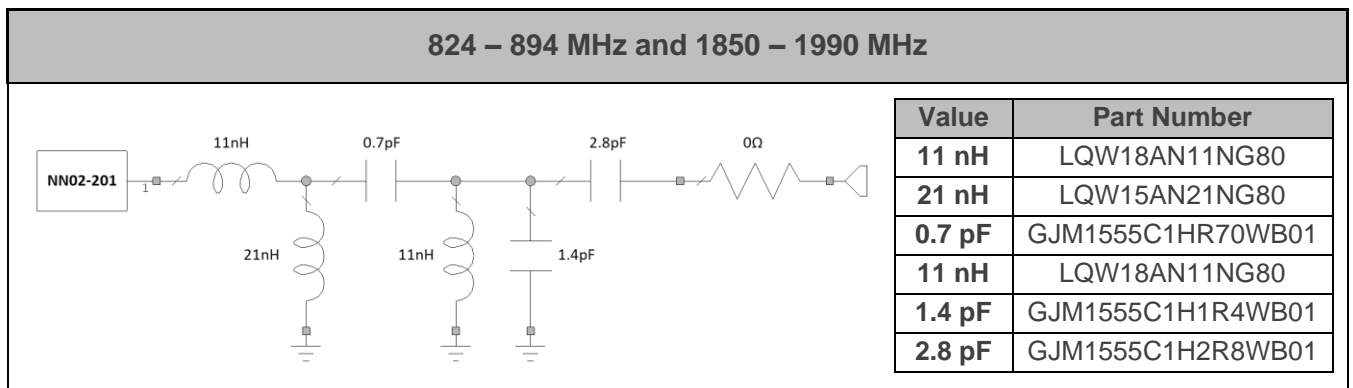

Figure 5 – Matching network implemented in the evaluation board (Error! Reference source not found.).

To ensure optimal results, the use of high-quality factor (Q) and tight tolerance components is highly recommended (e.g. Murata components with part numbers as in **Error! Reference source not found.**). The antenna performance is always conditioned by its operating environment so that different devices with different printed circuit board sizes, components nearby the antenna, LCD's, batteries, covers, connectors, etc. affect the antenna performance. Accordingly, it is highly recommended placing pads compatible with 0402 and 0603 SMD components for a matching network as close as possible to the feeding point of the antenna element. Do it in the ground plane area, not in the clearance area. By tuning the matching network in your final design with your final surrounding components (batteries, displays, covers, etc.) you will be able to optimize the antenna performance without changing the antenna part.

² See terms and conditions for a free NN Wireless Fast-Track service in 24h at: <https://www.ignion.io/fast-track-project/>

VSWR AND TOTAL EFFICIENCY

VSWR (Voltage Standing Wave Ratio) and Total Efficiency versus Frequency (GHz).

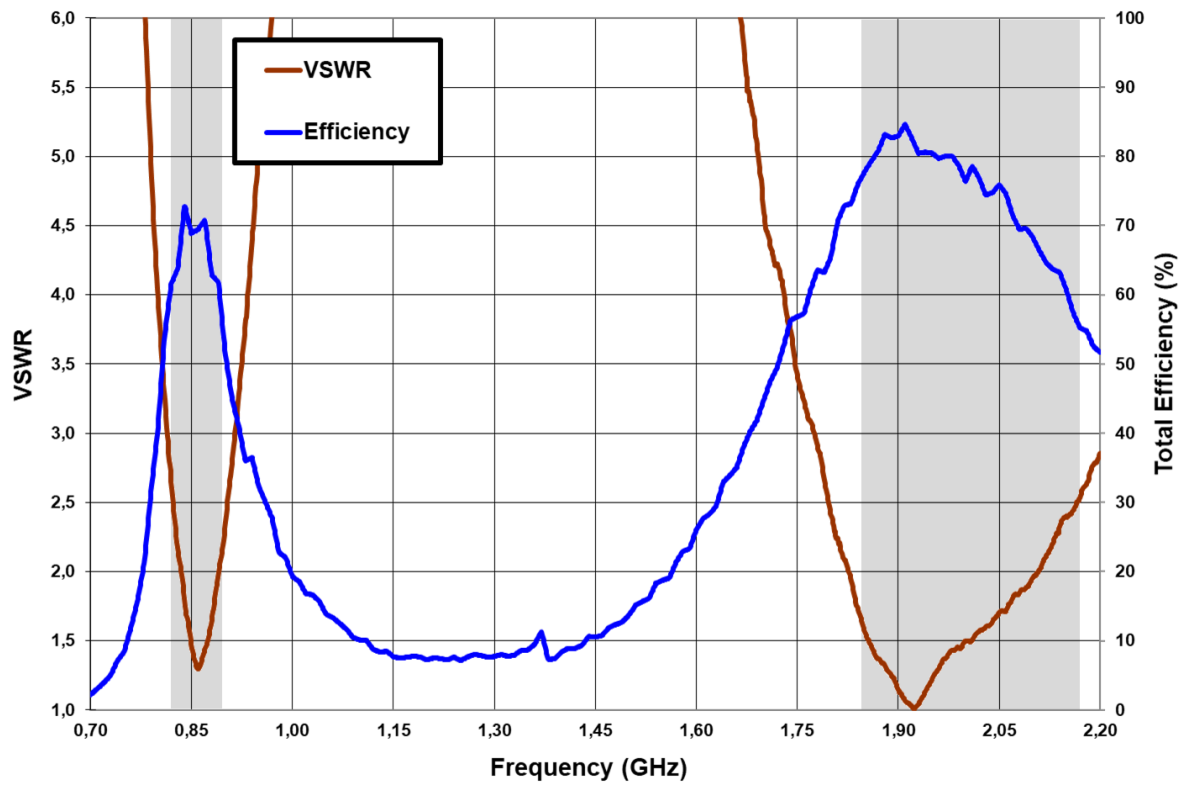
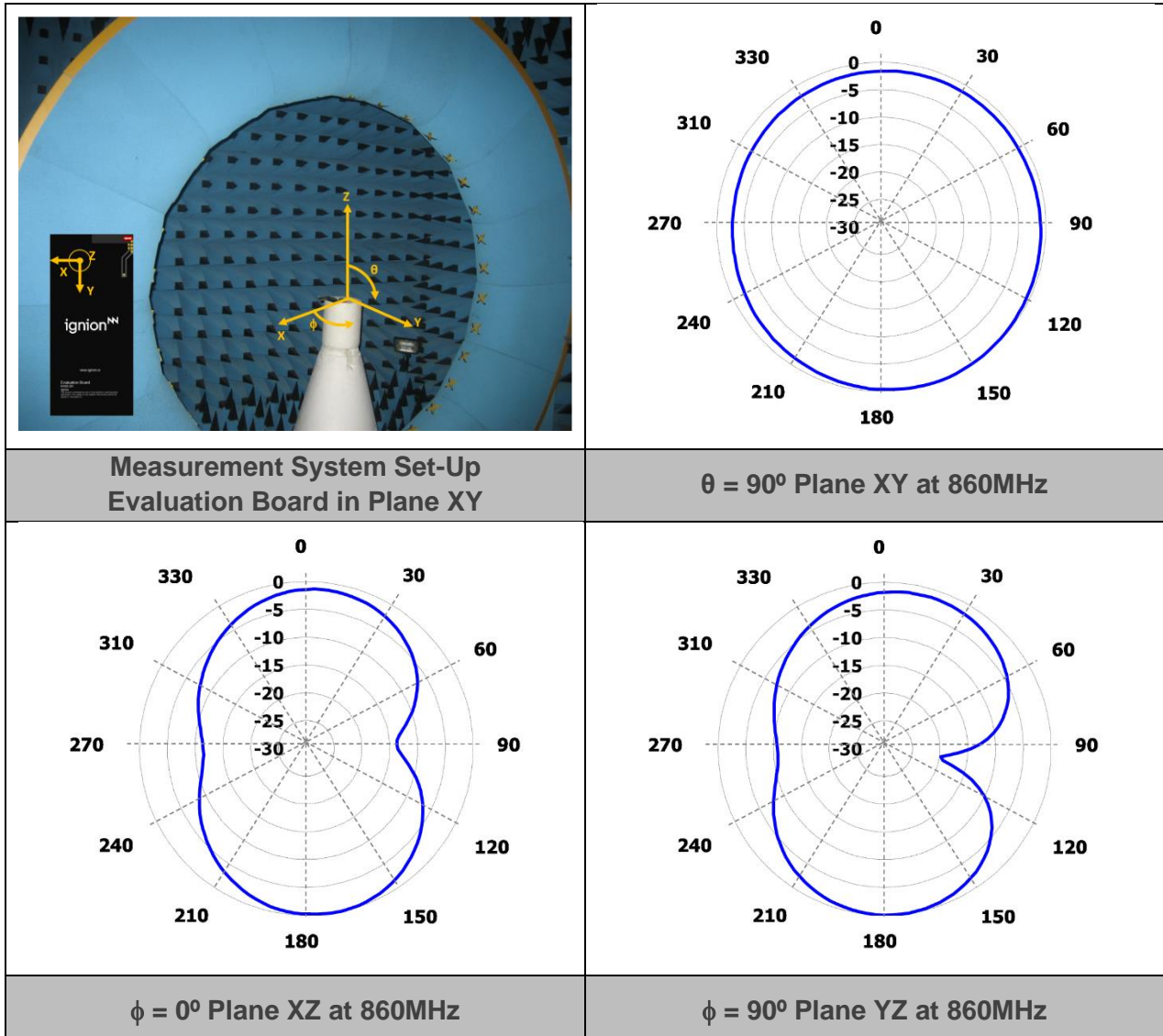

Figure 6 – VSWR and Total Efficiency at 2G/3G-USA band (824 – 894 MHz and 1850 – 2170 MHz) (from the evaluation board (Figure 4))

RADIATION PATTERNS (824 MHz – 894 MHz), GAIN, AND EFFICIENCY



Gain	Peak Gain	1.9dBi
	Average Gain across the band	1.4dBi
	Gain Range across the band (min, max)	0.7dBi <-> 1.9dBi
Efficiency	Peak Efficiency	72.7%
	Average Efficiency across the band	67.0%
	Efficiency Range across the band (min, max)	57.7 – 72.7%

Table 5 – Antenna Gain and Total Efficiency from the evaluation board (**Figure 4**) 2G/3G-USA band (824 – 894 MHz). Measures made in the Satimo STARGATE 32 anechoic chamber.

RADIATION PATTERNS (1850 MHz – 2170 MHz), GAIN, AND EFFICIENCY

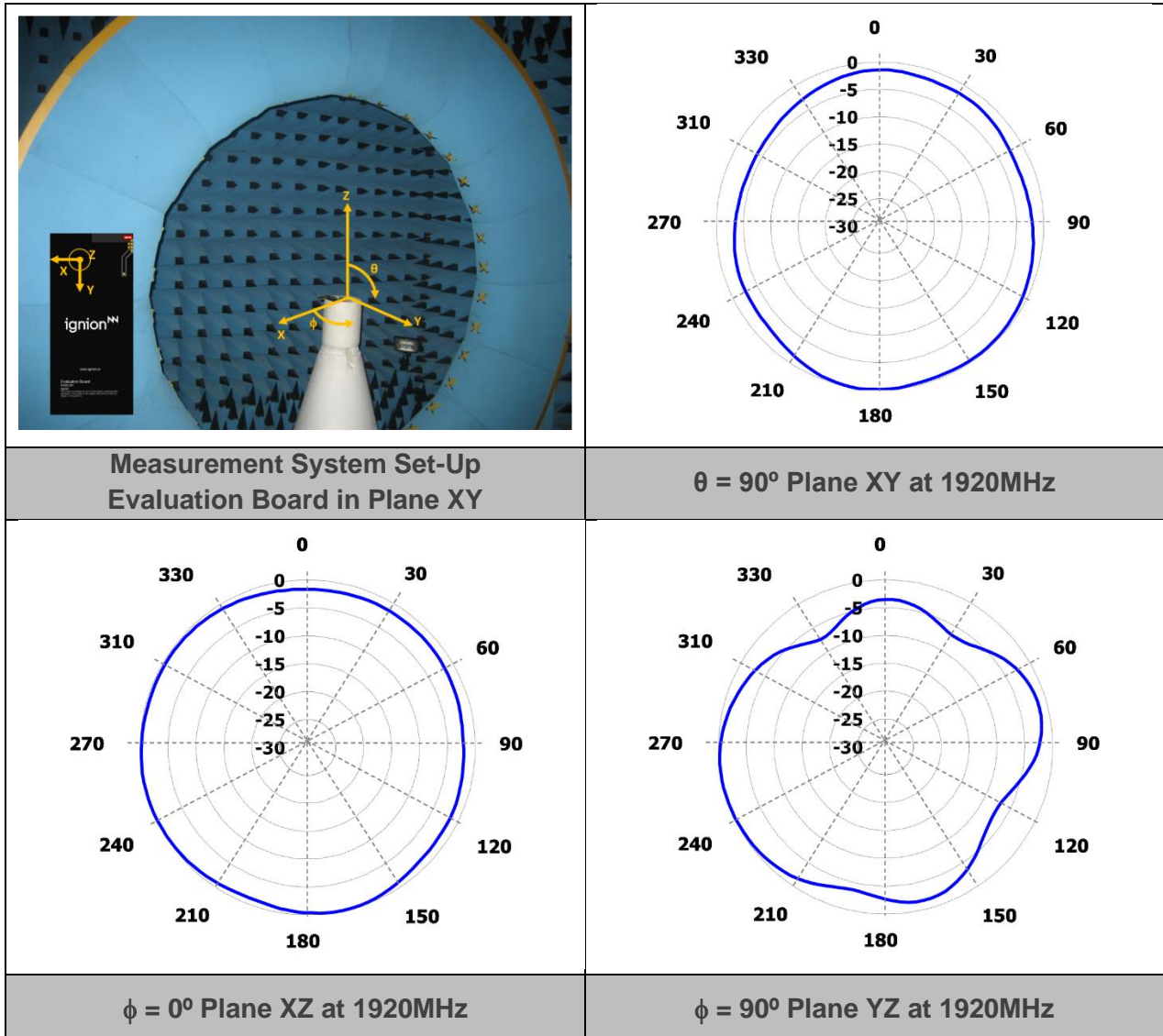

Gain	Peak Gain	2.0dBi
	Average Gain across the band	1.3dBi
	Gain Range across the band (min, max)	0dBi <-> 2.0dBi
Efficiency	Peak Efficiency	84.6%
	Average Efficiency across the band	74.6%
	Efficiency Range across the band (min, max)	55.2 – 84.6%

Table 6 – Antenna Gain and Total Efficiency from the evaluation board (Figure 4) 2G/3G-USA band (1850 – 2170 MHz). Measures made in the Satimo STARGATE 32 anechoic chamber

ONE mXTEND for 5G

The ONE mXTEND™ can enable 2G, 3G, 4G and 5G easy cellular IoT worldwide connectivity. In this application the **5G** frequency band will be analyzed using the ONE mXTEND™. Using one of our evaluation boards, an example of a common ONE mXTEND™ placement will be seen. Finally, a matching network will be selected, allowing us to test, obtain, and analyze the VSWR, total efficiency, gain and radiation patterns.

QUICK REFERENCE GUIDE

Technical features	2500 MHz – 5000 MHz
Average Efficiency	> 65 %
Peak Gain	4.1
VSWR	< 5:1
Radiation Pattern	Omnidirectional
Polarization	Linear
Weight (approx.)	0.02 g.
Temperature	-40 to +125 °C
Impedance	50 Ω
Dimensions (L x W x H)	7.0 mm x 3.0 mm x 1.0 mm

Table 7 – Technical Features. Measures from the evaluation board (**Error! Reference source not found.**).

EVALUATION BOARD

This evaluation board (part number: EB_NN02-201-5G) is made with a coplanar grounded transmission line (trace on the PCB) to connect the ONE mXTEND[™] antenna booster with the SMA connector. The ONE mXTEND[™] provides operation in the frequency region from 2500 MHz to 5000 MHz, through a single input/output port.

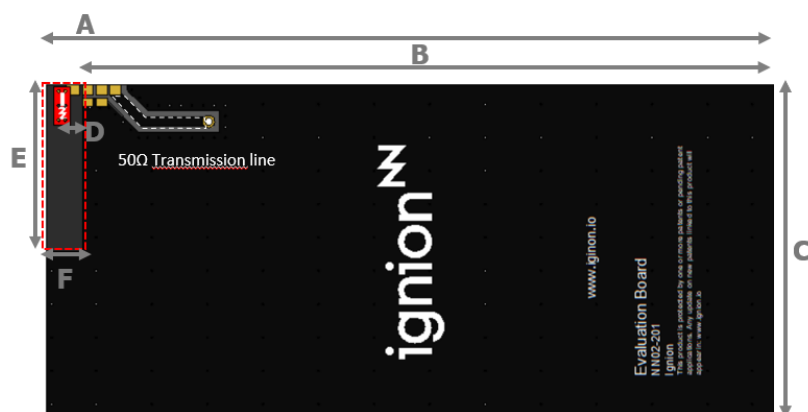

Measure	mm
A	131
B	124.5
C	60
D	2.5
E	30
F	6.5

Tolerance: ±0.2 mm

D: Distance between the ONE mXTEND[™] antenna booster and the ground plane.

Material: The evaluation boards are built on FR4 substrate. Thickness is 1 mm.

Clearance Area: 30 mm x 6.5 mm (ExF)

Figure 7 – EB_NN02-201-5G. Evaluation board providing operation at 5G bands (from 2500 MHz to 5000 MHz).

This product and its use are protected by at least one or more of the following [patents and patent applications](#) PAT. US 9,130,259 B2; US 16/731755; EP 18736916.0 and other domestic and international patents pending. Additional information about patents related to this product is available at www.ignion.io/virtual-antenna/.

MATCHING NETWORK

ONE mXTEND™ antenna booster needs a matching network to connect to your 5G receiver. This section describes a suitable matching network (**Error! Reference source not found.**) for ONE mXTEND™ and the resulting product specs when measured in the reference evaluation board (EB_NN02-201-5G) (**Error! Reference source not found.**). Please note that different devices with different form factors, ground planes, and nearby components may need a different matching network.

ONE mXTEND™ antenna booster is a versatile product, bringing a broadband solution able to cover the 5G frequency bands n77, n78, n79 and n90. This solution can easily be changed to operate in a more specific 5G band, optimizing the performance of the antenna booster. If you need assistance to design your matching network, please contact support@ignion.io, or try our free-of-charge¹ **NN Wireless Fast-Track** design service, you will get your chip antenna design including a custom matching network for your device in 24h³. Other information related to NN's range of R&D services is available at: <https://www.ignion.io/rdservices/>

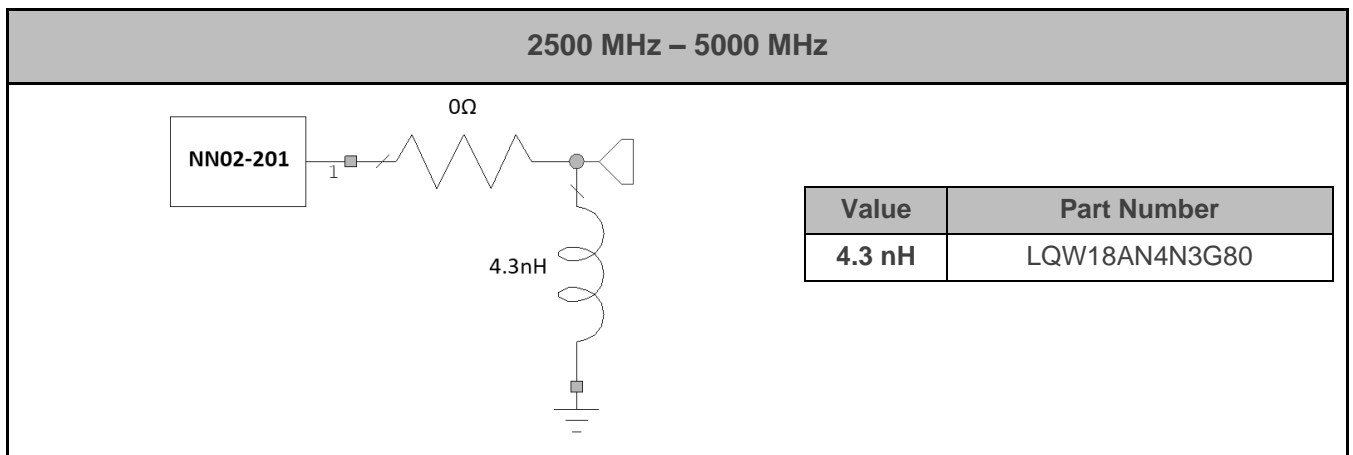

Figure 8 – Matching network implemented in the evaluation board (Error! Reference source not found.**).**

To ensure optimal results, the use of high-quality factor (Q) and tight tolerance components is highly recommended (e.g. Murata components with part numbers as in **Error! Reference source not found.**). The antenna performance is always conditioned by its operating environment so that different devices with different printed circuit board sizes, components nearby the antenna, LCD's, batteries, covers, connectors, etc. affect the antenna performance. Accordingly, it is highly recommended placing pads compatible with 0402 and 0603 SMD components for a matching network as close as possible to the feeding point of the antenna element. Do it in the ground plane area, not in the clearance area. By tuning the matching network in your final design with your final surrounding components (batteries, displays, covers, etc.) you will be able to optimize the antenna performance without changing the antenna part.

³ See terms and conditions for a free NN Wireless Fast-Track service in 24h at: <https://www.ignion.io/fast-track-project/>

VSWR AND TOTAL EFFICIENCY

SWR (Voltage Standing Wave Ratio) and Total Efficiency versus Frequency (GHz).

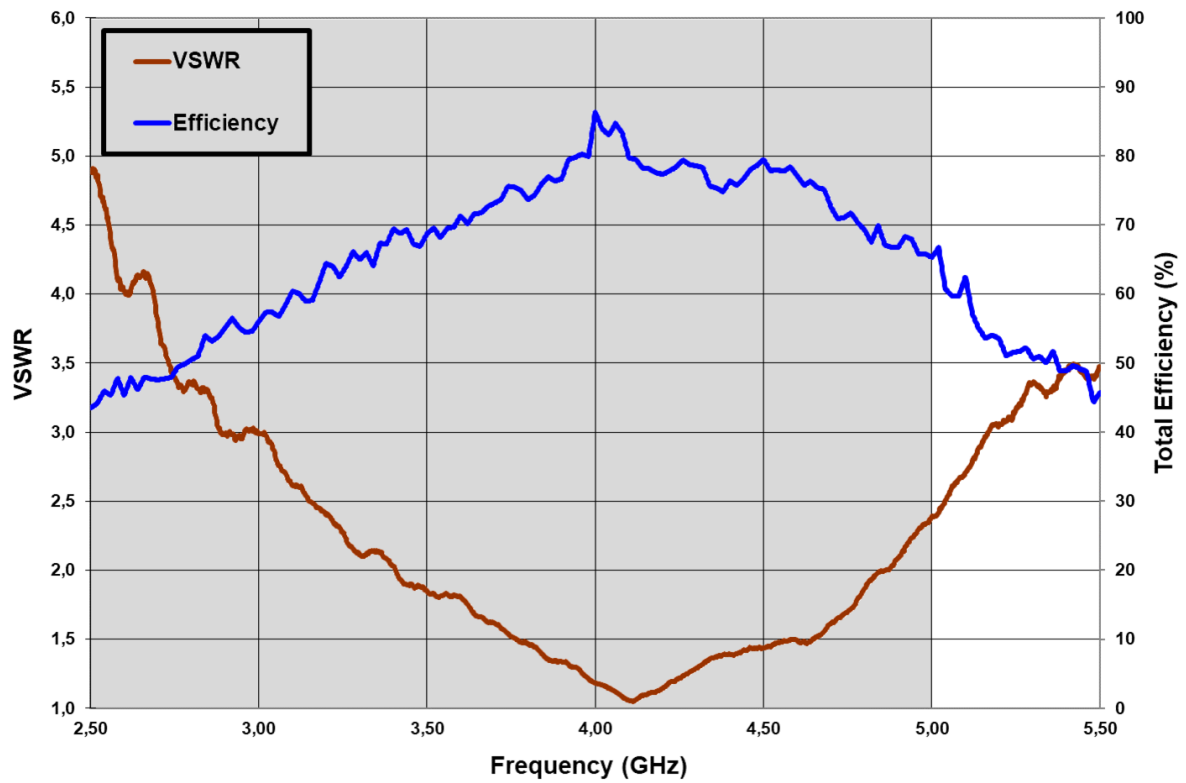

Figure 9 – VSWR and Total Efficiency at 5G bands (2500 MHz – 5000 MHz) (from the evaluation board) (Error! Reference source not found.).

RADIATION PATTERNS (2500 MHz – 5000 MHz), GAIN, AND EFFICIENCY

			
<p>Measurement System Set-Up Evaluation Board in Plane XY</p>		<p>$\theta = 90^\circ$ Plane XY at 4150MHz</p>	
			
<p>$\phi = 0^\circ$ Plane XZ at 4150MHz</p>		<p>$\phi = 90^\circ$ Plane YZ at 4150MHz</p>	
<p>Gain</p>	<p>Peak Gain</p>	<p>3.9dBi</p>	
	<p>Average Gain across the band</p>	<p>2.6dBi</p>	
	<p>Gain Range across the band (min, max)</p>	<p>-0.4dBi <-> 3.9dBi</p>	
<p>Efficiency</p>	<p>Peak Efficiency</p>	<p>86.3%</p>	
	<p>Average Efficiency across the band</p>	<p>67.7%</p>	
	<p>Efficiency Range across the band (min, max)</p>	<p>43.5 – 86.3%</p>	

Table 8 – Antenna Gain and Total Efficiency from the evaluation board (Error! Reference source not found.) 5G bands (2500 MHz – 5000 MHz). Measures made in the Satimo STARGATE 32 anechoic chamber.

ONE mXTEND for Wi-Fi 6E

The ONE mXTEND[™] antenna booster is a **standard antenna solution that supports all possible frequency coverage combinations of Wi-Fi 5, Wi-Fi 6 and Wi-Fi 6E**. In this application the new standard of Wi-Fi 6E covered by the ONE mXTEND[™] and how its performance adapts to three different evaluation board sizes (200 x 200 mm, 150 x 75 mm, 86 x 54 mm) is seen. Finally, two matching networks will be selected for various sizes, allowing us to test, obtain, and analyze the VSWR, total efficiency, gain and radiation patterns.

QUICK REFERENCE GUIDE (86 x 54 mm Evaluation Board)

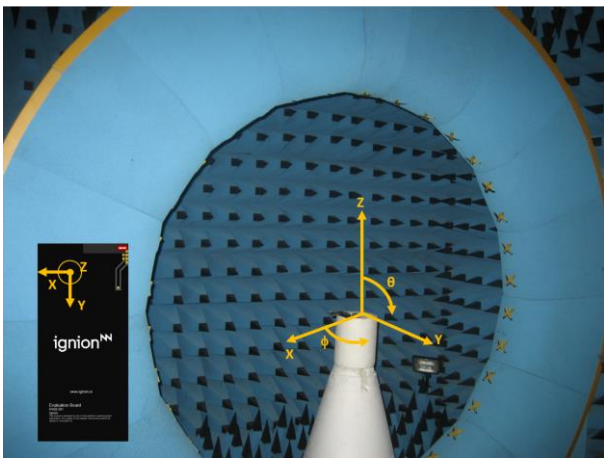
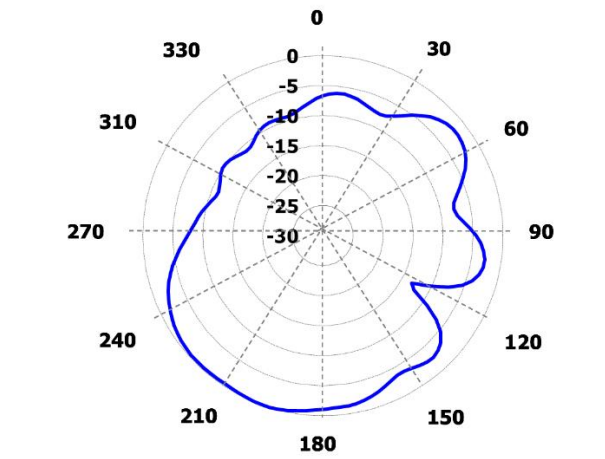
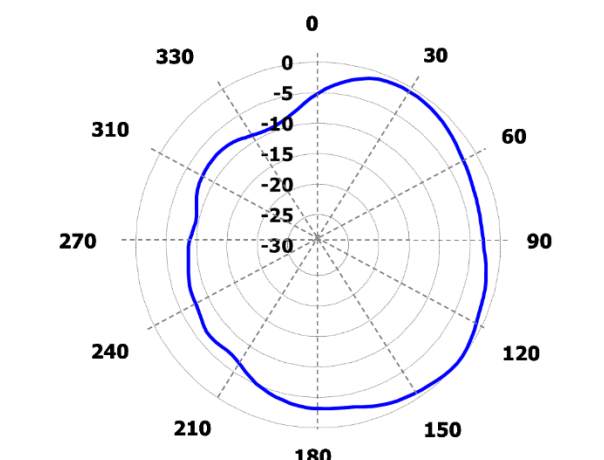
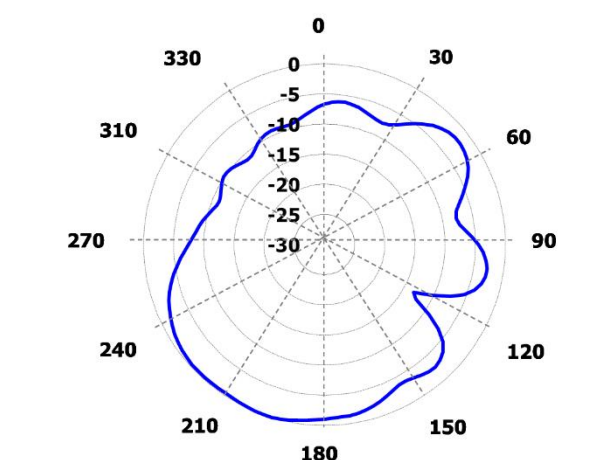
Technical features	2400 - 2500 MHz	5170 - 5835 MHz	5925 – 7125 MHz
Average Efficiency	> 80 %	> 85 %	> 85 %
Peak Gain	3.2 dBi	3.3 dBi	5.0 dBi
VSWR	< 2:1		
Radiation Pattern	Omnidirectional		
Polarization	Linear		
Weight (approx.)	0.02 g		
Temperature	-40 to +125 °C		
Impedance	50 Ω		
Dimensions (L x W x H)	7.0 mm x 3.0 mm x 1.0 mm		

Table 9 – Technical features. Measurements from one of the three Evaluation Board sizes analyzed. See **Error! Reference source not found.**

EVALUATION BOARDS

The performance of the ONE mXTEND[™] antenna booster operating in the Wi-Fi 6E frequency bands is measured in different EBs featured by different sizes. This is intended to illustrate on one hand, how the antenna performance varies according to the ground plane length of any printed circuit board (PCB), and on the other hand, how our ONE mXTEND[™] antenna booster can be easily adapted to the different scenarios by simply adjusting the matching network design. The antenna part remains the same and the operating frequencies can be easily tuned by only properly adjusting the matching network. The following results cover a wide scope of EB sizes (length and width), ranging from 200mm x 200mm down to 86mm x 54mm (Figure 10), representatives of routers, gateways, smartphones, and small tracker or IOT devices.

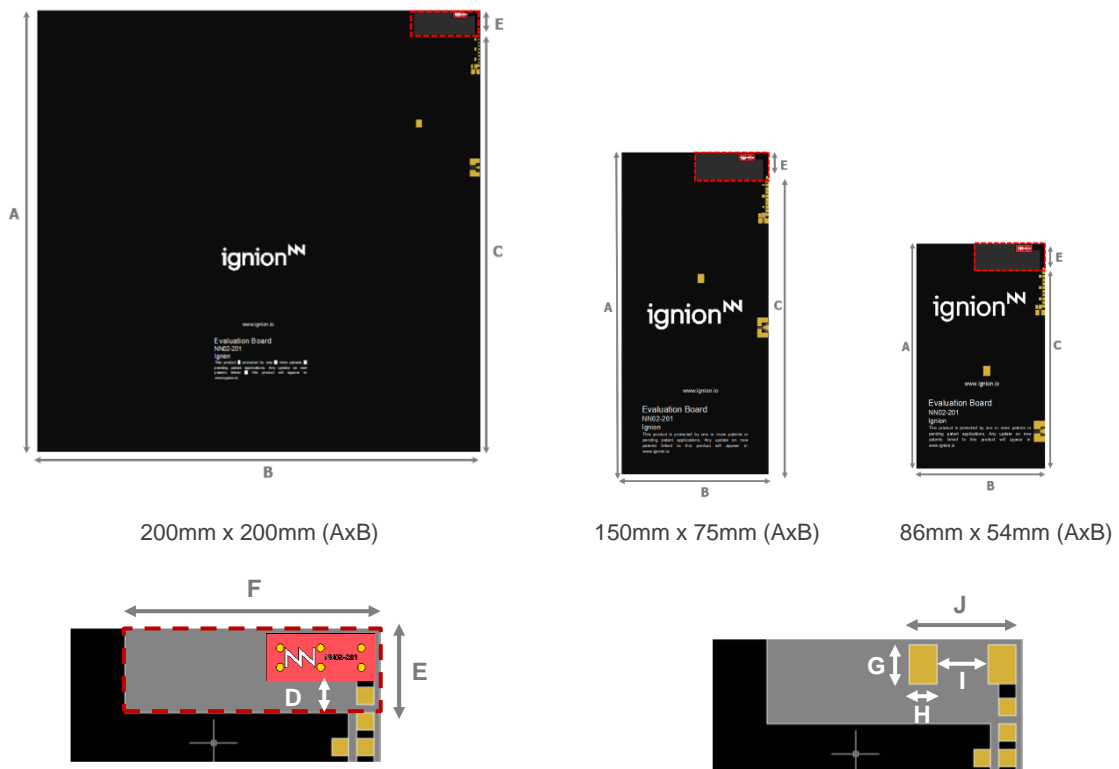

Measure	mm	Measure	mm
A	200 – 86	F	15
B	200 – 54	G	2.3
C	195 – 81	H	1.65
D	2.0	I	3.0
E	5.0	J	6.3

Tolerance: ±0.2 mm

D: Distance between the ONE mXTEND[™] antenna booster and the ground plane.

Material: The evaluation board is built on FR4 substrate. Thickness is 1 mm.

Clearance Area: 15 mm x 5.0 mm (FxEx) (indicated in dashed red line)

Figure 10 – Evaluation boards with different form factors and different ground plane lengths. Detailed image of the ONE mXTEND[™] antenna booster placed in the top right corner of the different sized EBs (left) and its footprint (right).

Please note that the ONE mXTEND™ is a versatile antenna solution that is able to cover other frequency ranges besides those covered in this document. If your device is to operate in any other band, please contact to support@ignion.io for assistance. We are here to help.

VSWR AND EFFICIENCY

This section explains the antenna performance in terms of VSWR (Voltage Standing Wave Ratio) and Total Efficiency results versus frequency (GHz) for the Wi-Fi 6E frequency bands.

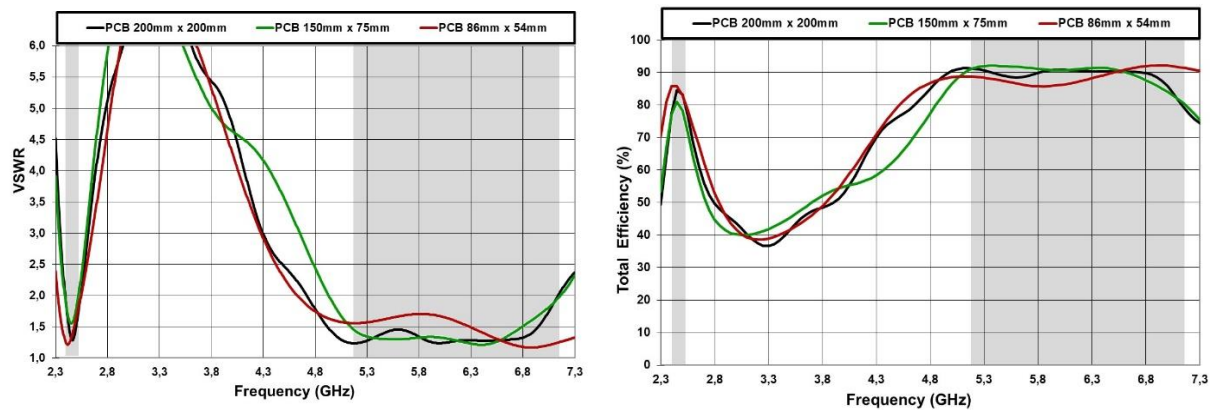

Figure 11 – VSWR and Total Efficiency for the 2.400 – 2.500 GHz frequency range and for the 5.170 – 7.125 GHz frequency range considering the different EB sizes (Figure 10).

B x C (mm)	2.400 – 2.500GHz				
	η_a 2400MHz	η_a 2500MHz	Min	Max	Av. η_a
200 x 200	77.6	83.3	77.6	84.6	81.8
150 x 75	77.2	78.3	77.2	81.8	78.9
86 x 54	85.8	83.0	83.0	85.9	84.9

Table 10 – Antenna efficiency comparison considering the different EB sizes for 2.400 – 2.500GHz frequency range (Figure 10).

B x C (mm)	5.170 – 5.835GHz					5.925 – 7.125GHz				
	η_a 5170MHz	η_a 5835MHz	Min	Max	Av. η_a	η_a 5925MHz	η_a 7125MHz	Min	Max	Av. η_a
200 x 200	91.3	90.3	88.5	91.3	89.7	90.6	79.3	79.3	90.9	89.0
150 x 75	90.7	91.0	90.7	92.1	91.6	90.9	80.5	80.5	91.5	88.7
86 x 54	88.8	85.8	85.8	88.8	87.3	85.8	91.5	85.8	92.2	89.6

Table 11 - Antenna efficiency comparison considering the different EB sizes for 5.170 - 5.835GHz and 5.925 – 7.125GHz frequency ranges (Figure 10).

ONE mXTEND[™] operates the required Wi-Fi 6E frequency spectrum with high efficiency values. Please note that its performance can be maintained high across different sized EBs by simply adjusting the matching network design.

MATCHING NETWORK

The ONE mXTEND[™] antenna booster needs a matching network to connect to your Wi-Fi 6E transceiver. This section describes the recommended matching network topologies and values (**Error! Reference source not found.**, **Figure** , **Table** and **Table**) for the different sized EBs (**Figure 10**).

Thanks to its versatility the ONE mXTEND[™] antenna booster can be easily tuned to cover Wi-Fi 6E spectrum in different sized platforms through just the proper adjustment of the matching network. The excellent tuning capabilities of the ONE mXTEND[™] makes it ideal to avoid unnecessary product redesigns each time your product specifications and operating frequencies vary. It allows you to easily adapt your design to different applications, market segments, and devices through just the proper design of the matching network by maintaining the same antenna part.

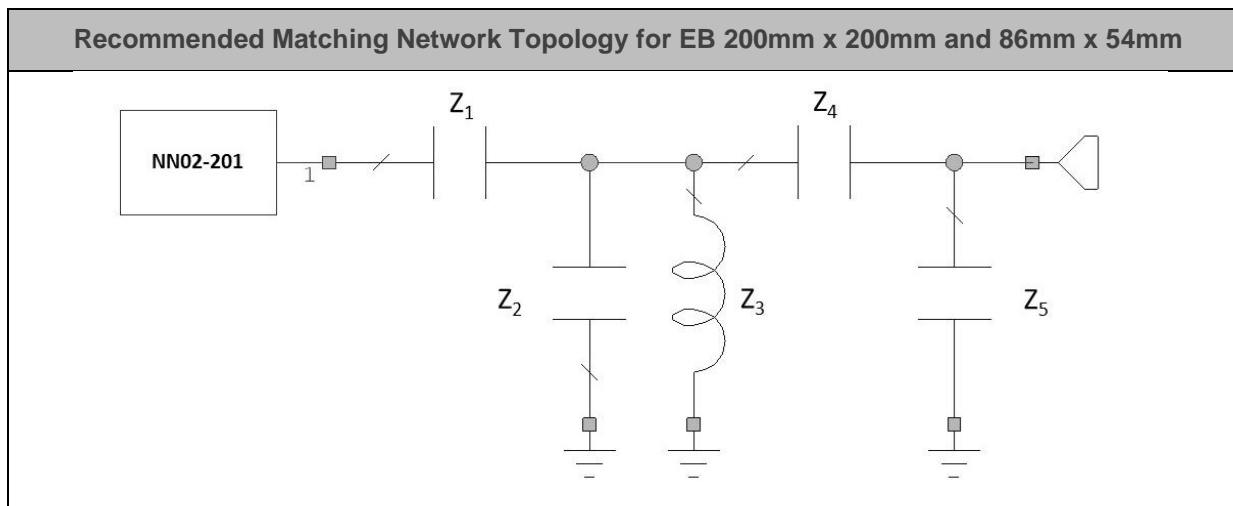

Figure 12 – Topology of the matching network mounted at the solutions: 200mm x 200mm and 86mm x 54mm (Figure 10)

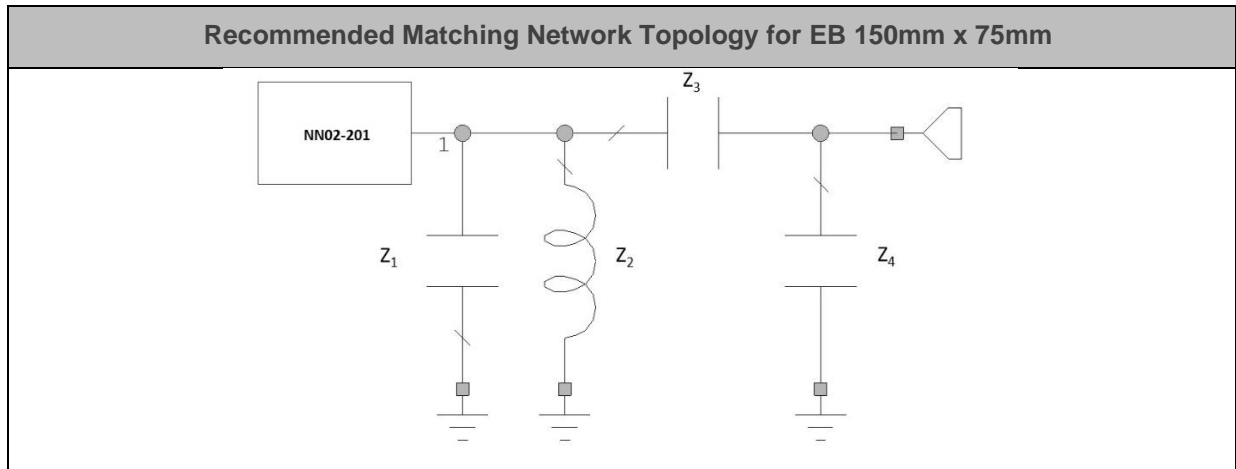

Figure 13 - Topology of the matching network mounted at the solution: 150mm x 75mm (Figure 10).

The matching network topology (**Error! Reference source not found.**) remains equal for the cases 200mm x 200mm and 86mm x 54mm and just the values of the matching network components must be adjusted to tune the antenna performance to the required operating frequency bands. A different matching network topology is recommended for the 150mm x 75mm case (**Figure**). The recommended matching network component values for operating the Wi-Fi 6E standards ranging from 2400 – 2500MHz and 5170 – 7125 MHz are shown in Table and Table .

A x B (mm)	Z ₁	Z ₂	Z ₃	Z ₄	Z ₅
200mm x 200mm	4.0pF	0.3pF	2.3nH	0.4pF	0.3pF
150mm x 75mm	0.3pF	2.6nH	0.4pF	0.3pF	-
86mm x 54mm	2.4pF	0.2pF	2.7nH	0.4pF	0.2pF

Table 12 - Values of the matching network components for the different EB sizes (Figure 10).

Value		Part Number
Z1	4.0pF	GJM1555C1H4R0WB01
	0.3pF	GJM1555C1HR30WB01
	2.4pF	GJM1555C1H2R4WB01
Z2	0.3pF	GJM1555C1HR30WB01
	2.6nH	LQW15AN2N6G80
	0.2pF	GJM1555C1HR20WB01
Z3	2.3nH	LQW15AN2N3G80
	0.4pF	GJM1555C1HR40WB01
	2.7nH	LQW15AN2N7G80
Z4	0.4pF	GJM1555C1HR40WB01
	0.3pF	GJM1555C1HR30WB01
	0.4pF	GJM1555C1HR40WB01
Z5	0.3pF	GJM1555C1HR30WB01
	0.2pF	GJM1555C1HR20WB01

Table 13 - Values and part numbers of the components used for the matching networks for the different EB sizes.

The antenna performance is always conditioned by its operating environment. Different devices with different printed circuit board sizes, components nearby the antenna, LCD's, batteries, covers, connectors, etc. may need a different matching network. Accordingly, it is highly recommended placing pads compatible with 0402 and 0603 SMD components for a matching network as close as possible to the feeding point of the antenna element in the ground plane area, not in the clearance area. This provides a degree of freedom to tune the ONE mXTEND™ antenna booster once the design is finished and takes into account all elements of the system (batteries, displays, covers, etc.). To ensure optimal results, the use of high-quality factor (Q) and tight tolerance components is highly recommended (e.g. Murata components (**Table 11** and **Table 12**)).

If you need assistance to design your matching network, please contact support@ignion.io, or if you are designing a **different device size** or a **different frequency band**, we can assist you in less than 24 hours. Please, try our free-of-charge¹ **NN Wireless Fast-Track** design service (<https://ignion.io/fast-track-project/>), you will get your complete design report including a custom matching network for your device in 24h⁴. Additional information related to NN's range of R&D services is available at: <https://www.ignion.io/rdservices/>

⁴ See terms and conditions for a free NN Wireless Fast-Track service in 24h at: <https://www.ignion.io/fast-track-project/>

RADIATION PATTERNS (2.400 - 2.500 GHz), GAIN, AND EFFICIENCY

This section describes the different radiation patterns, gain and efficiency of the ONE mXTEND[™] antenna booster depending on the different evaluation board sizes.

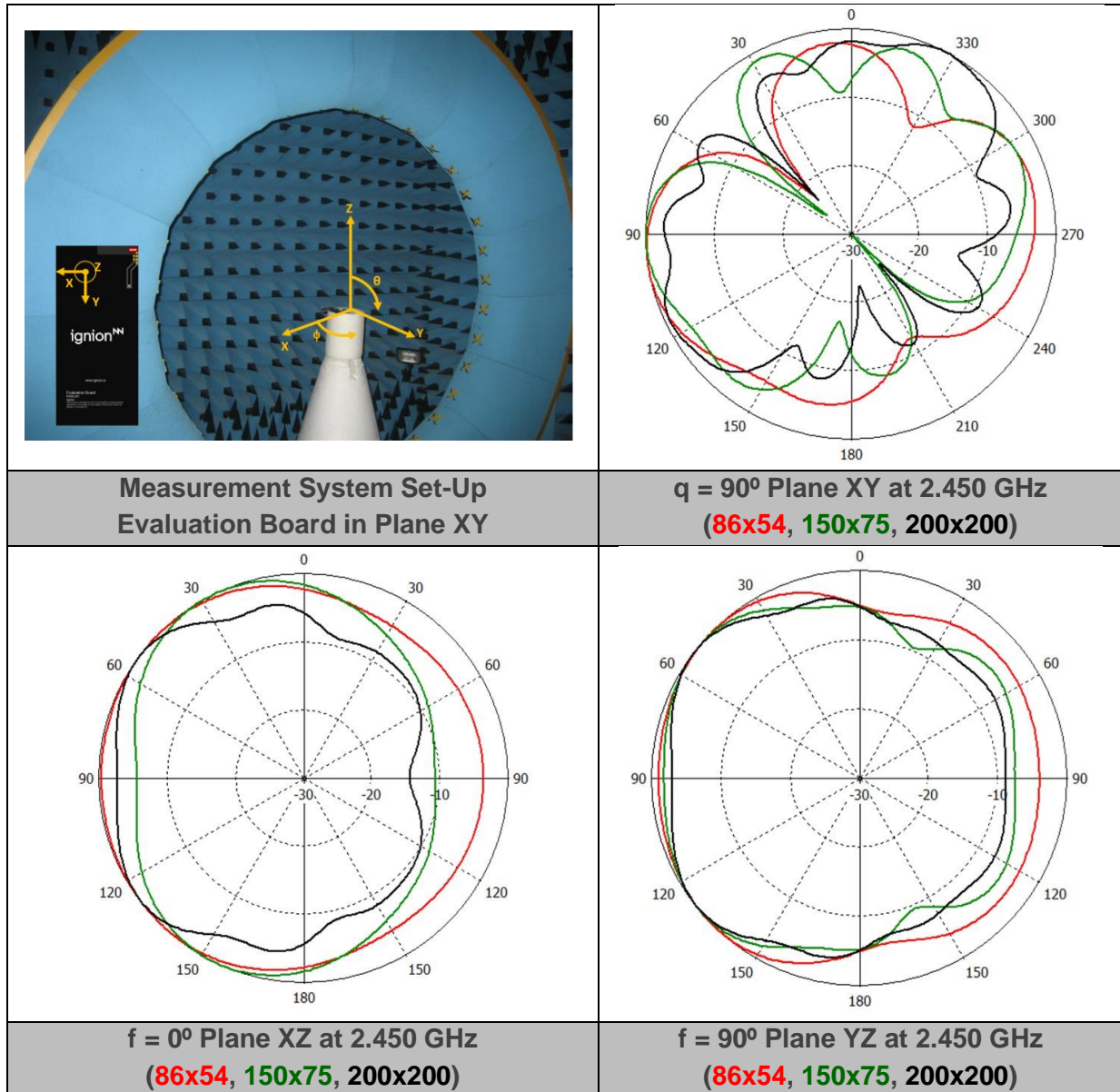

LFR Wi-Fi 6E 2.400- 2.500GHz	Gain	Peak Gain <small>(86x54)</small>	3.2 dBi
		Average Gain across the band <small>(86x54)</small>	3.2 dBi
		Gain Range across the band (min, max) <small>(86x54)</small>	3.1 <--> 3.2 dBi
	Efficiency	Peak Efficiency <small>(86x54)</small>	85.9 %
		Average Efficiency across the band <small>(86x54)</small>	84.9 %
		Efficiency Range across the band (min, max) <small>(86x54)</small>	83.0 – 85.9 %

Table 14 - Antenna gain and total efficiency from the Evaluation Board of 86mm x 54mm (**Error! Reference source not found.**) for 2.400GHz – 2.500GHz with the matching network of **Error! Reference source not found.**. Simulated results obtained with CST.

LFR Wi-Fi 6E 2.400- 2.500GHz	Gain	Peak Gain <small>(150x75)</small>	4.1 dBi
		Average Gain across the band <small>(150x75)</small>	4.0 dBi
		Gain Range across the band (min, max) <small>(150x75)</small>	3.8 <--> 4.1 dBi
	Efficiency	Peak Efficiency <small>(150x75)</small>	81.1 %
		Average Efficiency across the band <small>(150x75)</small>	78.9 %
		Efficiency Range across the band (min, max) <small>(150x75)</small>	77.2 – 81.1 %

Table 15 - Antenna gain and total efficiency from the Evaluation Board of 150mm x 75mm (Figure) for 2.400GHz – 2.500GHz with the matching network of **Figure** Simulated results obtained with CST.

LFR Wi-Fi 6E 2.400- 2.500GHz	Gain	Peak Gain <small>(200x200)</small>	5.2 dBi
		Average Gain across the band <small>(200x200)</small>	5.1 dBi
		Gain Range across the band (min, max) <small>(200x200)</small>	4.8 <--> 5.2 dBi
	Efficiency	Peak Efficiency <small>(200x200)</small>	84.6 %
		Average Efficiency across the band <small>(200x200)</small>	81.8 %
		Efficiency Range across the band (min, max) <small>(200x200)</small>	77.6 – 84.6 %

Table 16 – Antenna gain and total efficiency from the Evaluation Board of 200mm x 200mm (**Error! Reference source not found.**) for 2.400GHz – 2.500GHz with the matching network of **Error! Reference source not found.**. Simulated results obtained with CST.

RADIATION PATTERNS (5.170 - 5.835 GHz), GAIN, AND EFFICIENCY

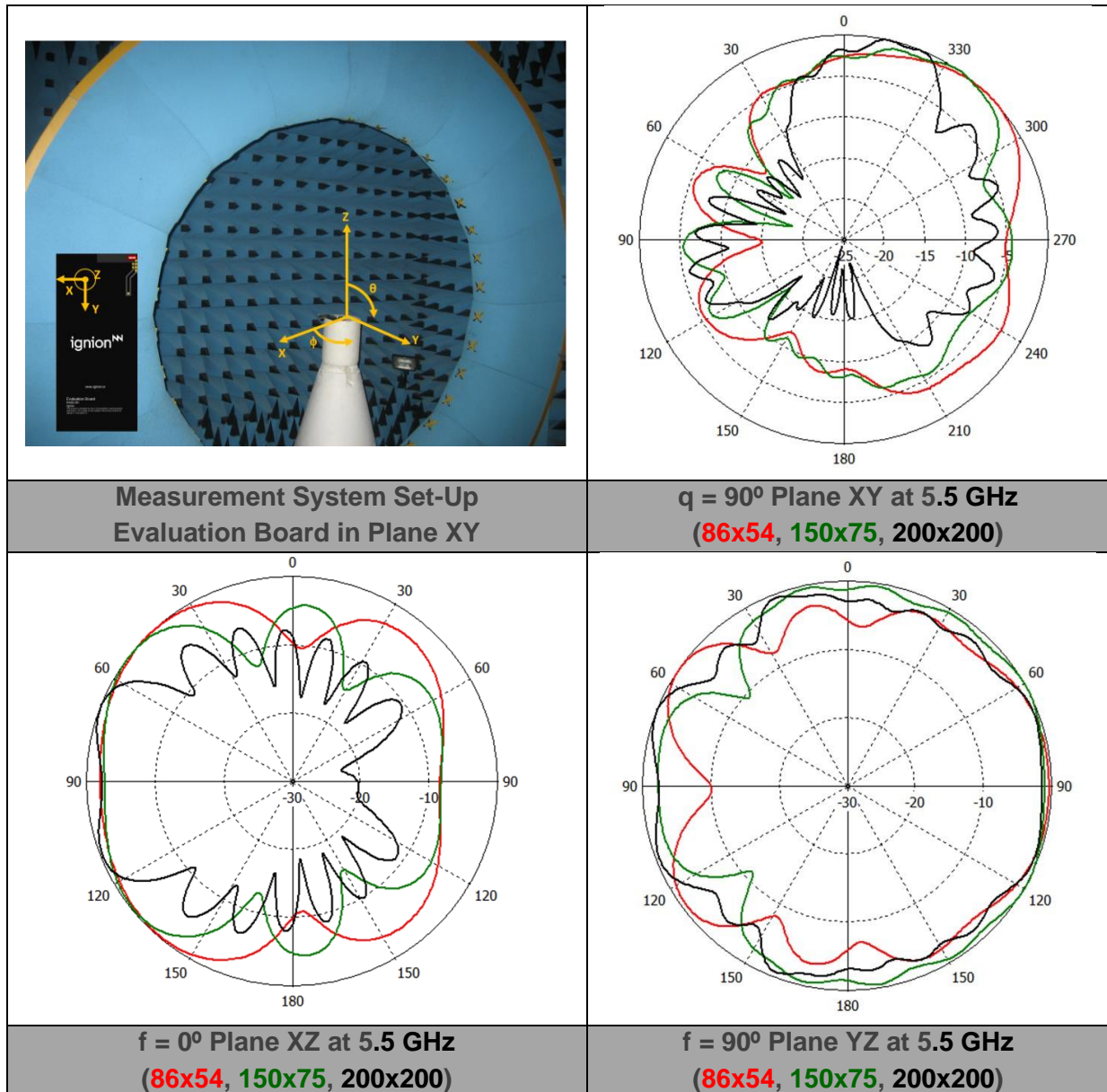

HFR Wi-Fi 6E 5.170- 5.835GHz	Gain	Peak Gain <small>(86x54)</small>	3.3
		Average Gain across the band <small>(86x54)</small>	3.1
		Gain Range across the band (min, max) <small>(86x54)</small>	2.9 – 3.3
	Efficiency	Peak Efficiency <small>(86x54)</small>	88.8
		Average Efficiency across the band <small>(86x54)</small>	87.3
		Efficiency Range across the band (min, max) <small>(86x54)</small>	85.8 – 88.8

Table 17 - Antenna gain and total efficiency from the Evaluation Board of 86mm x 54mm (**Error! Reference source not found.**) for 5.170GHz – 5.835GHz with the matching network of **Error! Reference source not found.** Simulated results obtained with CST.

HFR Wi-Fi 6E 5.170- 5.835GHz	Gain	Peak Gain <small>(150x75)</small>	5.1
		Average Gain across the band <small>(150x75)</small>	5.0
		Gain Range across the band (min, max) <small>(150x75)</small>	4.7 – 5.1
	Efficiency	Peak Efficiency <small>(150x75)</small>	92.1
		Average Efficiency across the band <small>(150x75)</small>	91.6
		Efficiency Range across the band (min, max) <small>(150x75)</small>	90.7 – 92.1

Table 18 - Antenna gain and total efficiency from the Evaluation Board of 150mm x75mm (Figure for 5.170GHz – 5.835GHz with the matching network of Figure . Simulated results obtained with CST.

HFR Wi-Fi 6E 5.170- 5.835GHz	Gain	Peak Gain <small>(150x75)</small>	7.8
		Average Gain across the band <small>(150x75)</small>	7.5
		Gain Range across the band (min, max) <small>(150x75)</small>	7.3 – 7.8
	Efficiency	Peak Efficiency <small>(150x75)</small>	91.3
		Average Efficiency across the band <small>(150x75)</small>	89.7
		Efficiency Range across the band (min, max) <small>(150x75)</small>	88.5 – 91.3

Table 19 - Antenna gain and total efficiency from the Evaluation Board of 200mm x200mm (**Error! Reference source not found.**) for 5.170GHz – 5.835GHz with the matching network of **Error! Reference source not found.** Simulated results obtained with CST.

RADIATION PATTERNS (5.925 - 7.125 GHz), GAIN, AND EFFICIENCY

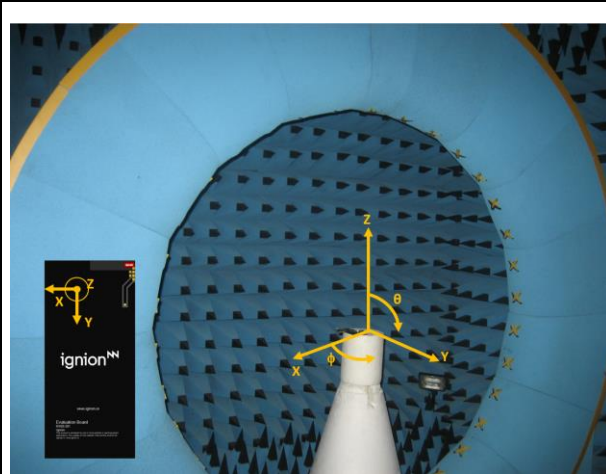

Measurement System Set-Up
Evaluation Board in Plane XY

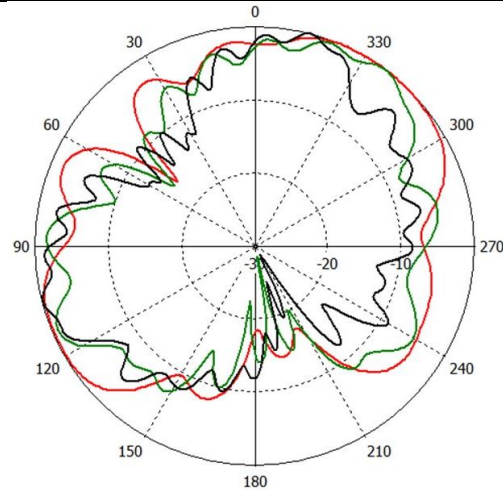

$q = 90^\circ$ Plane XY at 6.5 GHz
(86x54, 150x75, 200x200)

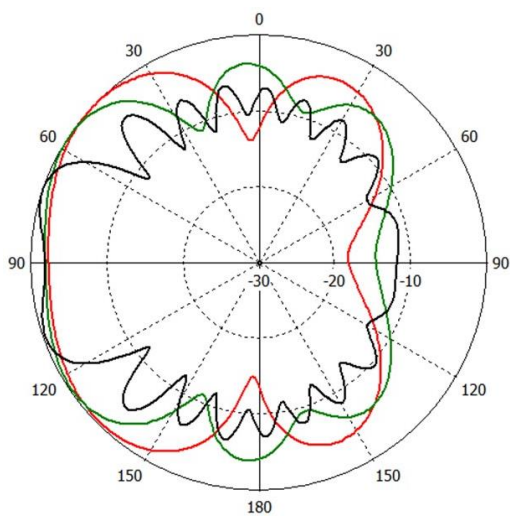

$f = 0^\circ$ Plane XZ at 6.5 GHz
(86x54, 150x75, 200x200)

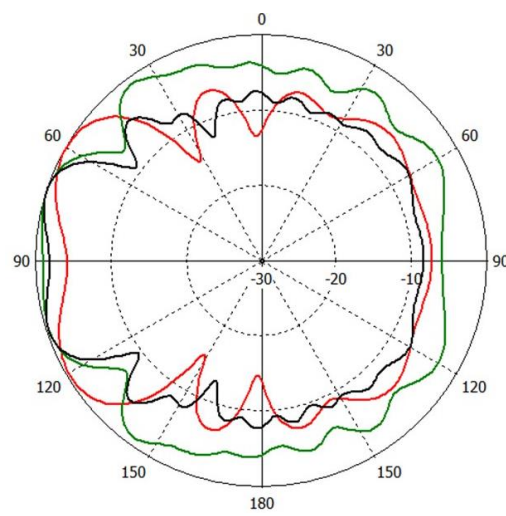

$f = 90^\circ$ Plane YZ at 6.5 GHz
(86x54, 150x75, 200x200)

HFR Wi-Fi 6E 5.925- 7.125GHz	Gain	Peak Gain <small>(86x54)</small>	5.0
		Average Gain across the band <small>(86x54)</small>	4.3
		Gain Range across the band (min, max) <small>(86x54)</small>	2.9 – 5.0
	Efficiency	Peak Efficiency <small>(86x54)</small>	92.2
		Average Efficiency across the band <small>(86x54)</small>	89.6
		Efficiency Range across the band (min, max) <small>(86x54)</small>	85.8 – 92.2

Table 20 - Antenna gain and total efficiency from the Evaluation Board of 86mm x 54mm (**Error! Reference source not found.**) for 5.925GHz – 7.125GHz with the matching network of **Error! Reference source not found.**. Simulated results obtained with CST.

HFR Wi-Fi 6E 5.925- 7.125GHz	Gain	Peak Gain <small>(150x75)</small>	4.8
		Average Gain across the band <small>(150x75)</small>	4.5
		Gain Range across the band (min, max) <small>(150x75)</small>	4.2 – 4.8
	Efficiency	Peak Efficiency <small>(150x75)</small>	91.5
		Average Efficiency across the band <small>(150x75)</small>	88.7
		Efficiency Range across the band (min, max) <small>(150x75)</small>	80.5 – 91.5

Table 21 - Antenna gain and total efficiency from the Evaluation Board of 150mm x 75mm (Figure 13) for 5.925GHz – 7.125GHz with the matching network of Figure. Simulated results obtained with CST.

HFR Wi-Fi 6E 5.925- 7.125GHz	Gain	Peak Gain <small>(200x200)</small>	7.3
		Average Gain across the band <small>(200x200)</small>	6.7
		Gain Range across the band (min, max) <small>(200x200)</small>	6.5 – 7.3
	Efficiency	Peak Efficiency <small>(200x200)</small>	90.9
		Average Efficiency across the band <small>(200x200)</small>	89.0
		Efficiency Range across the band (min, max) <small>(200x200)</small>	79.3 – 90.9

Table 22 - Antenna gain and total efficiency from the Evaluation Board of 200mm x 200mm (Figure 10) for 5.925GHz – 7.125GHz with the matching network of Figure. Simulated results obtained with CST.

Mechanical Specifications

DIMENSIONS, TOLERANCES, AND RoHS

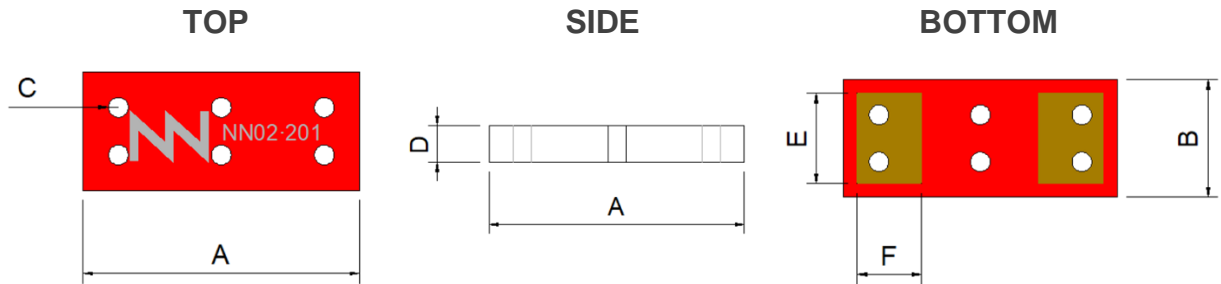

Dimension	mm	Dimension	mm
A	7.0	B	3.0
C	0.5	D	1.0
E	2.3	F	1.65

Figure 14 – ONE mXTEND[™] antenna booster dimensions and tolerances.

The ONE mXTEND[™] antenna booster NN02-201 is compliant with the restriction of the use of hazardous substances (RoHS). For more information, please contact info@ignion.io.

COLOR RANGE FOR THE INK

Next figure shows the range of the colors in the ONE mXTEND[™] antenna booster:

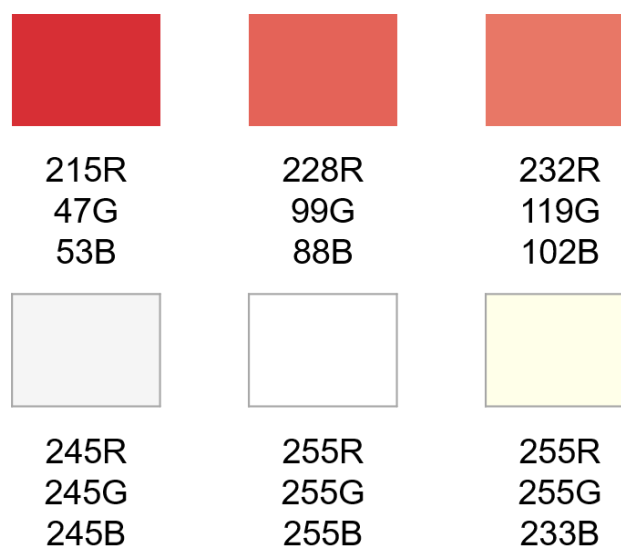

Acceptable color range

RECOMMENDED FOOTPRINT FOR THE NN02-201

See below the recommended footprint dimensions for the ONE mXTEND[™] antenna booster NN02-201.

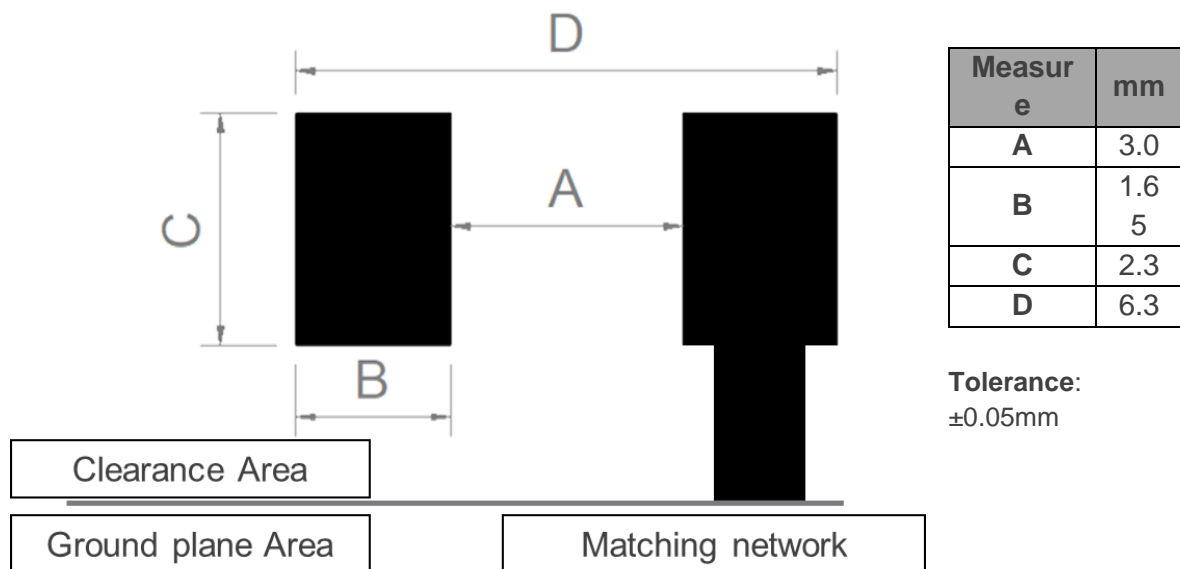

Figure 15 – Footprint dimensions for the ONE mXTEND[™] (NN02-201) antenna booster.

For additional support in the integration process, please contact support@ignion.io

ASSEMBLY AND MANUFACTURING

Error! Reference source not found. shows the back and front views of the ONE mXTEND[™] antenna booster (NN02-201).

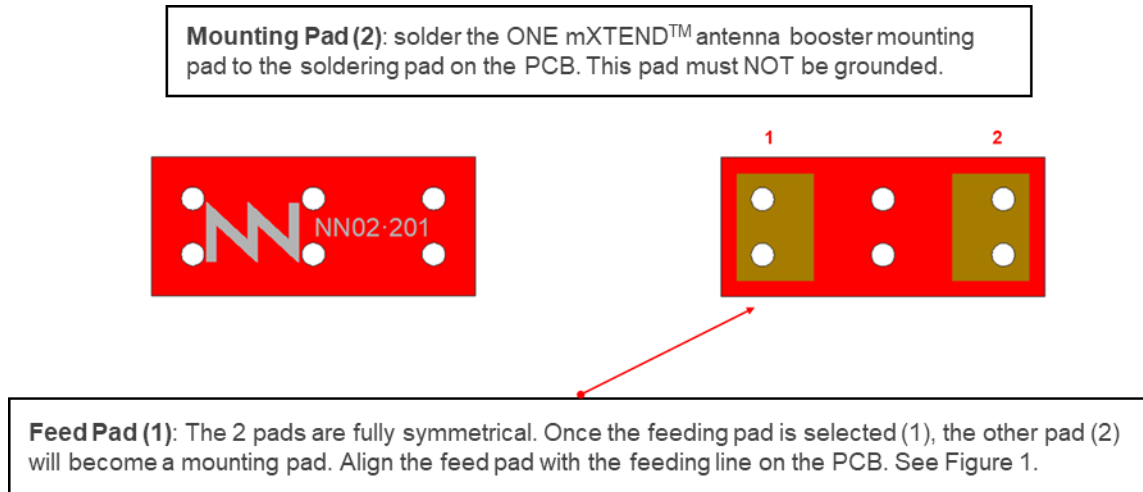

Figure 16 – Pads of the ONE mXTEND[™] antenna booster NN01-201.

As a surface mount device (SMD), the ONE mXTEND[™] antenna booster is compatible with industry standard soldering processes. The basic assembly procedure for the ONE mXTEND[™] antenna booster is as follows:

1. Apply a solder paste on the pads of the PCB. Place the ONE mXTEND[™] antenna booster on the board.
2. Perform a reflow process according to the temperature profile detailed in **Error! Reference source not found.**, **Error! Reference source not found.**
3. After soldering the ONE mXTEND[™] antenna booster to the circuit board, perform a cleaning process to remove any residual flux. Ignion recommends conducting a visual inspection after the cleaning process to verify that all reflux has been removed.

The drawing below shows the soldering details obtained after a correct assembly process:

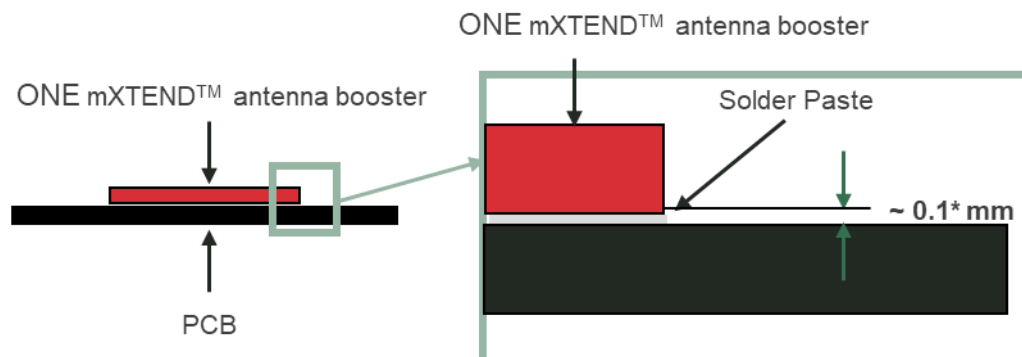

Figure 17 – Soldering Details.

NOTE(*): Solder paste thickness after the assembly process will depend on the thickness of the soldering stencil mask. A stencil thickness equal or larger than 127 microns (5 mils) is required.

The ONE mXTEND™ antenna booster (NN02-201) can be assembled following the Pb-free assembly process. According to the Standard **IPC/JEDEC J-STD-020C**, the temperature profile suggested is as follows:

Phase	Profile features	Pb-Free assembly (SnAgCu)
RAMP-UP	Avg. Ramp-up Rate (T _{smax} to T _p)	3 °C / second (max.)
PREHEAT	- Temperature Min (T _{smin}) - Temperature Max (T _{smax}) - Time (t _{smin} to t _{smax})	150 °C 200 °C 60-180 seconds
REFLOW	- Temperature (T _L) - Total Time above T _L (t _L)	217 °C 60-150 seconds
PEAK	- Temperature (T _p) - Time (t _p)	260 °C 20-40 seconds
RAMP-DOWN	Rate	6 °C/second max
Time from 25 °C to Peak Temperature		8 minutes max

Table 23 – Recommended soldering temperatures.

Next graphic shows temperature profile (grey zone) for the ONE mXTEND™ antenna booster assembly process reflow ovens.

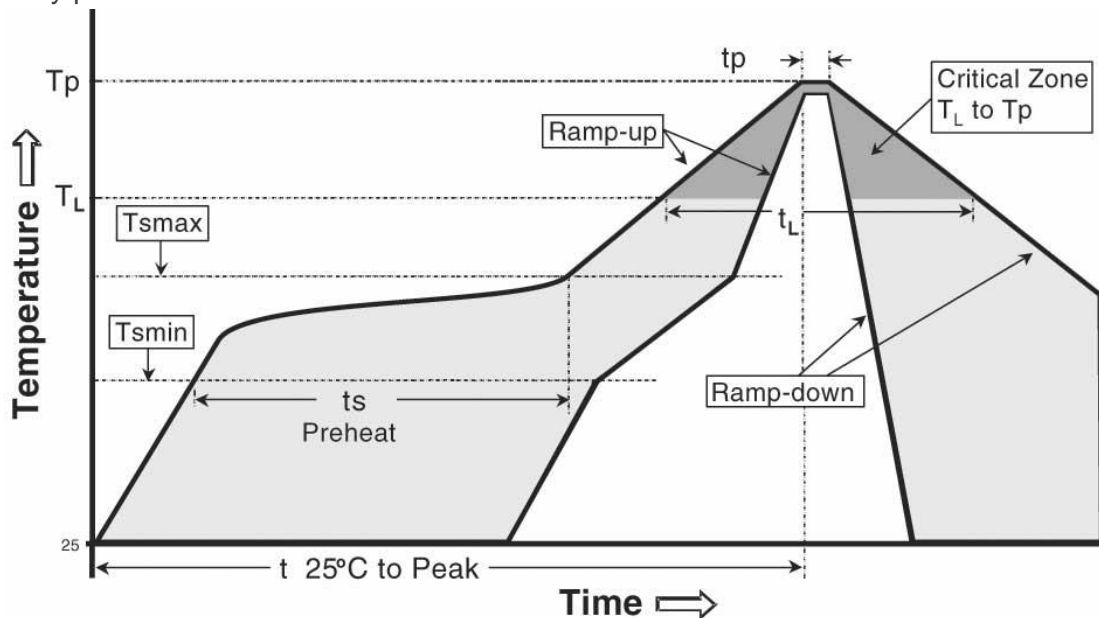

Figure 18 – Temperature profile.

PACKAGING

The ONE mXTEND™ antenna booster NN02-201 is delivered in tape and reel packaging.

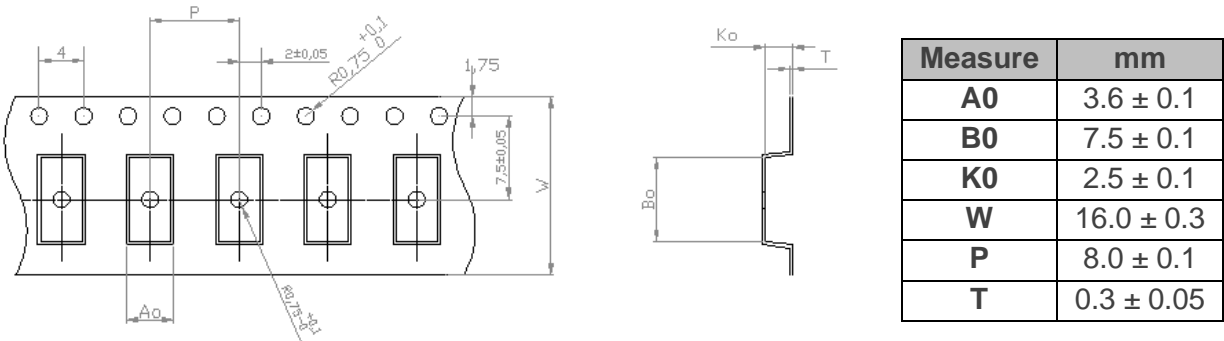

Figure 19 – Tape dimensions and tolerances.

REEL DIMENSIONS

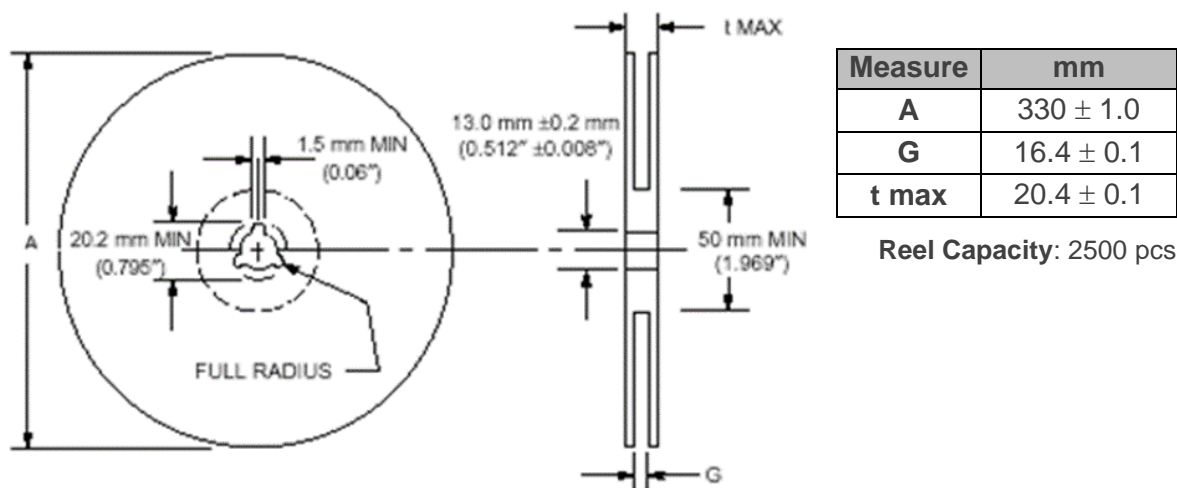

Figure 20 – Reel dimensions and capacity.

Ignion products and solutions are protected by [Ignion patents](#).

All information contained within this document is property of Ignion and is subject to change without prior notice. Information is provided “as is” and without warranties. It is prohibited to copy or reproduce this information without prior approval.

Ignion is an ISO 9001:2015 certified company. All our antennas are lead-free and RoHS compliant.

ISO 9001: 2015 Certified





Your innovation.
Accelerated.

Contact:

support@ignion.io

+34 935 660 710

Barcelona

Av. Alcalde Barnils, 64-68 Modul C, 3a pl.
Sant Cugat del Vallés
08174 Barcelona
Spain

Shanghai

Shanghai Bund Centre
18/F Bund Centre, 222 Yan'an Road East,
Huangpu District
Shanghai, 200002
China

New Dehli

New Delhi, Red Fort Capital Parsvnath Towers
Bhai Veer Singh Marg, Gole Market,
New Delhi, 110001
India

Tampa

8875 Hidden River Parkway
Suite 300
Tampa, FL 33637
USA