

ignion[™]

Your innovation.
Accelerated.

Triband chip antenna paired with Semtech's Lora Edge[™]

APPLICATION NOTE
TRIO mXTEND[™] (NN03-310)



TRIO MXTEND[™] PAIRED WITH SEMTECH'S LoRa Edge[™] (LR1110) TO PROVIDE MOBILE, GNSS & BLUETOOTH IN ONE DEVICE

- **Antenna Component:** TRIO mXTEND[™] NN03-310
- **Dimensions:** 30.0 mm x 3.0 mm x 1.0 mm
- **Frequency regions:** 863-928 MHz, 1561-1606 MHz & 2400-2500 MHz



Semtech's LoRa Edge[™] RF LoRa[®] Transceiver integrated with the TRIO mXTEND[™] provides tri-band asset location tracking

The TRIO mXTEND[™] chip antenna is the only solution in the market capable of enabling **three different radios (LoRa[®], multiband GNSS, and Wi-Fi/Bluetooth)** simultaneously through a single antenna component. Thanks to its modular, multiband and multiport configuration this chip antenna works in multiple frequency regions and makes it an ideal use in combination with the LoRa Edge[™] LR1110 from Semtech.

Semtech's LoRa Edge[™] provides an **ultra-low power** platform and integrates a long range LoRa[®] transceiver, multi-constellation scanner and passive Wi-Fi AP MAC address scanner. By using their Cloud-based solver and assistance service, (LoRa Cloud[™]) they can provide tracking capabilities with significantly reduced power consumption.

TRIO mXTEND[™] tri-band functionality, paired with Semtech's ultra-low power makes your **ASSET TRACKING device simpler, more efficient and more compact while still managing to reduce its time to market.** TRIO mXTEND[™] is presented in an **ultra slim, off the shelf component of only 1.0 mm height**, this gives the designer freedom to integrate it in about all wireless platforms.

The Semtech[®] and LoRa[®] Logos are a trademark of Semtech Corporation or its subsidiaries

TABLE OF CONTENTS

1.	TRIO mXTEND™ ANTENNA COMPONENT & SEMTECH LR110	4
2.	REFERENCE DESIGN	5
2.1.	MATCHING NETWORK	7
2.2.	VSWR AND EFFICIENCY	10
2.3.	TRANSMISSION COEFFICIENT	11
2.4.	RECOMMENDED ANTENNA FOOTPRINT FOR NN03-310	11
2.5.	RADIATION PATTERNS (LoRa), GAIN, AND EFFICIENCY	12
2.6.	RADIATION PATTERNS (GNSS), GAIN, AND EFFICIENCY	13
2.7.	RADIATION PATTERNS (Wi-Fi 2.4GHz), GAIN, AND EFFICIENCY	14
3.	PERFORMANCE IN DIFFERENT PCB SIZES	15
4.	PERFORMANCE IN DIFFERENT ENVIRONMENTS	16
4.1.	VSWR AND TOTAL EFFICIENCY	17
4.2.	CONCRETE	18
4.3.	WOOD	19
4.4.	METAL	20
4.5.	BODY PHANTOM	22
5.	DESIGN RECOMMENDATIONS	23
6.	CONCLUSIONS	24

1. TRIO mXTEND[™] ANTENNA COMPONENT & SEMTECH LR110

TRIO mXTEND[™] NN03-310



Dimensions: 30.0 mm x 3.0 mm x 1.0 mm

The **TRIO mXTEND[™] chip antenna component** (NN03-310) has been specifically designed for providing a high level of flexibility to operate any required frequency band inside any wireless device.

TRIO mXTEND[™] can be used in its **single port or multiport configuration**. Several radios can be allocated inside the same antenna component when used in its multiport configuration, thus allowing its operation in a great variety of communication standards through the same single antenna piece. This modular design **reduces the integration complexity considerably while saving cost, time and space**.

TRIO mXTEND[™] chip antenna component not only offers the versatility of being used in a single port or multiport configuration, but also offers the flexibility to be **tuned at the frequency regions of interest through just the proper adjustment of the matching network**. This characteristic provides an important benefit since it allows designers to easily adapt the antenna performance to the different device requirements, constraints, or environmental conditions without the need of changing the antenna component.

LoRa Edge[™] (LR1110)



Dimensions: 5.0 mm x 5.0 mm x 1.0 mm

LoRa Edge[™] is a long range, ultra-low power transceiver aimed to enhance **LoRa-based geolocation applications**. In addition to **Wi-Fi and GNSS geolocation** capabilities, it supports LoRa® and (G)FSK modulations, and is fully compatible with previous generations of LoRa radios. It can transmit either up to +22dBm on the High-Power PA, or up to +15dBm on the Low Power TX path, and supports a continuous low power operation in the 150MHz-960MHz ISM bands. Its main features are:

- Low-Power High-Sensitivity LoRa/(G)FSK Half-Duplex RF Transceiver
- Worldwide ISM frequency bands support in the range 150 - 960MHz
- Low Noise Figure RX front-end for enhanced LoRa/ (G) FSK sensitivity
- High power PA path +22 dBm
- High efficiency PA path +15 dBm
- Integrated PA regulator supply selector to simplify dual power +15/+22dBm with one board implementation
- Able to support world-wide multi-region BOM, the circuit adapts to matching network to satisfy regulatory limits
- Fully compatible with the SX1261/2/8 family and the LoRaWAN® standard, defined by the LoRa Alliance®

2. REFERENCE DESIGN

The IoT world is constantly growing with an endless number of different applications to monitor any parameter you can imagine. A wireless connection is required for all of them to transfer the collected data from the edge to the cloud. For those devices in constant movement, the challenge is even higher, since further to the wireless connection, a positioning mechanism is also required. This positioning system is usually based on GNSS, but it struggles under some adverse conditions, such as indoor environments, where Wi-Fi solutions seem to be a good alternative. The big challenge relies on effectively accommodating these three different wireless services in an IoT device, usually featured by small dimensions. This is exactly the aim of this application note.

Ignion and SEMTECH have joined efforts to develop a reference design for any IoT device requiring connectivity in three different radios simultaneously. Namely, upper UHF bands, hereafter referred to as LoRa bands, where unlicensed LPWA connectivity is available, anywhere from 863 to 928 MHz, GNSS coverage including GPS, Galileo, GLONASS, and BeiDou (1561 – 1606MHz), and lastly 2400 to 2500 MHz for the Wi-Fi 802.11 band.

The solution integrates one TRIO mXTEND™ chip antenna component. Featuring reduced dimensions of just 30 mm x 3 mm x 1 mm, TRIO mXTEND™ is the only antenna available in the market capable of handling the three radios at the same time in the same single antenna package. Its miniature, off-the-shelf, multiband, high-efficiency, and tunable features make it ideal for its use in combination with Semtech's LR1110 chip, which is also capable of managing the three radios at the same time. It integrates together a LoRa® transceiver, a LoRaWAN modem, device, and application services, as well as a Wi-Fi b/g/n scanner and a hybrid GPS/BeiDou scanner.

The performance of any antenna is strongly conditioned by the ground plane size of the device where it is integrated. Therefore, a set of different boards sizes are used to represent different IoT devices that are analyzed to gather the TRIO mXTEND™ performance variations according to different conditions. Some cases call for extremely small, highly integrated asset trackers, but a certain board size is needed to maintain a minimum required performance.

Based on Ignion proprietary Virtual Antenna™ technology, the TRIO mXTEND™ chip antenna component used in this reference design belongs to this new generation of miniature, off-the-shelf antenna solutions specially thought to drive fast and intelligent design. Its frequency neutral characteristic allows the designer to easily select the operating frequencies according to their needs, not already pre-set by the antenna geometry, as happen with other antenna solutions. This modular design reduces considerably the integration complexity while saving cost, time, and space. It has been specifically designed to fit a diverse set of wireless applications – IoT trackers are just one of the many environments where this technology can be transformational.

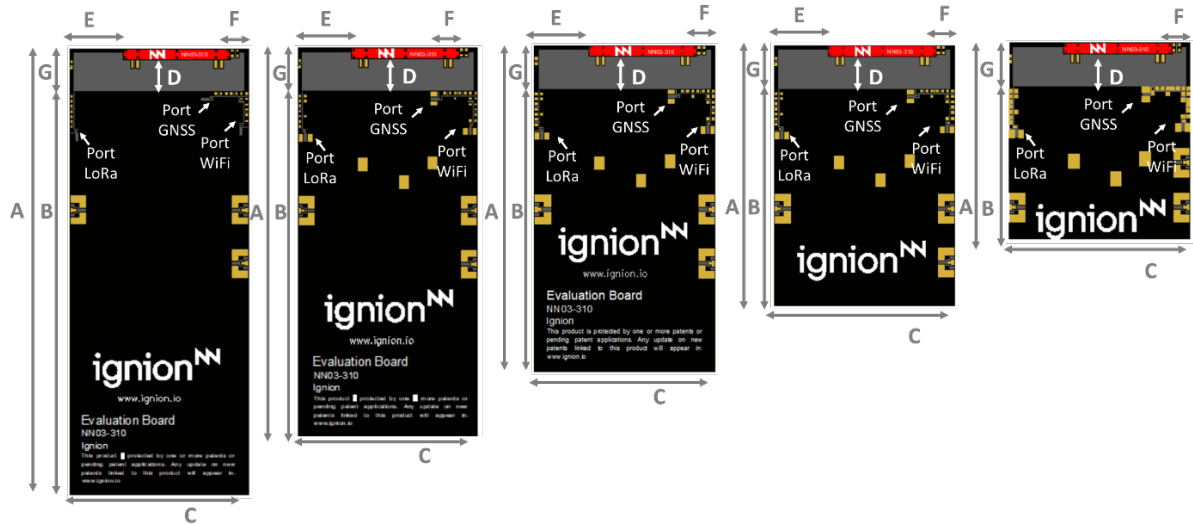

Figure 1 - Evaluation Board for providing operation at 863 to 928 MHz (Port 1), 1561 – 1606MHz (Port 2) and 2400 – 2500MHz (Port 3).

Measure	mm
A	125 - 54
B	110 - 39
C	50
D	9
E	15
F	5
G	12

Tolerance: ±0.2 mm

D: Distance between the TRIO mXTEND™ chip antenna component and the ground plane.

Material: The Evaluation Board is built on FR4 substrate. Thickness is 1 mm.

Clearance Area: 50.0 mm x 12.0 mm (C x G)

2.1. MATCHING NETWORK

The board size impacts the performance of any antenna. The advantage of using the TRIO mXTEND[™] is that a matching network for each antenna port (LoRa, GNSS, and Wi-Fi) can be used to easily retune the antenna for ensuring that the power delivered by the RF module is always effectively radiated. In contrast to what happens with other antenna solutions, the detuning effect appearing when modifying the board size can be easily compensated through the adjustment of the matching network components. IoT designers do not need to make a complete re-design of the board from scratch anymore. They just need to adapt the frequency response through the variation of the matching network components according to the new PCB (Printed Circuit Board) conditions, without requiring any PCB re-layout. This section will present the proposed matching network and specs obtained in the corresponding evaluation boards of different representative IoT device sizes (Figure 1). The recommended chip component and matching network layout are depicted in Figure 3 and Figure 4.

All matching networks depicted below were designed with the objective of obtaining the lowest reflection coefficient (S_{11}) and the highest antenna efficiency in the frequency bands required to cover the whole spectrum (Figure 4, Figure 5, Figure 6). From 863-928MHz for the LoRa case, 1561-1606 MHz for GNSS, and 2400 -2500MHz for Wi-Fi. The PCB size affects the performance of any antenna, not only in terms of radiation efficiency, but also in terms of impedance. This may mean detuning, which can be easily solved in Virtual Antenna[™] solutions, such as the TRIO mXTEND[™] by readjusting the matching networks properly. That is why each PCB size has its own matching networks to optimize the performance in the three bands. The minimum number of components for this purpose is used to reduce as much as possible their associated losses. The use of high-quality factor (Q) and tight tolerance components (e.g. Murata components (Figure 4, Figure 5, Figure 6)) is recommended to avoid undesired efficiency losses in the matching network, and to ensure the repeatability of the solution.

As already introduced, the antenna performance is always conditioned by its operating environment. Please note that different devices with different ground planes, different printed circuit board sizes, different components nearby the antenna, LCD's, batteries, covers, connectors, etc. may need a different matching network. To ensure optimal performance, placing pads compatible with 0402 and 0603 SMD components is recommended. Place them as close as possible to the feeding point of the antenna element in the ground plane area, not in the clearance area. This provides a degree of freedom to tune the TRIO mXTEND[™] chip antenna component once the design is finished and considering all elements of the system (batteries, displays, covers, etc.) (Figure 2).

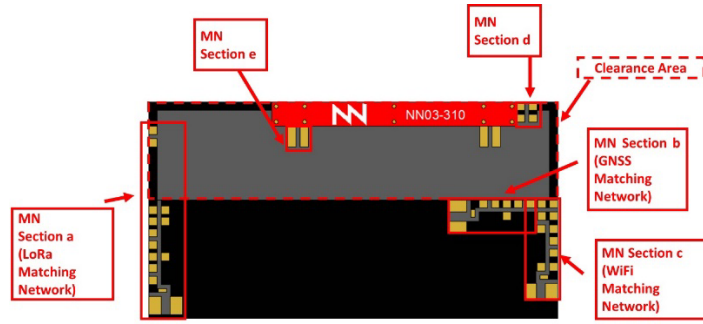

Figure 2 –TRIO mXTEND™ matching network layout

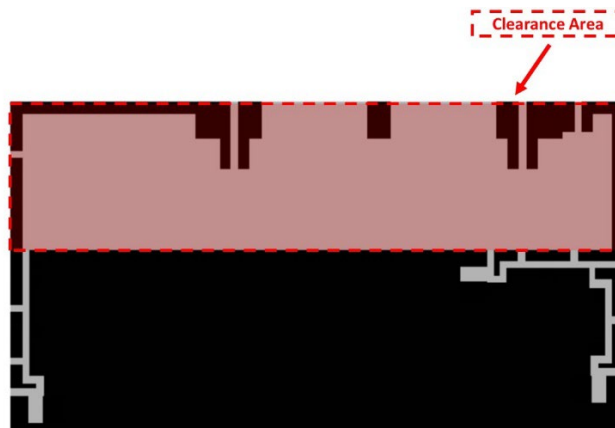

Figure 3 – TRIO mXTEND™ chip antenna component footprint

863 – 928 MHz, 1561 – 1606MHz and 2400 – 2500MHz	
MN Section a	
MN Section b	
MN Section c	

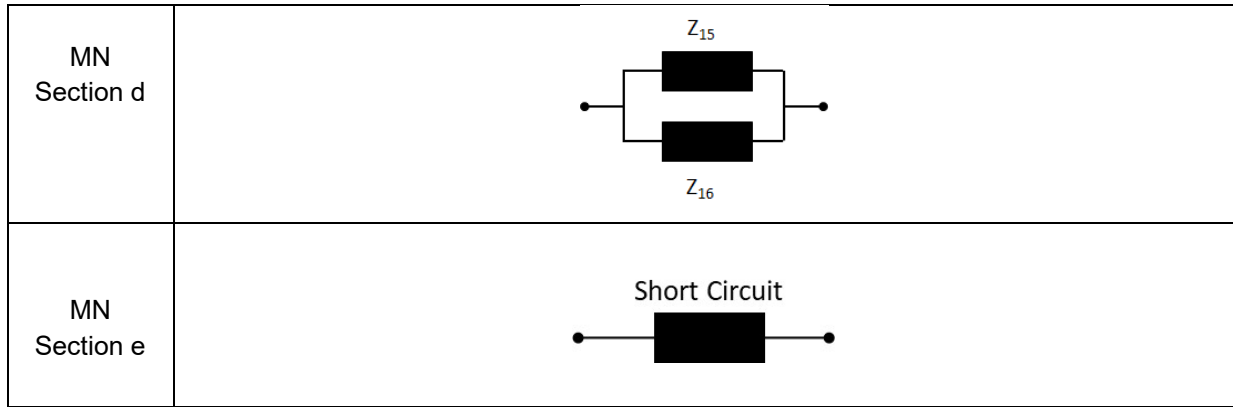

Figure 4 – Matching Networks implemented in the Evaluation Board (Figure 1).

	Z1	Z2	Z3	Z4	Z5	Z6	Z7	Z8	Z9	Z10	Z11	Z12	Z13	Z14	Z15	Z16
PCB125x50	15nH	2.3pF	Open	4.0nH	Open	0Ω	9.1nH	2.3pF	4.4nH	6.0nH	1.6pF	0.7pF	2.2nH	8.4nH	28nH	0.8pF
PCB108x50	16nH	1.9pF	Open	1.3nH	Open	0Ω	10nH	2.2pF	2.3nH	8.4nH	1pF	0.5pF	1.8nH	Open	28nH	0.8pF
PCB90x50	3.7nH	10pF	Open	10pF	3.7nH	0Ω	7.5nH	3.2nH	1.7pF	8.4nH	1pF	8.7nH	5.6nH	Open	-	0.1pF
PCB72x50	0Ω	4nH	Open	0Ω	Open	0Ω	9.1nH	5.6nH	0Ω	8.4nH	1pF	9.1nH	5.6nH	Open	-	0.1pF
PCB54x50	4nH	Open	18pF	12pF	2.8nH	0Ω	8.7nH	3.5nH	0Ω	8.4nH	1pF	8.7nH	5.6nH	Open	-	0.1pF

Value Inductor	Part Number
28nH	LQW18AN28NG80
16nH	LQW18AN16NG80
15nH	LQW18AN15NG80
10nH	LQW18AN10NG10
9.1nH	LQW18AN9N1G80
8.7nH	LQW18AN8N7G80
8.4nH	LQW18AN8N4G80
7.5nH	LQW18AN7N5C80
6.0nH	LQW5AN6N0B80
5.6nH	LQW15AN5N6C10
4.4nH	LQW15AN4N4G80
4.0nH	LQW15AN4N0G80
3.7nH	LQW15AN3N7G80
3.5nH	LQW15AN3N5G80
3.2nH	LQW15AN3N2B00
2.8nH	LQW15AN2N8G80
2.3nH	LQW15AN2N3G80
2.2nH	LQW15AN2N2C10
1.8nH	LQW15AN1N8C00
1.3nH	LQW15AN1N3C10

Value Capacitor	Part Number
18pF	GJM1555C1H180FB01
12pF	GJM1555C1H120FB01
10pF	GJM1555C1H100FB01
2.3pF	GJM1555C1H2R3WB01
2.2pF	GJM1555C1H2R2WB01
1.9pF	GJM1555C1H1R9WB01
1.7pF	GJM1555C1H1R7WB01
1.6pF	GJM1555C1H1R6WB01
1.0pF	GJM1555C1H1R0WB01
0.8pF	GJM1555C1HR80WB01
0.7pF	GJM1555C1HR70WB01
0.5pF	GJM1555C1HR50WB01
0.1pF	GJM1555C1HR10WB01

Table 1 - Values of the components for each different solution

If you need assistance to design your matching network beyond this application note, please contact support@ignion.io, or if you are designing a **different device size** or a **different frequency band**, we can assist you in less than 24 hours. Please, try our free-of-charge¹ [Antenna Intelligence Cloud](#), which will get you a complete design report including a custom matching network for your device in 24h¹. Additional information related to NN's range of R&D services is available at: <https://ignion.io/rdservices/>

¹ See terms and conditions for a free Antenna Intelligence Cloud service in 24h at: <https://www.ignion.io/antenna-intelligence/>

2.2. VSWR AND EFFICIENCY

The TRIO mXTEND™ antenna offers a wide bandwidth, allowing for a single tuning for all frequency band across the different PCB sizes for LoRa frequencies ranging from 863-928MHz, GNSS (1561-1606MHz), and Wi-Fi (2400-2500MHz) (Figure 5). The VSWR is below 3 for the whole three frequency ranges.

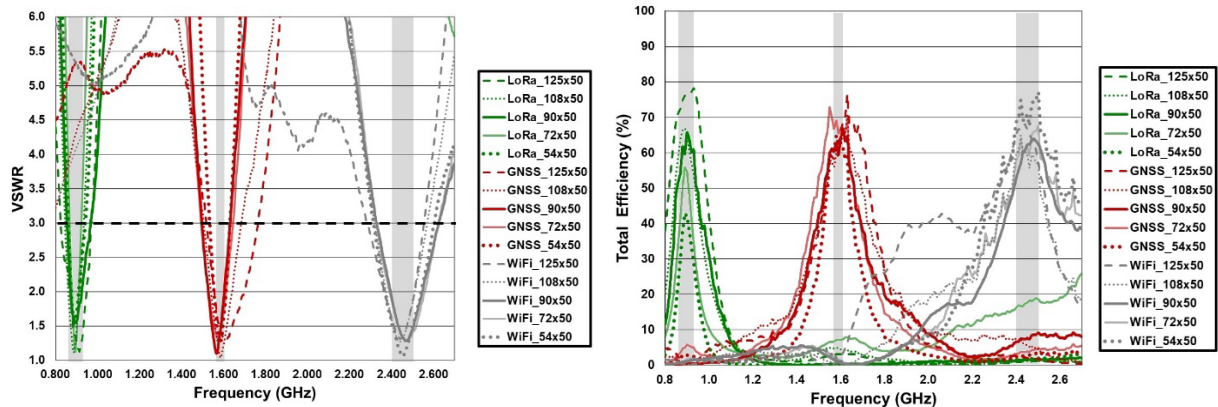

Figure 5 – VSWR and total efficiency for the different bands covered by the different sized evaluation boards from Figure 1.

PCB Dimensions (A x C)	LoRa (863 – 928 MHz)				
	η_a 863 MHz	η_a 928 MHz	Min	Max	Av. η_a
125mm x 50mm	71.5	78.1	71.5	78.1	75.5
108mm x 50mm	60.6	54.2	54.2	66.9	62.5
90mm x 50mm	52.4	60.9	52.4	65.8	60.6
72mm x 50mm	36.5	35.9	55.8	35.9	47.3
54mm x 50mm	25.1	29.6	25.1	42.8	36.4

PCB Dimensions (A x C)	GNSS (1561 – 1606 MHz)					WiFi (2400 – 2500 MHz)				
	η_a 1561 MHz	η_a 1606 MHz	Min	Max	Av. η_a	η_a 2400 MHz	η_a 2500 MHz	Min	Max	Av. η_a
125mm x 50mm	58.8	67.7	58.2	67.7	62.0	65.5	57.2	57.2	68.0	64.8
108mm x 50mm	57.1	64.3	56.0	64.3	59.4	60.1	56.7	55.5	65.0	59.4
90mm x 50mm	61.1	65.8	59.5	65.8	61.9	53.1	62.4	53.1	64.0	60.6
72mm x 50mm	69.5	66.9	65.4	69.5	67.3	57.9	67.3	57.9	67.6	62.5
54mm x 50mm	60.2	62.1	60.2	64.9	62.4	68.8	76.7	67.6	77.1	71.9

Table 2 – Total efficiency (%) comparison considering the different PCB sizes (Figure 1)

The total antenna efficiency, which includes mismatch effects, decreases for the LoRa bands with the PCB size. From the average 76% antenna efficiency obtained for the larger PCB size (125 mm x 50 mm) to 36% for the shorter PCB size (54 mm x 50 mm). This is a 3 dB hit on the antenna performance for the smaller object, still good enough for certain conditions. The Wi-Fi band and GNSS frequencies are less dependent of the PCB size. It just varies from 67% to 59% in the GNSS case, and from 72% to 59% for the Wi-Fi case.

2.3. TRANSMISSION COEFFICIENT

The transmission coefficient between the three ports is well below -10dBs in the frequency bands of interest for all the cases gathered herein (Figure 6).

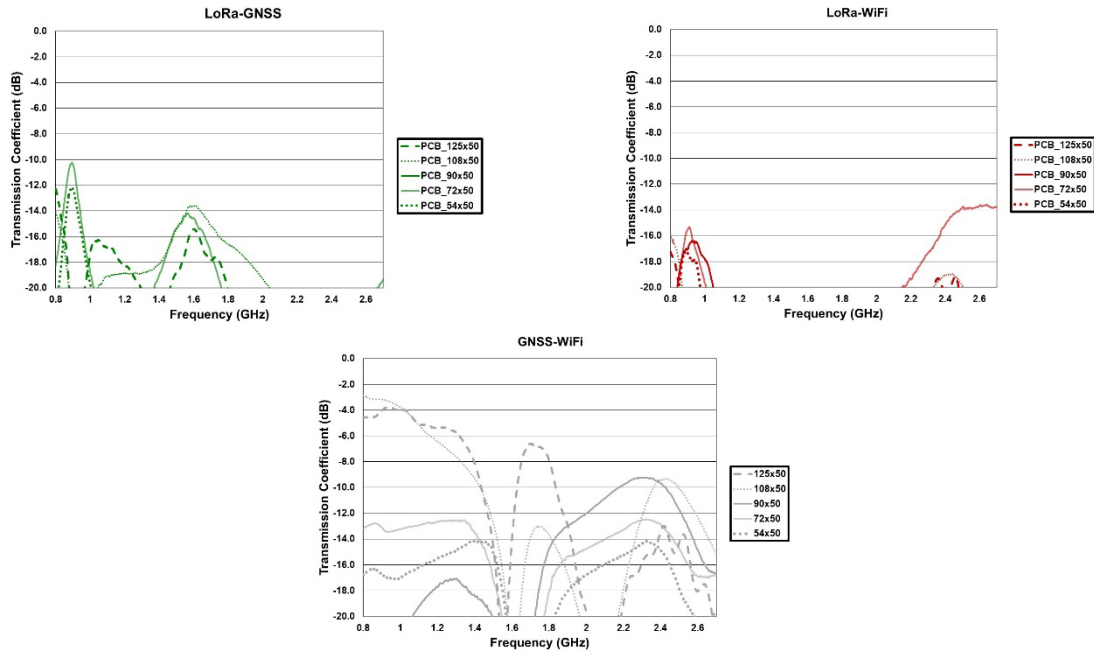

Figure 6 –Transmission coefficients between the ports of the Evaluation Board from Figure 1.

2.4. RECOMMENDED ANTENNA FOOTPRINT FOR NN03-310

The TRIO mXTEND™ chip component (NN03-310) must be placed in the clearance area of the PCB. The minimum clearance area recommended for this application is 50 mm x 12 mm. See below the recommended footprint dimensions, to provide operation from 863 to 928MHz at port 1, 1561-1606 MHz at port 2, from 2400MHz to 2500MHz at port 3.

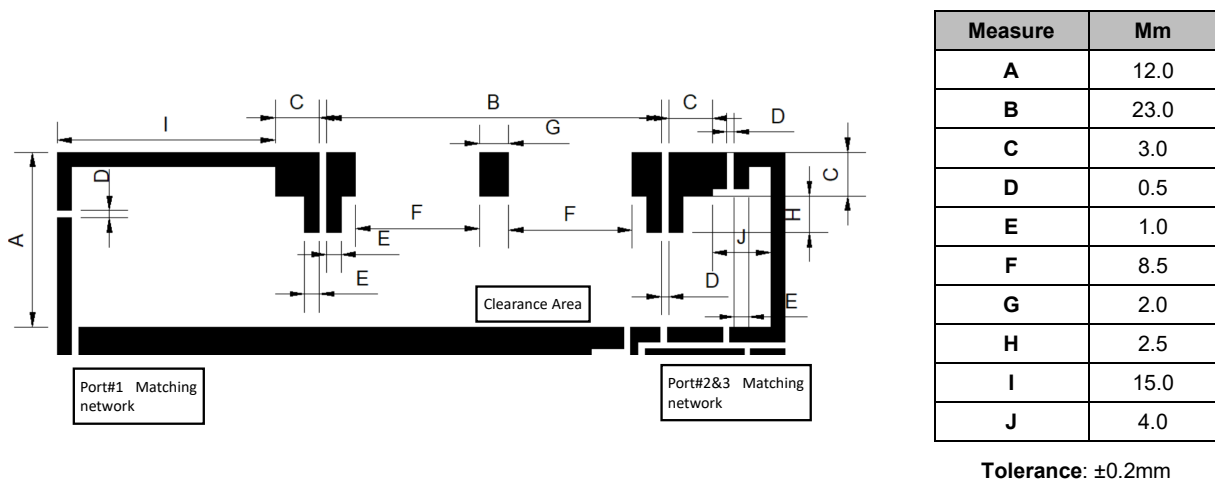
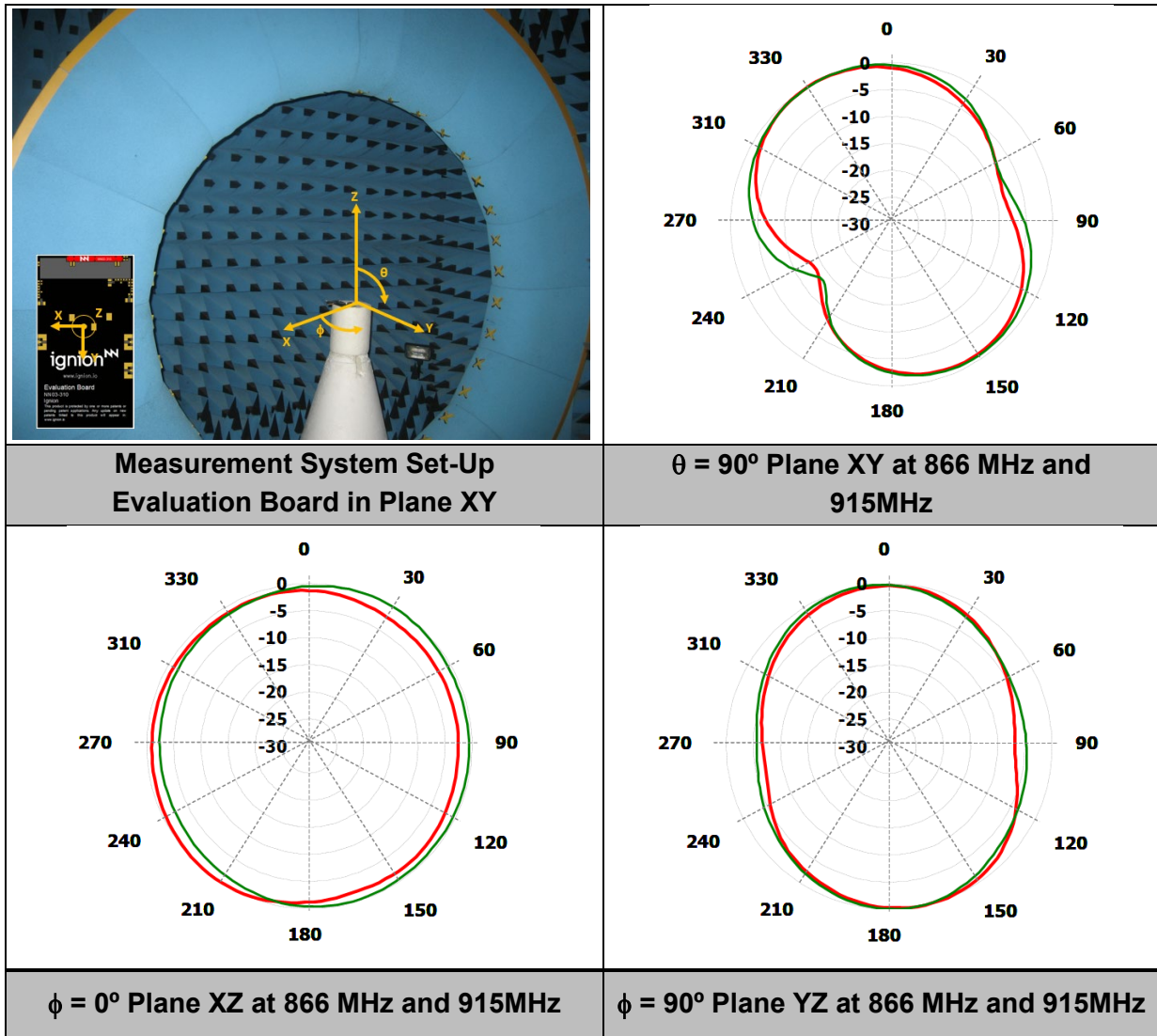

Figure 7 – Footprint dimensions for the NN03-310 chip antenna component.

2.5. RADIATION PATTERNS (LoRa), GAIN, AND EFFICIENCY

The TRIO mXTEND™ antenna has an omni-directional pattern for all board sizes and frequency bands. This is an important feature when, typically, the orientation of the IoT device is unknown. See below the measured radiation patterns for the reference PCB size (90mm x 50 mm).



Gain	Peak Gain	0.8 dBi
	Average Gain across the band	0.3 dBi
	Gain Range across the band (min, max)	0.0 <-> 0.8 dBi
Efficiency	Peak Efficiency	65.8 %
	Average Efficiency across the band	60.5 %
	Efficiency Range across the band (min, max)	52.4 – 65.8 %

Table 3 – Antenna Gain and total efficiency from the evaluation board of size 90x50 port 1 (Figure 1) within the 863MHz – 928MHz frequency range.

2.6. RADIATION PATTERNS (GNSS), GAIN, AND EFFICIENCY

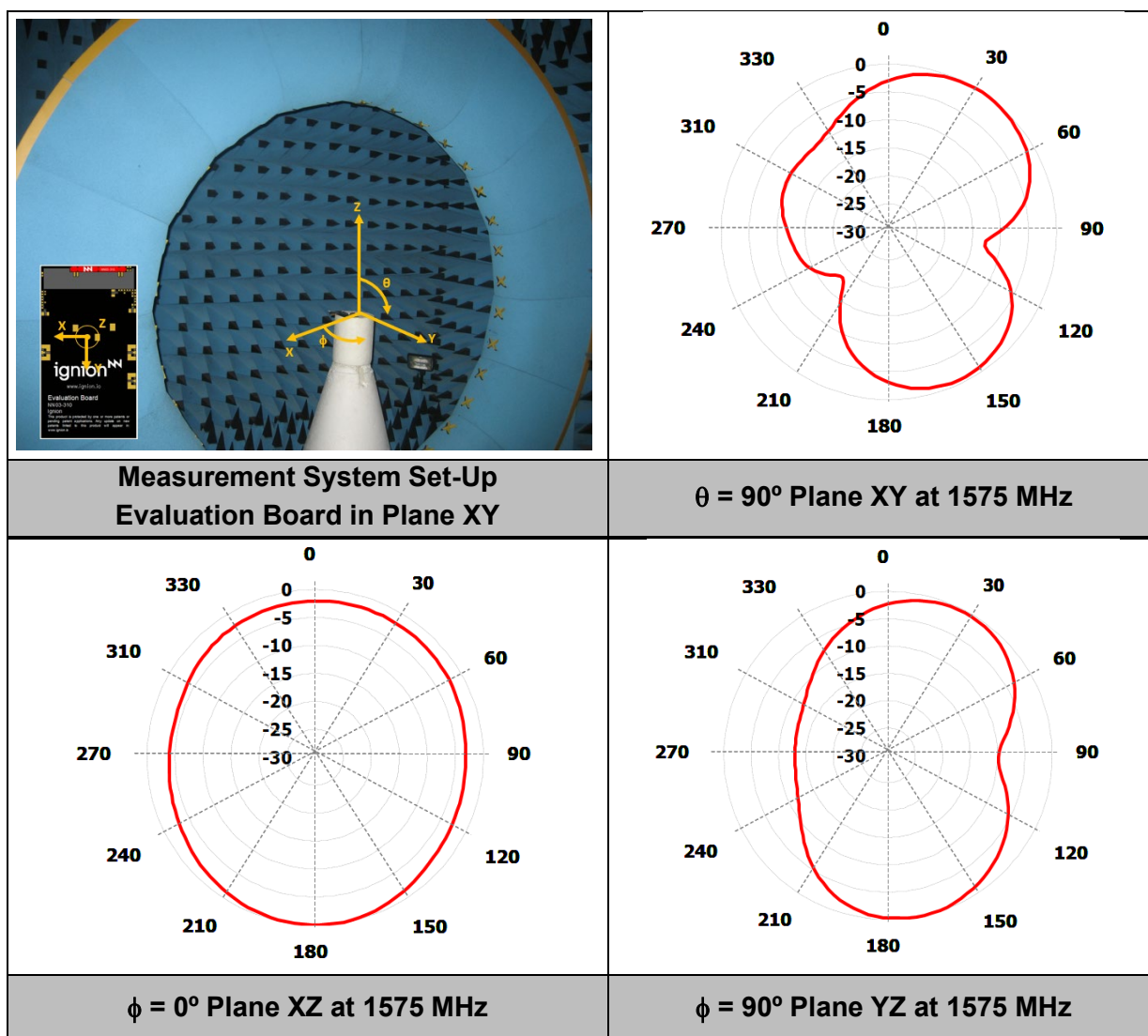

Gain	Peak Gain	1.9 dBi
	Average Gain across the band	1.5 dBi
	Gain Range across the band (min, max)	1.3 <-> 1.9 dBi
Efficiency	Peak Efficiency	65.8 %
	Average Efficiency across the band	61.8 %
	Efficiency Range across the band (min, max)	59.5 – 65.8 %

Table 4 – Antenna gain and total efficiency from the evaluation board of size 90x50 port 2 (Figure 1) within the 1561Hz – 1606MHz frequency range.

2.7. RADIATION PATTERNS (Wi-Fi 2.4GHz), GAIN, AND EFFICIENCY

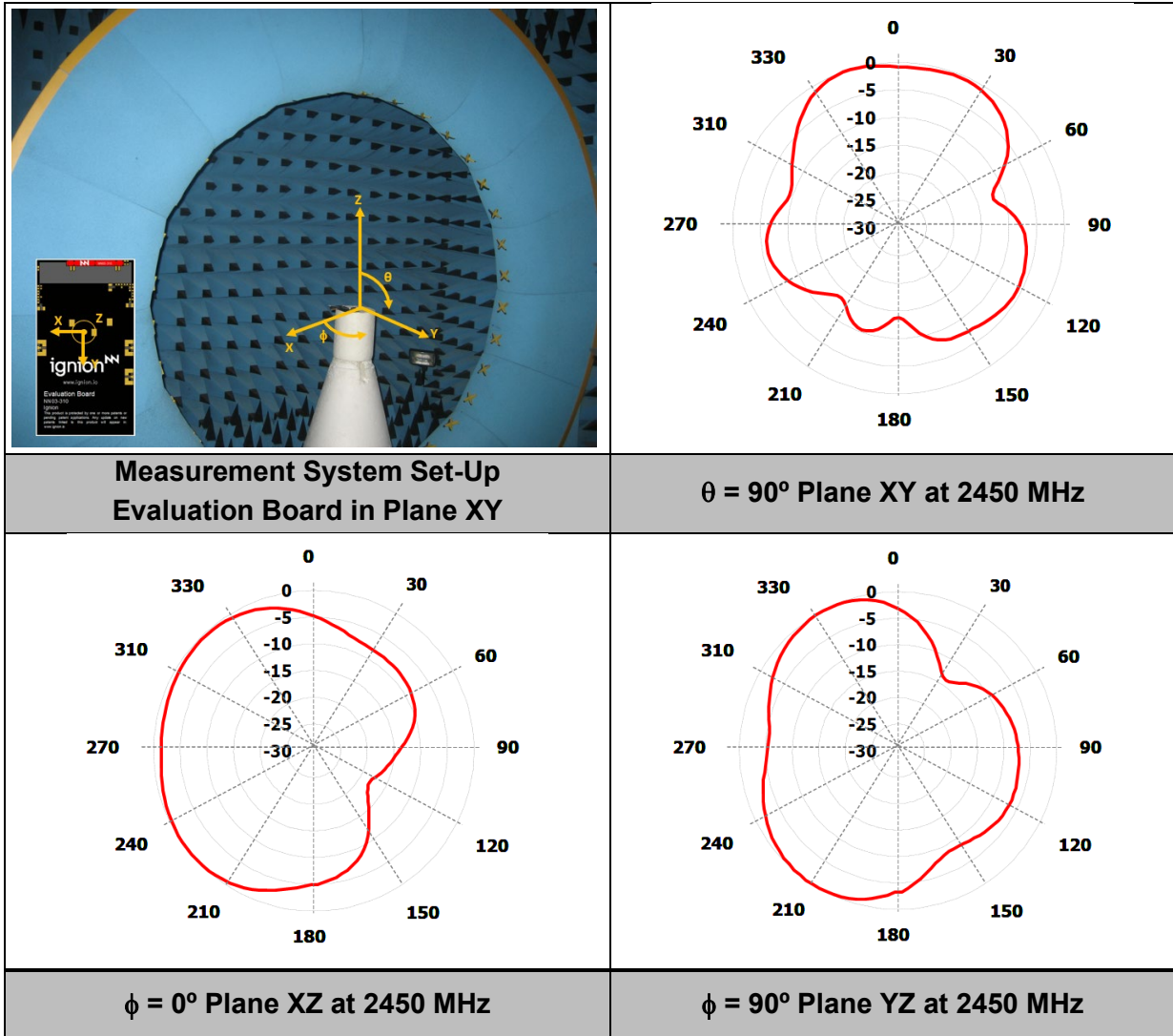

Gain	Peak Gain	3.7 dBi
	Average Gain across the band	3.5 dBi
	Gain Range across the band (min, max)	3.1 \leftrightarrow 3.7 dBi
Efficiency	Peak Efficiency	64.0 %
	Average Efficiency across the band	60.6 %
	Efficiency Range across the band (min, max)	53.1 – 64.0 %

Table 5 – Antenna gain and total efficiency from the evaluation board of size 90x50 port 3 (Figure 1) within the 2400Hz – 2500MHz frequency range.

3. PERFORMANCE IN DIFFERENT PCB SIZES

The results above conclude that the TRIO mXTEND is a suitable antenna capable of working at LoRa, GNSS and Wi-Fi at the same time. In terms of PCB size, the larger the PCB the higher performance is expected. Apart from that, any change in the antenna impedance due to the PCB size or a change in the environment conditions can easily be compensated through the matching network. This is one of the advantages of Virtual Antenna™ Technology, which can work at any standard and under different conditions by using the same antenna component, just adjusting the matching network. Unlike what happens with other conventional antenna solutions, which are difficult to adjust to the bands of interest once they are integrated inside the device due to their self-resonance characteristics determined by their geometry. This fact increases NREs and design cycles.

4. PERFORMANCE IN DIFFERENT ENVIRONMENTS

IoT applications are diverse: smart home, smart cities, smart utility, smart farming, asset tracking, etc. This wide variety of applications directly translate into a wide variety of devices with different form factors and different environmental conditions. Some devices could usually be placed near certain elements that could affect their performance like walls, containers, animals, and pallets for logistic purposes. The impact of these materials over the antenna performance when placed in its vicinity is analyzed herein. Namely, the materials assessed are concrete, wood, metal, and body phantom (this last element was modeled using a recipient filled with the corresponding phantom liquid emulating the electromagnetic properties of the human tissue at the frequency regions of interest). Four different distances between the PCB of 90mm x 50mm and the surrounding material: 20mm, 15mm, 10mm and 5mm have been analyzed. The matching network used in this analysis always remains the same to evaluate the shifting in frequency, if any, introduced by each material.

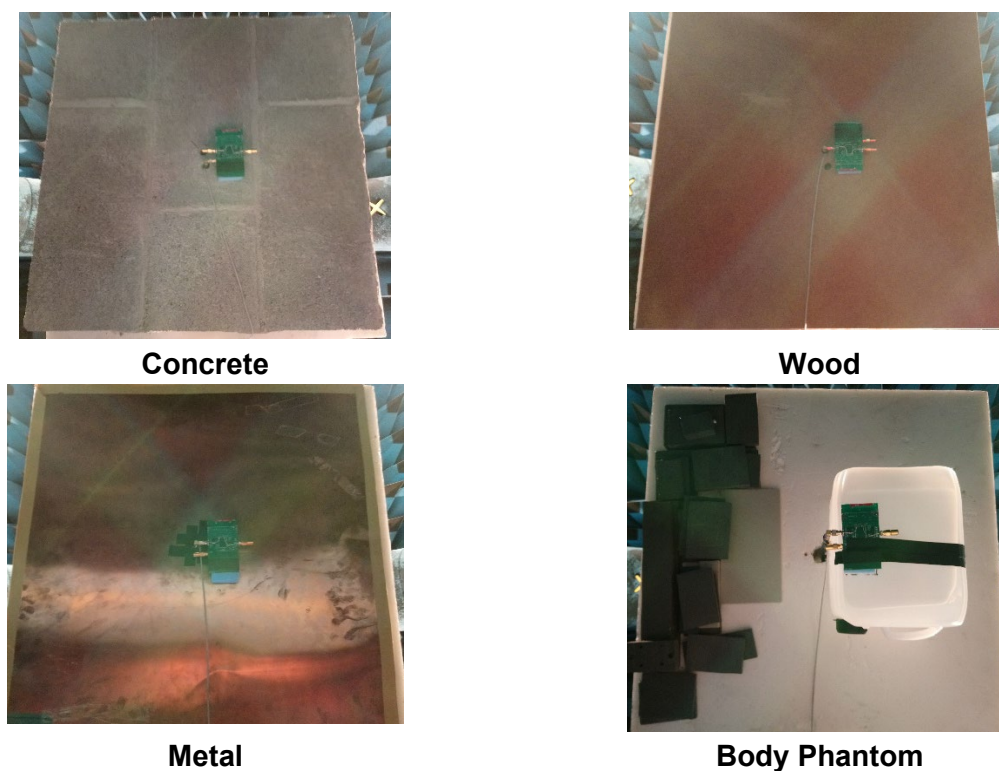

Figure 8 - Set-ups analyzed considering four different materials: concrete, body phantom, metal and wood. Distances evaluated: 20mm, 15mm, 10mm and 5mm

4.1. VSWR AND TOTAL EFFICIENCY

The materials in the surroundings of any radiating system can modify the antenna performance, not only in terms of detuning but also in terms of radiation efficiency. The detuning effect can be easily solved with Virtual Antenna[™] technology which allows an easier and faster retuning of the radiating system under the environmental conditions of operation. This retuning is not possible with other antenna technologies without implying a board redesign, higher NREs, and longer design cycles. The results gathered in the next section show that the underlying material and more importantly the distance to it, plays a critical role in the antenna performance, both in terms of mismatch losses, but also in terms of efficiency.

4.2. CONCRETE

According to Figure 9 and Table 6, concrete is a material that causes a certain drop in efficiency, especially at Wi-Fi, but no shifting in frequency is appreciated, so there is no need of a readjustment of the matching network. Generally, the nearer the antenna is from the material, the lower the efficiency. In sum, the antenna seems to be rather robust to the presence of this material and the performance is maintained reasonably high.

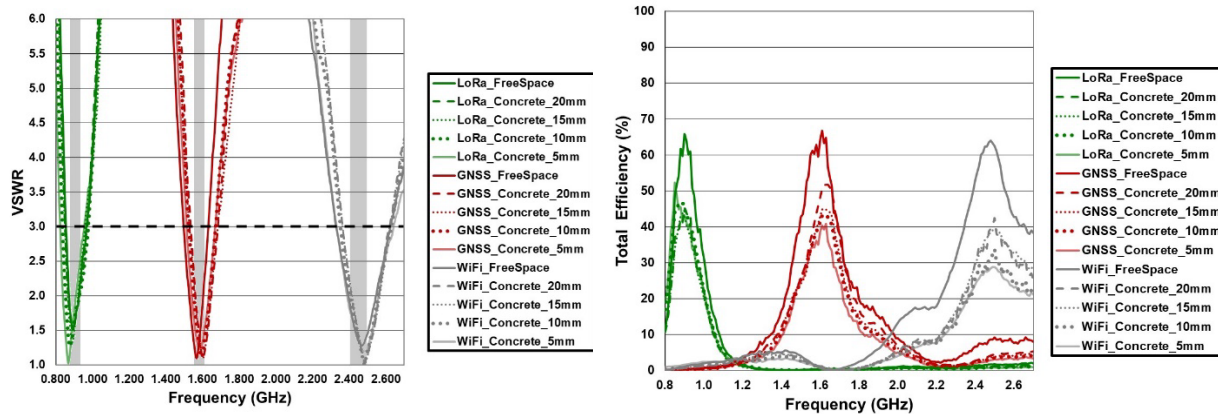

Figure 9 – VSWR and total efficiency for the different bands covered by the Evaluation Board from Figure 1 and considering the presence of concrete. The matching network used is always the same like the case 90mm x 50mm in free-space Figure 4 and Table 1.

Concrete PCB (90 x 50)	LoRa (863 – 928 MHz)				
	η_a 863 MHz	η_a 928 MHz	Min	Max	Av. η_a
Distance 20mm	38.1	43.3	38.1	45.3	42.3
Distance 15mm	37.9	37.5	37.5	43.7	41.1
Distance 10mm	45.7	40.7	40.7	46.8	44.8
Distance 5mm	47.5	40.3	39.6	47.5	42.8

Concrete PCB (90 x 50)	GNSS (1561 – 1606 MHz)					WiFi (2400 – 2500 MHz)				
	η_a 1561 MHz	η_a 1606 MHz	Min	Max	Av. η_a	η_a 2400 MHz	η_a 2500 MHz	Min	Max	Av. η_a
Distance 20mm	38.7	49.7	38.7	49.7	44.3	30.2	42.4	30.2	42.5	35.8
Distance 15mm	35.5	44.1	35.5	44.1	40.0	29.7	39.3	29.7	39.3	35.5
Distance 10mm	35.5	42.5	35.5	42.5	39.1	25.9	33.6	25.9	33.7	29.3
Distance 5mm	34.3	39.7	34.3	39.7	36.0	24.0	28.8	24.0	28.8	27.1

Table 6 - Total efficiency (%) comparison in presence of concrete (Figure 8) considering a PCB size of 90mm x 50mm (Figure 1) and four distances between and the PCB and the material: 20mm, 15mm, 10mm and 5mm

4.3. WOOD

In contrast to concrete, the antenna performance in presence of wood hardly changes as it is shown in Figure 10 and Table 7. The only remarkable effect is a little shifting in GNSS, which can be easily balanced through the matching network. Then it can be concluded that the antenna is highly robust to this material.

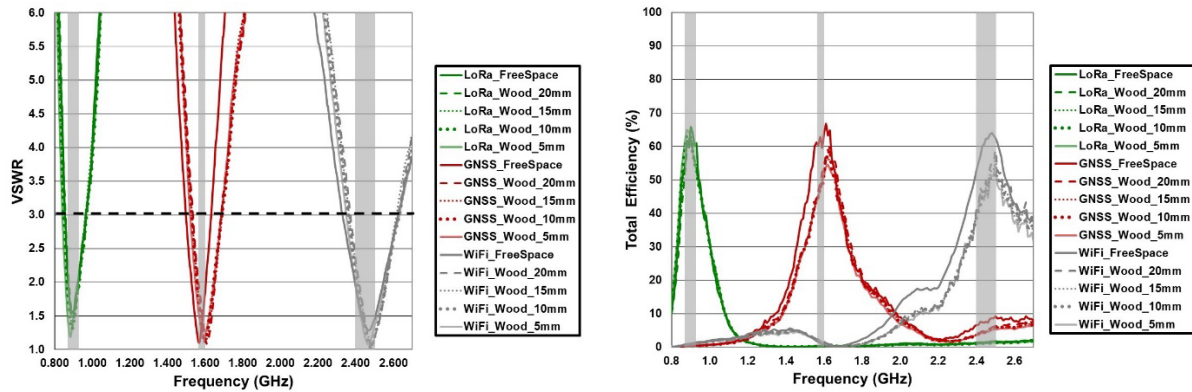

Figure 10 – VSWR and total efficiency for the different bands covered by the evaluation board from Figure 1 and considering the presence of wood. The matching network used is always the same like the case 90mm x 50mm in free-space Figure 4 and Table 1.

Wood PCB (90 x 50)	LoRa (863 – 928 MHz)				
	η_a 863 MHz	η_a 928 MHz	Min	Max	Av. η_a
Distance 20mm	48.1	54.3	48.1	62.6	57.7
Distance 15mm	51.0	53.8	51.0	62.5	58.4
Distance 10mm	56.1	53.3	53.3	63.5	59.7
Distance 5mm	58.6	53.2	53.2	64.9	60.5

Wood PCB (90 x 50)	GNSS (1561 – 1606 MHz)					WiFi (2400 – 2500 MHz)				
	η_a 1561 MHz	η_a 1606 MHz	Min	Max	Av. η_a	η_a 2400 MHz	η_a 2500 MHz	Min	Max	Av. η_a
Distance 20mm	45.1	56.5	45.1	56.5	50.5	41.3	58.8	41.3	58.8	49.5
Distance 15mm	44.1	54.7	44.1	54.7	49.0	40.5	56.3	40.5	56.3	47.8
Distance 10mm	44.8	55.3	44.7	55.3	48.4	39.0	51.4	39.0	51.5	46.9
Distance 5mm	43.6	53.0	43.6	53.0	48.0	40.2	54.2	40.2	54.3	46.8

Table 7 - Total efficiency (%) comparison in presence of Wood (Figure 8) considering a PCB size of 90mm x 50mm (Figure 1) and four distances between and the PCB and the material: 20mm, 15mm, 10mm and 5mm

4.4. METAL

Metal is probably the most critical environment where the antenna can be. As Figure 11 and Table 8 show, its impact on the antenna performance is considerable, especially for the lowest band: LoRa. The worst case is considered herein since the antenna is placed in the middle of a 1m x 1m metal surface (Figure 8).

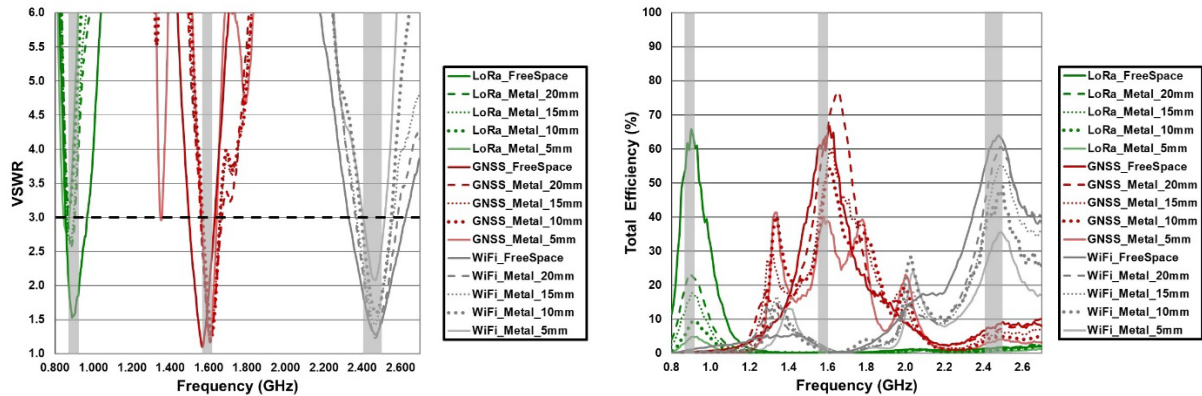

Figure 11 – VSWR and total efficiency for the different bands covered by the evaluation board from Figure 1 and considering the presence of metal. The matching network used is always the same like the case 90mm x 50mm in free-space Figure 4 and Table 1.

Metal PCB (90 x 50)	LoRa (863 – 928 MHz)				
	η_a 863 MHz	η_a 928 MHz	Min	Max	Av. η_a
Distance 20mm	18.0	20.9	18.0	23.4	21.7
Distance 15mm	11.5	16.9	11.5	17.8	15.7
Distance 10mm	5.0	9.3	5.0	9.3	7.9
Distance 5mm	2.8	4.8	2.8	4.8	4.2

Metal PCB (90 x 50)	GNSS (1561 – 1606 MHz)					WiFi (2400 – 2500 MHz)				
	η_a 1561 MHz	η_a 1606 MHz	Min	Max	Av. η_a	η_a 2400 MHz	η_a 2500 MHz	Min	Max	Av. η_a
Distance 20mm	53.8	68.2	53.8	68.2	61.4	42.1	60.1	42.1	60.7	54.1
Distance 15mm	42.0	58.6	42.0	58.6	50.1	35.8	55.0	35.8	55.2	48.1
Distance 10mm	37.5	53.5	37.5	53.5	46.8	35.4	48.8	35.4	48.9	42.5
Distance 5mm	35.9	38.5	35.9	40.2	38.3	23.7	35.1	23.7	35.6	31.2

Table 8 - Total efficiency (%) comparison in presence of metal (Figure 8) considering a PCB size of 90mm x 50mm (Figure 1) and four distances between and the PCB and the material: 20mm, 15mm, 10mm and 5mm

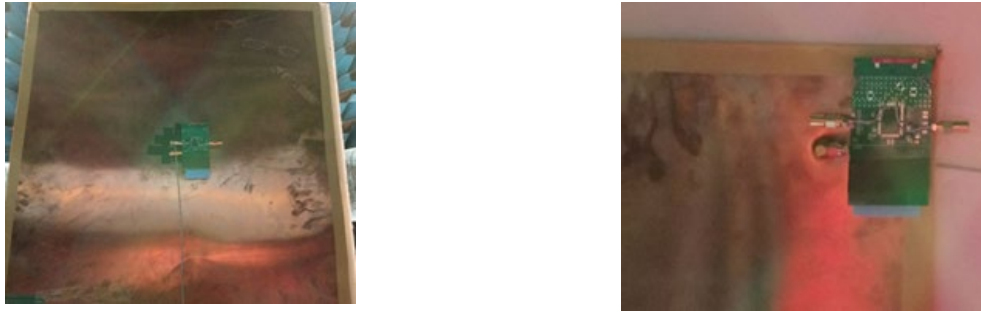

Figure 12 – Set-ups analyzed considering the presence of metal, 10mm of distance between the PCB and metal and two different positions: PCB located in the middle and PCB located on the corner.

To minimize the metal impact, is recommendable to locate the PCB so that the antenna is as close as possible to the corner of the metal surface. Like in other environments, the nearer the antenna is from metal, the higher the drop of antenna efficiency.

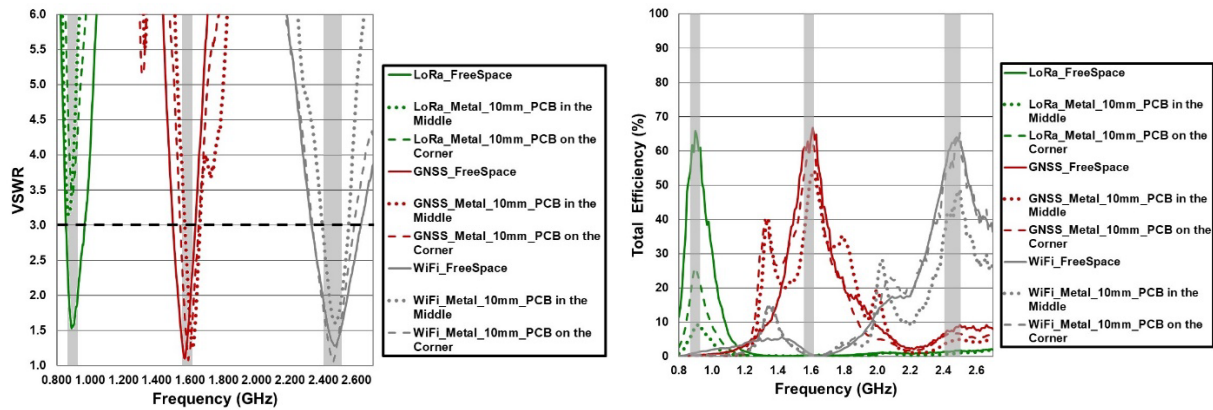

Figure 13 - VSWR and total efficiency for the different bands covered by the evaluation board from Figure 1 and considering the presence of metal and two different position: PCB in the middle and PCB on the corner. The matching network used is always the same like the case 90mm x 50mm in free-space Figure 4 and Table 1.

Metal PCB (90 x 50)	LoRa (863 – 928 MHz)				
	η_a 863 MHz	η_a 928 MHz	Min	Max	Av. η_a
Distance 10mm PCB in the Middle	5.0	9.3	5.0	9.3	7.9
Distance 10mm PCB on the Corner	15.2	21.4	15.2	25.9	22.4

Metal PCB (90 x 50)	GNSS (1561 – 1606 MHz)			WiFi (2400 – 2500 MHz)						
	η_a 1561 MHz	η_a 1606 MHz	Min	Max	Av. η_a	η_a 2400 MHz	η_a 2500 MHz	Min	Max	Av. η_a
Distance 10mm PCB in the Middle	37.5	53.5	37.5	53.5	46.8	35.4	48.8	35.4	48.9	42.5
Distance 10mm PCB on the Corner	53.8	62.4	53.8	62.4	59.3	50.9	65.2	50.9	65.3	58.0

Table 9 - Total efficiency (%) comparison in presence of metal (Figure 8) considering a PCB size of 90mm x 50mm (Figure 1), distances between and the PCB and the material of 10mm and two different locations: PCB in the Middle and PCB on the corner.

4.5. BODY PHANTOM

Like in metal, human/animal body interaction shows a considerable impact on the antenna performance, especially at the lowest band: LoRa (Figure 14 and Table 10). Additionally, a little shifting is experimented in GNSS, but it can be easily compensated by readjusting the matching network. Like for other materials, the further the antenna is from the material the higher the antenna performance. So it is recommended to leave as much distance as it is possible.

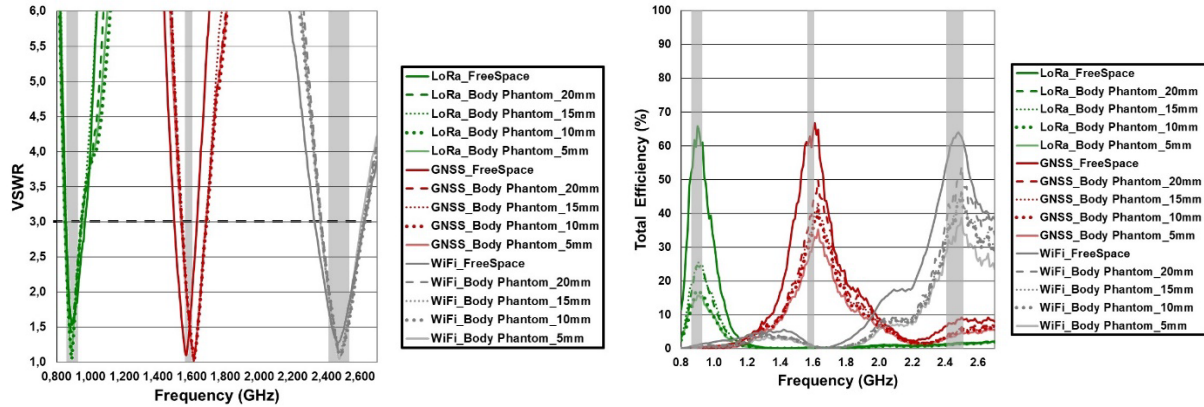

Figure 14 – VSWR and total efficiency for the different bands covered by the evaluation board from Figure 1 and considering the presence of body phantom. The matching network used is always the same like the case 90mm x 50mm in free-space Figure 4 and Table 1.

Phantom Body PCB (90 x 50)	LoRa (863 – 928 MHz)				
	η_a 863 MHz	η_a 928 MHz	Min	Max	Av. η_a
Distance 20mm	16.6	23.0	16.6	24.3	22.5
Distance 15mm	19.0	24.6	19.0	25.5	23.3
Distance 10mm	12.1	16.0	12.1	17.1	15.9
Distance 5mm	13.0	15.5	13.0	15.7	14.7

Phantom Body PCB (90 x 50)	GNSS (1561 – 1606 MHz)			WiFi (2400 – 2500 MHz)						
	η_a 1561 MHz	η_a 1606 MHz	Min	Max	Av. η_a	η_a 2400 MHz	η_a 2500 MHz	Min	Max	Av. η_a
Distance 20mm	34.1	45.0	34.1	45.0	39.1	36.8	53.8	36.8	53.8	45.0
Distance 15mm	30.6	39.7	30.6	39.7	34.5	32.4	46.6	32.4	46.7	39.2
Distance 10mm	28.6	37.3	28.6	37.3	32.6	31.4	45.8	31.4	45.8	38.3
Distance 10mm	25.3	32.5	25.3	32.5	28.6	28.0	38.6	28.0	38.7	33.1

Table 10 - Total efficiency (%) comparison in presence of phantom body (Figure 8) considering a PCB size of 90mm x 50mm (Figure 1) and four distances between and the PCB and the material: 20mm, 15mm, 10mm and 5mm

5. DESIGN RECOMMENDATIONS

This section is intended to provide general design recommendations to preserve the antenna performance when integrated in your device.

1. **Antenna placement:** Place the antenna as far as possible from other components, such as LCDs, batteries, connectors, especially those components and covers with metallic characteristics (see suitable placement in Figure 1).
2. **Clearance Area:** Keep the clearance area around the antenna component as recommended in the present report. The clearance area must be free from electronic components, traces and ground plane in all PCB layers including the underside of the PCB directly underneath the mounted antenna area. As general rule of thumb, the larger the clearance area the better the performance.
3. **PCB layers:** Ensure a continuous ground plane layer in at least one layer of your PCB design. Avoid any ground plane or conductive trace underneath the matching network pads area at a distance shorter than 1 mm from it.
4. **Matching Network:** Arrange pads for all the matching networks to host 0402/0603 SMD components if possible. Place pads as close as possible to the antenna feed point and within the ground plane area to enable an effective tuning of the matching networks components throughout your design. Use preferably **high Q and tight tolerance** matching network components.
5. **Transmission line and RF Chip:** Design your transmission line connecting the matching network to your RF chip (see scheme connecting in Figure 2) so that its characteristic impedance is 50Ω. The output impedance of your RF chip must feature 50Ω as well. Locate your RF chip as close as possible to the matching network in order to reduce the losses introduced by the transmission line.

To follow these design recommendations will make the design experience and certification process of the IoT device much smoother and easier.

6. CONCLUSIONS

The conclusions extracted from the analysis above can be summarized as:

1. TRIO mXTEND[™] is the only antenna available in the market capable of handling three radios (LoRa, GNSS, and Wi-Fi) inside the same single and compact antenna package, thus reducing integration complexity.
2. TRIO mXTEND[™] provides high performance in the three bands for the reference PCB size (90 mm x 50 mm). As general rule of thumb, the bigger the PCB, the better the performance.
3. The performance starts to degrade as the PCB shrinks, as also happens with other conventional antenna solutions. The advantage of the TRIO mXTEND[™] is that the detuning appearing due to the PCB size reduction can be easily compensated through the matching network adjustment, meaning that no customization of the antenna part is needed. This adjustment cannot be done in other conventional antenna solutions where the operating frequencies are mainly determined by the antenna geometry.
4. The radiation patterns are omnidirectional in all the cases, which becomes preferable when regarding devices in constant movement, where the direction of the incoming waves is unknown.
5. The materials in the vicinity affect to the radiation from two perspectives: antenna detuning and power absorption.
6. The TRIO mXTEND[™] presented is robust in terms of detuning to the proximity of the materials in the vicinity. The larger impact is appreciated for the metal case followed by the human body interaction.
7. If a detuning appears, it can be easily compensated through the proper adjustment of the matching network.
8. As general rule of thumb, the larger the distance the better the performance. For the most critical case, the metal scenario, it is recommended to place the device as close as possible to the edge of the metallic section at minimum distance of 25-30 mm. Even better performance is expected if the antenna area protrudes the metallic area.

Ignion products are protected by Ignion patents.

All information contained within this document is property of Ignion and is subject to change without prior notice. Information is provided “as is” and without warranties. It is prohibited to copy or reproduce this information without prior approval.

Ignion is an ISO 9001:2015 certified company. All our antennas are lead-free and RoHS compliant.

ISO 9001: 2015 Certified



ignion[™]

Your innovation.
Accelerated.

Contact:
support@ignion.io
+34 935 660 710

Barcelona

Av. Alcalde Barnils, 64-68 Modul C, 3a pl.
Sant Cugat del Vallés
08174 Barcelona
Spain

Shanghai

Shanghai Bund Centre
18/F Bund Centre, 222 Yan'an Road East,
Huangpu District
Shanghai, 200002
China

New Delhi

New Delhi, Red Fort Capital Parsvnath Towers
Bhai Veer Singh Marg, Gole Market,
New Delhi, 110001
India

Tampa

8875 Hidden River Parkway
Suite 300
Tampa, FL 33637
USA