

Data sheet | Item number: 282-865

3-conductor through terminal block; 6 mm²; with touch-proof test socket; e. g., current transformer circuits; center marking; for DIN-rail 35 x 15 and 35 x 7.5; CAGE CLAMP®; 6,00 mm²; gray

www.wago.com/282-865

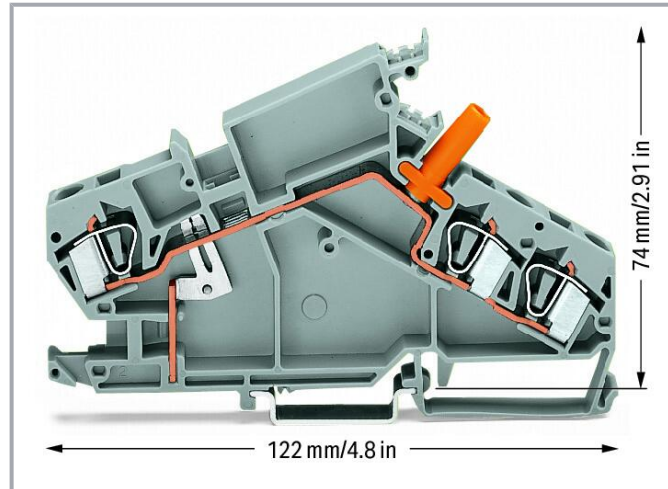
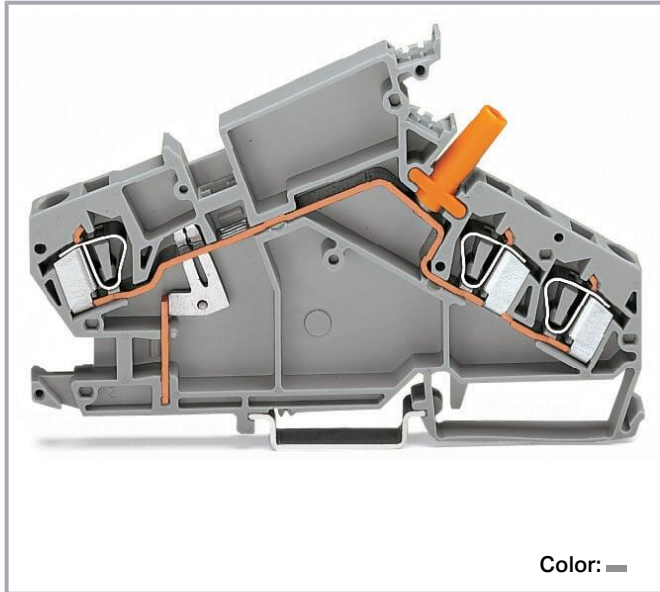

Data

Electrical data

Ratings per IEC/EN

Nominal voltage (III/3)	500 V
Rated impulse voltage (III/3)	6 kV
Rated current	30 A
Legend (ratings)	(III / 3) ≙ Overvoltage category III / Pollution degree 3

Power loss

Power loss, per pole (potential)	0.702 W
Rated current I_N for specified power loss	30 A
Resistance value for specified, current-dependent power loss	0.001 Ω

Connection data

Connection points	3
-------------------	---

Subject to changes. Please also observe the further product documentation!

WAGO GmbH & Co. KG
Hansastr. 27
32423 Minden
Phone: +49571 887-0 | Fax: +49571 887-169
Email: info.de@wago.com | Web: www.wago.com

Do you have any questions about our products?
We are always happy to take your call at +49 (571) 887-44222.



Total number of potentials	1
Number of levels	1

Connection 1

Connection technology	CAGE CLAMP®
Actuation type	Operating tool
Connectable conductor materials	Copper
Solid conductor	0.2 ... 6 mm ² / 24 ... 10 AWG
Fine-stranded conductor	0.2 ... 6 mm ² / 24 ... 10 AWG
Strip length	12 ... 13 mm / 0.47 ... 0.51 inches
Wiring direction	Front-entry wiring

Physical data

Width	8 mm / 0.315 inches
Height	122 mm / 4.803 inches
Depth from upper-edge of DIN-rail	74 mm / 2.913 inches

Mechanical Data

Design	angled
Mounting type	DIN-35 rail
Marking level	Center marking

Material Data

Note (material data)	Information on material specifications can be found here
Color	gray
Material group	I
Insulation material	Polyamide (PA66)
Flammability class per UL94	V0
Fire load	0.615 MJ
Weight	38.6 g

Environmental requirements

Processing temperature	-35 ... +85 °C
Continuous operating temperature	-60 ... +105 °C

Subject to changes. Please also observe the further product documentation!

WAGO GmbH & Co. KG
 Hansastr. 27
 32423 Minden
 Phone: +49571 887-0 | Fax: +49571 887-169
 Email: info.de@wago.com | Web: www.wago.com

Do you have any questions about our products?
 We are always happy to take your call at +49 (571) 887-44222.

Commercial data



Product Group	1 (Rail Mounted Terminal Blocks)
eCl@ss 10.0	27-14-11-20
eCl@ss 9.0	27-14-11-20
ETIM 8.0	EC000897
ETIM 7.0	EC000897
PU (SPU)	20 pcs
Packaging type	box
Country of origin	CN
GTIN	4044918754224
Customs tariff number	85369010000

Environmental Product Compliance

RoHS Compliance Status	Compliant, No Exemption
------------------------	-------------------------

Approvals / Certificates

General approvals

Logo	Approval	Additional Approval Text	Certificate name
	CCA DEKRA Certification B.V.	EN 60947	NTR NL 7894
	cURus Underwriters Laboratories Inc.	UL 1059	E45172
	KEMA/KEUR DEKRA Certification B.V.	EN 60947	71- 120778

Declarations of conformity and manufacturer's declarations



Logo	Approval	Additional Approval Text	Certificate name
	EU-Declaration of Conformity WAGO GmbH & Co. KG	-	-
	UK-Declaration of Conformity	-	-

Subject to changes. Please also observe the further product documentation!

WAGO GmbH & Co. KG
 Hansastr. 27
 32423 Minden
 Phone: +49571 887-0 | Fax: +49571 887-169
 Email: info.de@wago.com | Web: www.wago.com

Do you have any questions about our products?
 We are always happy to take your call at +49 (571) 887-44222.



Approvals for marine applications

Logo	Approval	Additional Approval Text	Certificate name
	ABS American Bureau of Shipping	EN 60947	20- HG1941090- PDA
	BV Bureau Veritas S.A.	EN 60947	07436/F0 BV
	DNV GL Det Norske Veritas, Germanischer Lloyd	-	TAE00001V2

Required accessories

End plate



End plate

	Item no.: 282-390 End and separator plate; 1.5 mm thick; gray	www.wago.com/282-390
	Item no.: 282-385 End and separator plate; 1.5 mm thick; orange	www.wago.com/282-385

Optional accessories

Carrier rail





Mounting accessories

	Item no.: 210-197 Steel carrier rail; 35 x 15 mm; 1.5 mm thick; 2 m long; slotted; similar to EN 60715; silver-colored	www.wago.com/210-197
	Item no.: 210-198 Copper carrier rail; 35 x 15 mm; 2.3 mm thick; 2 m long; unslotted; according to EN 60715; copper-colored	www.wago.com/210-198
	Item no.: 210-504 Steel carrier rail; 35 x 7.5 mm; 1 mm thick; 2 m long; slotted; galvanized; according to EN 60715; silver-colored	www.wago.com/210-504

Subject to changes. Please also observe the further product documentation!

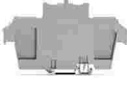
	Item no.: 210-505 Steel carrier rail; 35 x 7.5 mm; 1 mm thick; 2 m long; unslotted; galvanized; according to EN 60715; silver-colored	www.wago.com/210-505
	Item no.: 210-506 Steel carrier rail; 35 x 15 mm; 1.5 mm thick; 2 m long; unslotted; galvanized; similar to EN 60715; silver-colored	www.wago.com/210-506
	Item no.: 210-508 Steel carrier rail; 35 x 15 mm; 1.5 mm thick; 2 m long; slotted; galvanized; similar to EN 60715; silver-colored	www.wago.com/210-508
	Item no.: 210-113 Steel carrier rail; 35 x 7.5 mm; 1 mm thick; 2 m long; unslotted; according to EN 60715; silver-colored	www.wago.com/210-113
	Item no.: 210-118 Steel carrier rail; 35 x 15 mm; 2.3 mm thick; 2 m long; unslotted; according to EN 60715; silver-colored	www.wago.com/210-118
	Item no.: 210-112 Steel carrier rail; 35 x 7.5 mm; 1 mm thick; 2 m long; slotted; according to EN 60715; "Hole width 25 mm; silver-colored	www.wago.com/210-112
	Item no.: 210-114 Steel carrier rail; 35 x 15 mm; 1.5 mm thick; 2 m long; unslotted; similar to EN 60715; silver-colored	www.wago.com/210-114
	Item no.: 210-115 Steel carrier rail; 35 x 7.5 mm; 1 mm thick; 2 m long; slotted; according to EN 60715; "Hole width 18 mm; silver-colored	www.wago.com/210-115
	Item no.: 210-196 Aluminum carrier rail; 35 x 8.2 mm; 1.6 mm thick; 2 m long; unslotted; similar to EN 60715; silver-colored	www.wago.com/210-196

Mounting

Cover carrier		
	Item no.: 709-168 Cover carrier; Type 2; incl. fixing/retaining screws and knurled nut; suitable for 283 to 285 Series rail-mounted terminal blocks; suitable for 279 to 281 Series double- and triple-deck terminal blocks; suitable for 780 to 785, 775, 776 and 777 Series TOPJOB® rail-mounted terminal blocks; suitable for 280 Series sensor and actuator terminal blocks; suitable for 282 Series disconnect/test terminal blocks for transformer circuits; gray	www.wago.com/709-168
Cover		
	Item no.: 709-154 Cover; Type 2; suitable for cover carrier, type 2; 1 m long; transparent	www.wago.com/709-154
Mounting accessories		
	Item no.: 209-106 Mounting carrier; for isolated mounting on DIN 35 rails; gray	www.wago.com/209-106
	Item no.: 249-116 Screwless end stop; 6 mm wide; for DIN-rail 35 x 15 and 35 x 7.5; gray	www.wago.com/249-116

Subject to changes. Please also observe the further product documentation!

Tool

Operating tool

**Item no.: 210-721**

Operating tool; Blade: 5.5 x 0.8 mm; with a partially insulated shaft; multicoloured

www.wago.com/210-721

Protective warning marker

Cover

**Item no.: 282-415**

Protective warning marker; for 5 terminal blocks; with high-voltage symbol, black; yellow

www.wago.com/282-415

Testing and measuring

Testing accessories

**Item no.: 209-170**Test plug adapter; 8.3 mm wide; for 4 mm Ø test plugs; suitable for 1.5 mm² - 10 mm² tbs; graywww.wago.com/209-170

Ferrule

Ferrule

**Item no.: 216-263**Ferrule; Sleeve for 1 mm² / AWG 18; insulated; electro-tin plated; electrolytic copper; gastight crimped; acc. to DIN 46228, Part 4/09.90; red www.wago.com/216-263**Item no.: 216-266**Ferrule; Sleeve for 2.5 mm² / AWG 14; insulated; electro-tin plated; electrolytic copper; gastight crimped; acc. to DIN 46228, Part 4/09.90; blue www.wago.com/216-266**Item no.: 216-264**Ferrule; Sleeve for 1.5 mm² / AWG 16; insulated; electro-tin plated; electrolytic copper; gastight crimped; acc. to DIN 46228, Part 4/09.90; black www.wago.com/216-264**Item no.: 216-262**Ferrule; Sleeve for 0.75 mm² / 18 AWG; insulated; electro-tin plated; electrolytic copper; gastight crimped; acc. to DIN 46228, Part 4/09.90; gray www.wago.com/216-262**Item no.: 216-267**Ferrule; Sleeve for 4 mm² / AWG 12; insulated; electro-tin plated; electrolytic copper; gastight crimped; acc. to DIN 46228, Part 4/09.90; gray www.wago.com/216-267

Marking accessories

Marker

**Item no.: 2009-115/000-002**

WMB-Inline; for Smart Printer; 1500 pieces on roll; stretchable 5 - 5.2 mm; plain; snap-on type; yellow

www.wago.com/2009-115/000-002**Item no.: 2009-115/000-007**

WMB-Inline; for Smart Printer; 1500 pieces on roll; stretchable 5 - 5.2 mm; plain; snap-on type; gray

www.wago.com/2009-115/000-007**Item no.: 2009-115/000-017**WMB-Inline; for Smart Printer; 1500 pieces on roll; stretchable 5 - 5.2 mm; plain; snap-on type; light green www.wago.com/2009-115/000-017

Subject to changes. Please also observe the further product documentation!

WAGO GmbH & Co. KG

Hansastr. 27











32423 Minden

Phone: +49571 887-0 | Fax: +49571 887-169

Email: info.de@wago.com | Web: www.wago.com

Do you have any questions about our products?

We are always happy to take your call at +49 (571) 887-44222.

	Item no.: 2009-115/000-023 WMB-Inline; for Smart Printer; 1500 pieces on roll; stretchable 5 - 5.2 mm; plain; snap-on type; green	www.wago.com/2009-115/000-023
	Item no.: 2009-115/000-024 WMB-Inline; for Smart Printer; 1500 pieces on roll; stretchable 5 - 5.2 mm; plain; snap-on type; violet	www.wago.com/2009-115/000-024
	Item no.: 2009-115 WMB-Inline; for Smart Printer; 1500 pieces on roll; stretchable 5 - 5.2 mm; plain; snap-on type; white	www.wago.com/2009-115
	Item no.: 793-5501/000-007 WMB marking card; as card; for terminal block width 5 - 17.5 mm; stretchable 5 - 5.2 mm; plain; snap-on type; gray	www.wago.com/793-5501/000-007
	Item no.: 793-5501/000-012 WMB marking card; as card; for terminal block width 5 - 17.5 mm; stretchable 5 - 5.2 mm; plain; snap-on type; orange	www.wago.com/793-5501/000-012
	Item no.: 793-5501/000-014 WMB marking card; as card; for terminal block width 5 - 17.5 mm; stretchable 5 - 5.2 mm; plain; snap-on type; brown	www.wago.com/793-5501/000-014
	Item no.: 793-5501/000-017 WMB marking card; as card; for terminal block width 5 - 17.5 mm; stretchable 5 - 5.2 mm; plain; snap-on type; light green	www.wago.com/793-5501/000-017
	Item no.: 793-5501/000-023 WMB marking card; as card; for terminal block width 5 - 17.5 mm; stretchable 5 - 5.2 mm; plain; snap-on type; green	www.wago.com/793-5501/000-023
	Item no.: 793-5501/000-024 WMB marking card; as card; for terminal block width 5 - 17.5 mm; stretchable 5 - 5.2 mm; plain; snap-on type; violet	www.wago.com/793-5501/000-024
	Item no.: 793-501/000-002 WMB marking card; as card; not stretchable; plain; snap-on type; yellow	www.wago.com/793-501/000-002
	Item no.: 793-501/000-007 WMB marking card; as card; not stretchable; plain; snap-on type; gray	www.wago.com/793-501/000-007

Subject to changes. Please also observe the further product documentation!



Item no.: 793-501/000-017

WMB marking card; as card; not stretchable; plain; snap-on type; light green

www.wago.com/793-501/000-017



Item no.: 793-501/000-012

WMB marking card; as card; not stretchable; plain; snap-on type; orange

www.wago.com/793-501/000-012



Item no.: 793-501/000-023

WMB marking card; as card; not stretchable; plain; snap-on type; green

www.wago.com/793-501/000-023



Item no.: 793-501/000-006

WMB marking card; as card; not stretchable; plain; snap-on type; blue

www.wago.com/793-501/000-006



Item no.: 793-501/000-005

WMB marking card; as card; not stretchable; plain; snap-on type; red

www.wago.com/793-501/000-005



Item no.: 793-501

WMB marking card; as card; not stretchable; plain; snap-on type; white

www.wago.com/793-501



Item no.: 793-501/000-024

WMB marking card; as card; not stretchable; plain; snap-on type; violet

www.wago.com/793-501/000-024



Item no.: 794-5553/000-002

WMB marking card; as card; MARKED; k/l (each 50); stretchable 5 - 5.2 mm; Horizontal marking; snap-on type; yellow

www.wago.com/794-5553/000-002



Item no.: 793-5501/000-005

WMB marking card; as card; for terminal block width 5 - 17.5 mm; stretchable 5 - 5.2 mm; plain; snap-on type; red

www.wago.com/793-5501/000-005



Item no.: 793-5501/000-002

WMB marking card; as card; for terminal block width 5 - 17.5 mm; stretchable 5 - 5.2 mm; plain; snap-on type; yellow

www.wago.com/793-5501/000-002



Item no.: 793-5501/000-006

WMB marking card; as card; for terminal block width 5 - 17.5 mm; stretchable 5 - 5.2 mm; plain; snap-on type; blue

www.wago.com/793-5501/000-006

Item no.: 793-5501

Subject to changes. Please also observe the further product documentation!

WAGO GmbH & Co. KG

Hansastr. 27

32423 Minden

Phone: +49571 887-0 | Fax: +49571 887-169

Email: info.de@wago.com | Web: www.wago.com

Do you have any questions about our products?

We are always happy to take your call at +49 (571) 887-44222.



WMB marking card; as card; for terminal block width 5 - 17.5 mm; stretchable 5 - 5.2 mm; plain; snap-on type; white www.wago.com/793-5501



Item no.: 2009-115/000-012 www.wago.com/2009-115/000-012
WMB-Inline; for Smart Printer; 1500 pieces on roll; stretchable 5 - 5.2 mm; plain; snap-on type; orange



Item no.: 2009-115/000-006 www.wago.com/2009-115/000-006
WMB-Inline; for Smart Printer; 1500 pieces on roll; stretchable 5 - 5.2 mm; plain; snap-on type; blue

Group marker carrier



Item no.: 209-144 www.wago.com/209-144
Group marker carrier; gray



Item no.: 209-143 www.wago.com/209-143
Group marker carrier; gray



Item no.: 249-105 www.wago.com/249-105
Group marker carrier; gray

Jumpers

Jumper



Item no.: 282-409 www.wago.com/282-409
Jumper; insulated; gray



Item no.: 282-402 www.wago.com/282-402
Jumper; insulated; gray



Item no.: 282-422 www.wago.com/282-422
Jumper; insulated; yellow-green



Item no.: 709-110 www.wago.com/709-110
Wire commoning chain; 2.5 mm²; insulated; black



Item no.: 709-112 www.wago.com/709-112
Wire commoning chain; 2.5 mm²; insulated; black



Item no.: 709-111 www.wago.com/709-111
Wire commoning chain; 2.5 mm²; insulated; black

Downloads

Documentation

Bid Text

282-865	2019 Feb 19	xml	Download
---------	-------------	-----	----------

Subject to changes. Please also observe the further product documentation!



X81 - Datei			3.4 kB	
282-865 doc - Datei	2017 Mar 2	doc	25.1 kB	Download

Additional Information

Technical Section		pdf		Download
Technical explanations		2.2 MB		

CAD/CAE-Data

CAD data

2D/3D Models 282-865		URL		Download
----------------------	--	-----	--	----------

CAE data

EPLAN Data Portal 282-865		URL		Download
---------------------------	--	-----	--	----------

WSCAD Universe 282-865		URL		Download
------------------------	--	-----	--	----------

ZUKEN Portal 282-865		URL		Download
----------------------	--	-----	--	----------

Environmental Product Compliance

Compliance Search

Environmental Product Compliance 282-865 3-conductor through terminal block; 6 mm ² ; with touch-proof test socket; e.g., current transformer circuits; center marking; for DIN-rail 35 x 15 and 35 x 7.5; CAGE CLAMP®; 6,00 mm ² ; gray		URL		Download
---	--	-----	--	----------

Installation Notes

Conductor termination

Subject to changes. Please also observe the further product documentation!

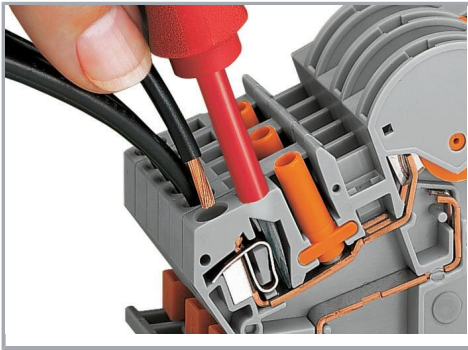

CAGE CLAMP® connection

Inserting a conductor via operating tool (5.5 x 0.8 mm blade).



Additional CAGE CLAMP® connection on the measurement device side, e.g., when connecting wire commoning chains or applying an external voltage.

Commoning

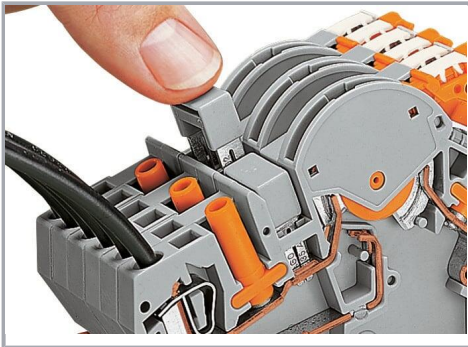

Additional commoning possible with circuit-related adjacent jumpers or testing option via test plug adapter (209-170) on transformer side.

Testing

Subject to changes. Please also observe the further product documentation!

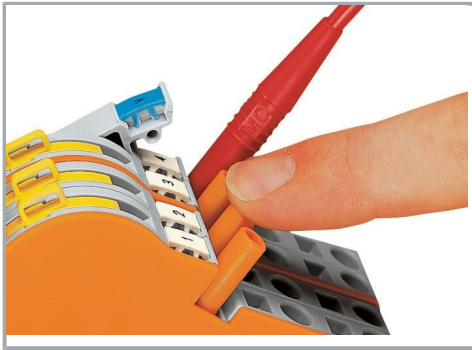

Touch-proof test sockets for touch-proof 4 mm Ø test plugs (not available from WAGO, but are offered by industry suppliers such as, Fabrikat Multi-Contact)

Marking

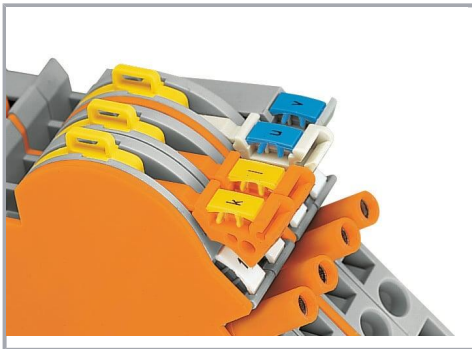

Labeling via WMB Multi Marking System.

Subject to changes. Please also observe the further product documentation!