

Mechanical Dimensions: Inches [mm]

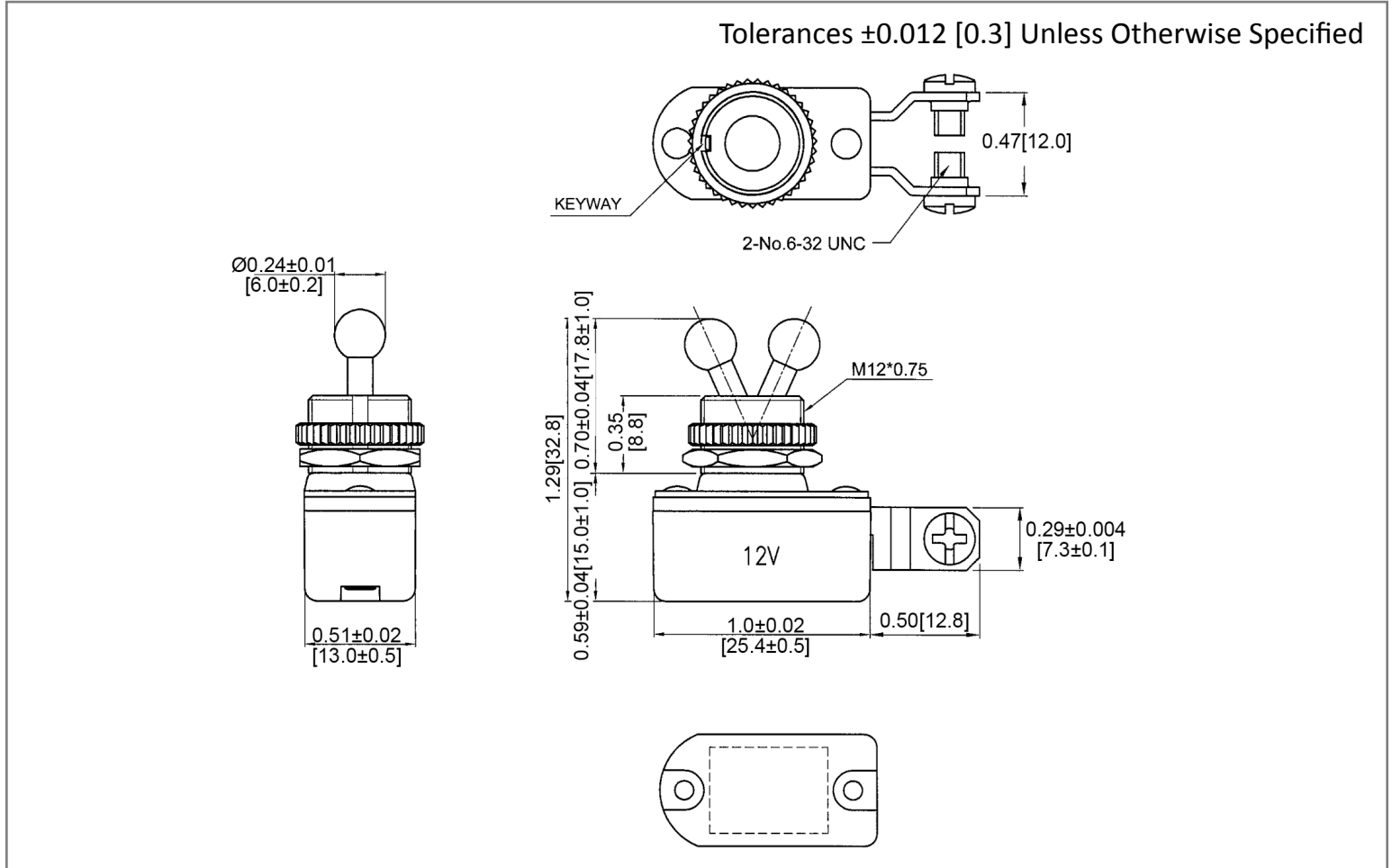

Mounting Hole

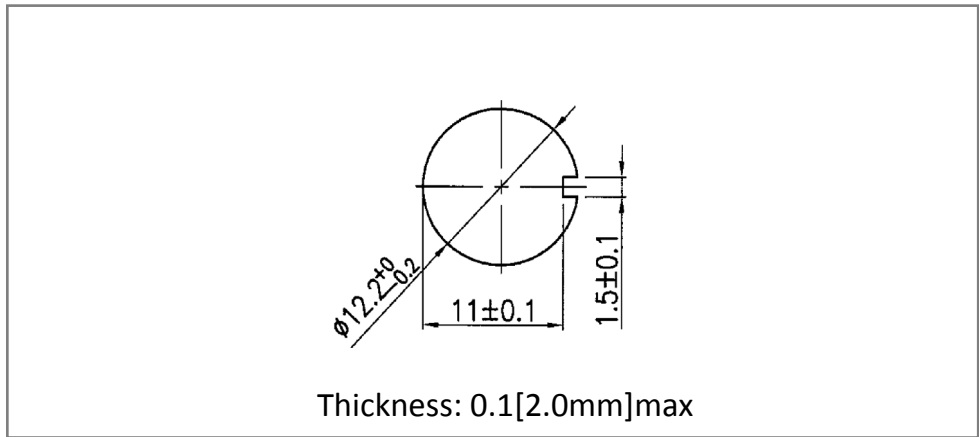

Circuit Diagram

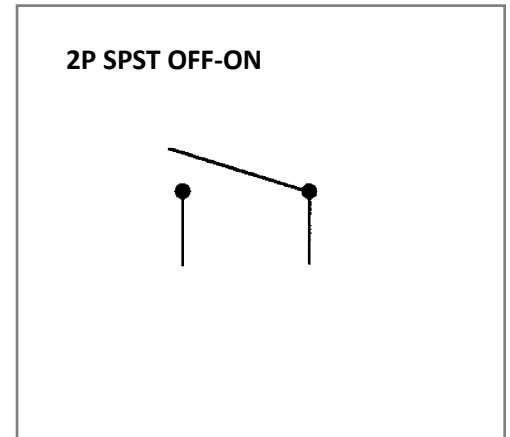

Electrical Specifications

Rating	6A 125V AC, 3A 250V AC
Contact Resistance	50m ohm Max
Insulation Resistance	DC 500V 100M ohm Min
Dielectric Strength	AC 1500V 1 minute

Material Specifications

1 Hex Nut Assy
1 Knurl Nut Assy

Rev Date of issue Revision Notes

Designed Approved

B	11-30-2021	Initial Drawing	RC	OF
---	------------	-----------------	----	----