

cannon

CGL Connectors



ITT



ITT Corporation

ITT is a diversified leading manufacturer of highly engineered critical components and customized technology solutions for the energy, transportation and industrial markets. Building on its heritage of innovation, ITT partners with its customers to deliver enduring solutions to the key industries that underpin our modern way of life. Founded in 1920, ITT is headquartered in White Plains, N.Y., with employees in more than 35 countries and sales in a total of approximately 125 countries. For more information, visit www.itt.com.

Our connector portfolio remains the most extensive in the industry, offering a reliable and cost effective range of interconnect solutions with the brands of Cannon, VEAM and BIW Connector Systems. Continuous investment in technology and research & development have enabled ITT to provide new, innovative products and solutions to markets including:



Transportation



Industrial / Instrumentation



Oil & Gas



Defense Vehicles



Commercial & Military Aerospace



Automotive



Computer, Telecom & Consumer Electronics

Our connector portfolio remains the most extensive in the industry, offering a reliable and cost effective range of interconnect solutions

Introduction to CGL

Circular connectors featured by metal shells are usually only good for an operating voltage of 50 Volts. Voltages in excess to that are considered to be potentially hazardous for any human body. ITT Cannon already in 1987 took appropriate measures to develop the essential design features to respond to this fact.

There was an increasing need for connectors of such nature seen in industrial applications like motors and drives and numerous other options wherever goods or things have to be moved. Usually such applications are featured by the utilization of mains power which often has to be connected.

Features and benefits

- The products in this catalogue are designed to be utilized with mains power which means 250–700 V_{RMS} depending on the insulator style and the contact arrangement.
- All the plugs and receptacles equipped with a first to mate last to break grounding contact are electrically linked to the shell.
- There are various backshell or adapter options available like PG and metric gland adapters. As there are hundreds of PG and metric gland versions on the market available we would like our valued customers to purchase these parts separately.
- The Universal Endbell is an ITT Cannon development which offers a shielding option and sealing up to IP69k.
- The 700V products are coined by a UL certification.

Contact us for detail or your request for a customized solution.

Table of contents

How to use this catalogue..... 6

CGL 250V–500V versions

Product overview 7

Ordering reference 9

Contact arrangements..... 10

Box mounting receptacle CGL02..... 12

Straight plug CGL06..... 13

90° plug CGL08 14

Connectors with Universal Endbells 15

300V special versions..... 16

Accessories 18

Tooling..... 20

CGL 700V special versions

Product overview 21

Contact arrangements..... 22

Size 28..... 23

Size 36..... 24

Tooling..... 25

Product safety information 26

How to use

This catalog is split in several sections that help you to

- get a general overview of all product lines (product overview)
- get all required detail information (dimensions, product details)
- get all required support products (accessories, tooling)

The fastest way to find your product of choice is to follow these steps

First section: CGL 250V-500V (see page 7-20)

1 **Select your product** using the "ordering reference"

3 **Add accessories and tooling** as required on the related pages

2 **Use the detail pages** to better understand the available options and choose the best solution for your needs

4 **Use the contact information** on the back cover to contact us for further questions or to get advise on where you can purchase our products

Second section: CGL 700V special versions (see page 21-25)

1 **Select your product** using the "contact arrangement" on page 22

3 **Add contacts** from the contact tables **and tooling** as required on the related pages

2 **Use the detail pages** to better understand the available options and choose the best solution for your needs

4 **Use the contact information** on the back cover to contact us for further questions or to get advise on where you can purchase our products

Product overview CGL 250V–500V

ELECTRICAL DATA

Contact rating at 20°C (68°F)

Contact size (AWG/metric)	Rated Current (A _{max.})
16S/15S	22
16/15	22
12	41
8/60/100	74
4/160	135

For air and creepage paths, test and operating voltage see page 10-11

Current rating

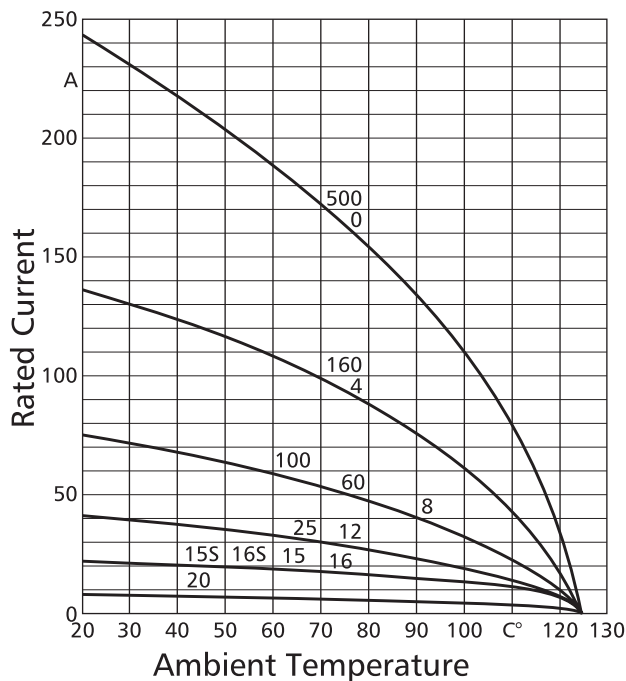

Contacts resistance

The contact resistance has to be tested acc. to VG95319 part 2, Test no 5.10.1

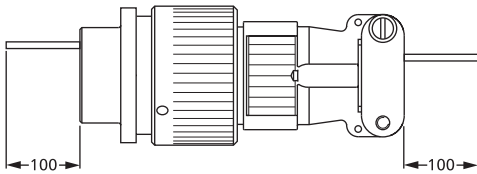

Contact size		Contact resistance
metric	AWG	mΩ max.
15S/15	16S/16	6,0
25	12	3,0
60/100	8	1,0
160	4	0,3

MECHANICAL FEATURES

Ambient temperature

–55/125°C (–67/257°F)

Safety provisions

Bayonet coupling: IP 68 acc. to ISO 20653 (1 bar pressure within 16 hours)

Threaded coupling: IP65 acc. to ISO 20653

Vibration test

200m/s² at 10–2000Hz

Mating cycles

min. 500

Separating force per contact

The separating force has to be measured acc. to VG 95319 part 2, test no 5.7. using the required test gage.

Contact size		Separating force	
metric	AWG	N min	Gage
15S/15	16S/16	1,0	G 1,56
25	12	1,5	G 2,36
60/100	8	3,0	G 3,58
160	4	4,0	G 5,69

Gage see also VG95234 Part 1

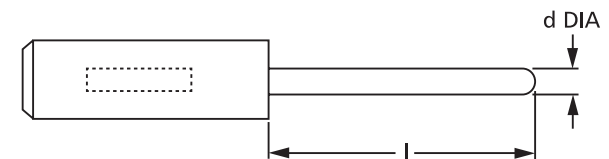

Gage	d DIA	l
	+0,01	–1
G 1,56	1,56	9
G 2,36	2,36	12
G 3,58	3,58	13
G 5,69	5,69	13

Contact retention

The contact retention has to be tested acc. to VG95319 part 2, Test no 5.4. Apply test force in mating direction

Contact size		Test force
metric	AWG	N
15S/15	16S/16	35
25	12	55
60/100	8	80
160	4	90

Product overview CGL 250V–500V

MECHANICAL FEATURES (continued)

Separating and mating force

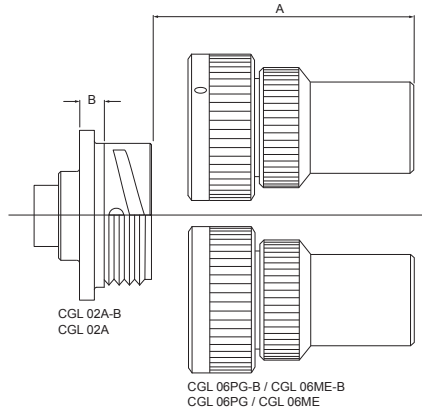

Shell size	A	B
	min.	max
18	90	7,2
20	100	7,2
22	100	8,0
24	110	9,5
28	110	9,5

MECHANICAL FEATURES (continued)

Mounting dimension

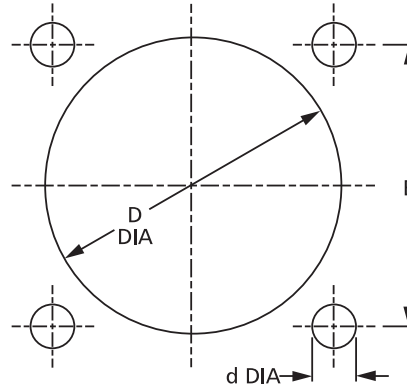

Mounting holes for box mounting connectors, Style CGL02/CGL02-B

Shell size	CGL02		CGL02-B		CGL02/CGL02-B
	ØD H12	ØD H13	ØD H12	ØD H13	E±0,1
18	28,7	3,1	31,1	3,2	27,0
20	31,8	3,1	34,5	3,2	29,4
22	35,0	3,1	37,8	3,2	31,8
24	38,2	3,7	41,3	3,7	34,9
28	44,5	3,7	47,1	3,7	39,7

Coupling torques

The allowable coupling torques have to be tested under full bundle conditions of the connectors acc. to VG95319 part 2, Test no. 5.8.2.

Shell size	Allowable coupling torque Nm	
	Closing and opening CGL-B max.	Opening CGL/CGL-B min.
18	8,0	0,58
20	9,0	0,70
22	11,0	0,80
24	14,0	0,80
28	17,0	0,92

Ordering reference

Part number explanation

CGL 08 IN 28 A16 PD1L- B- F80 D14 ***

Series		
Shell type		
02 – box mounting receptacle with square flange	see page 12	
06 – straight plug	see page 13	
08 – plug with 90° adapter	see page 14	
Class		
IN – Universal Endbell (nickel plated)		
PG – with PG adapter (nickel plated)		
ME – with metric adapter (nickel plated)		
A – without endbell (style 02 only)		
Shell size		
18, 20, 22, 24, 28		
Contact arrangement	see page 10–11	
Contact type		
P – pin		
S – socket		
Performance class		
A1, C1, D1 – dependent on layout, see page 10		
Insulator type		
L – long insulator = 250V/500V		
Bayonet coupling (for threaded version: omit indication)		
Contacts*		
F80 – crimp contacts		
Outer cable diameter (Universal Endbell only)		
Modification		
F0 – without contacts		
F42 – without endbell		

*Crimp contacts are solderable

CONTACT ARRANGEMENTS

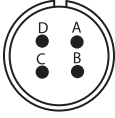
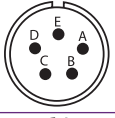
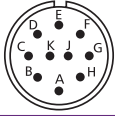
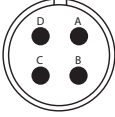
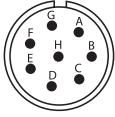
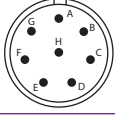
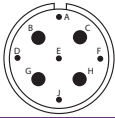
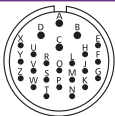
Shell size	Figure	Contact arrangement	Contact number Contact size	Grounding contact in cavity	Admissible operating voltage (VAC)	Examples of available connectors
18		18-10	4 12	D	500	CGL02A18-10P-D1L-*** CGL02A18-10S-D1L-*** CGL06PG18-10P-D1L-*** CGL06PG18-10S-D1L-*** CGL08PG18-10S-D1L-*** CGL06IN18-10S-D1L-***
		18-11	5 12	C	500	CGL02A18-11P-C1L-*** CGL06PG18-11S-C1L-*** CGL08PG18-11S-C1L-***
20		20G10	10 10x16	A	400	CGL02A20G10P-A1L-*** CGL02A20G10S-A1L-*** CGL06PG20G10P-A1L-*** CGL06PG20G10S-A1L-***
22		22-22	4 8	D	500	CGL02A22-22P-D1L-*** CGL02A22-22S-D1L-*** CGL06PG22-22P-D1L-*** CGL06PG22-22S-D1L-*** CGL08PG22-22S-D1L-***
		22-23	8 12	D	400	CGL02A22-23P-D1L-*** CGL02A22-23S-D1L-*** CGL06PG22-23P-D1L-*** CGL06PG22-23S-D1L-*** CGL08PG22-23S-D1L-***
24		24G8*	8 12	A	400	CGL02AH24G8P-A1L-*** CGL02AH24G8S-A1L-*** CGL06PGH24G28P-A1L-*** CGL06PGH24G28S-A1L-***
28		28A16	9 4x4 5x36	D	400	CGL02A28A16P-D1L-*** CGL02A28A16S-D1L-*** CGL06PG28A16P-D1L-*** CGL06PG28A16S-D1L-***
		28G24*	24 4x12 20x16	A	500	CGL02AH28G24P-A1L-*** CGL02AH28G24S-A1L-*** CGL06PGH28G24P-A1L-*** CGL06PGH28G24S-A1L-***

*The insulator material is FKM.

***Modification codes please see ordering reference, page 9

CONTACT ARRANGEMENTS

LAYOUT SPECIFIC DATA

Contact arrangement	Min. air distance (mm) / mating face				Rated Voltage
	Power-Contact	Power-Grounding	Signal-Contact	Signal-Grounding	Class
18-10	5,0	5,0	–	–	500 V
18-11	5,0	5,0	–	–	500 V
20G10	4,3	4,0	–	–	400 V
22-22	6,1	5,4	–	–	500 V
22-23	4,3	4,0	–	–	400 V
24G8	5,9	4,0	–	–	400 V
28A16	8,0	4,6	6,1	5,0	400 V
28G24	7,5	5,6	3,4	2,7	500 V

Contact arrangement	Min. creepage distance (mm) / mating face				Rated Voltage
	Power-Contact	Power-Grounding	Signal-Contact	Signal-Grounding	Class
18-10	5,0	5,0	–	–	500 V
18-11	5,0	5,0	–	–	500 V
20G10	4,3	4,3	–	–	400 V
22-22	6,1	6,1	–	–	500 V
22-23	4,3	4,3	–	–	400 V
24G8	5,9	4,0	–	–	400 V
28A16	8,0	4,6	6,1	5,0	400 V
28G24	7,5	5,6	3,4	2,7	500 V

Admissible operating voltage

The admissible operating voltages indicated in this catalogue are mainly based on customer information for certain projects. The tables above indicate the actual value for the air and creepage distances and can be used as a calculation basis in connection with DIN EN 61984. All the plugs and receptacles equipped with a first to mate last to break grounding contact are electrically linked to the shell.

Basis and assumptions

The pollution degree for industrial plants is normally "3". However, the calculation of the admissible operating voltage is based on the pollution degree "2", as the connectors are completely sealed and the contact parts are not subject to direct contamination or humidity.

Calculation basis for rated connector impulse voltage

Overvoltage category 250/500 V III

Material class 250/500 V III

BOX MOUNTING RECEPTACLE CLASS E CGL02

CGL02A-B with bayonet coupling

CGL02-B is a box mounting receptacle for front panel mounting. It mates with plugs CGL06-B and CGL08-B

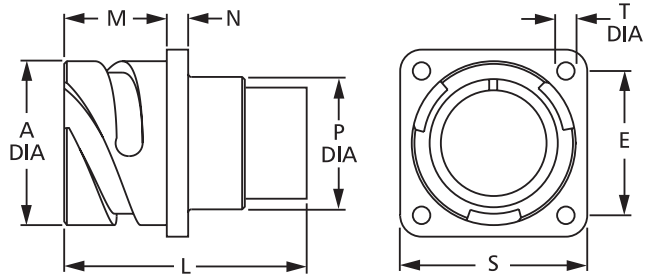

Part No. (pin insert)	Ø A	E	L	M	N	Ø P	S	Ø T
	max.	± 0,1	max.	+0,4	± 0,3	max.	± 0,3	+0,2/-0,1
CGL02A18-10P-D1L-B-F80	30,8	27,0	46,0	19,0	4,0	25,6	35,0	3,2
CGL02A18-11P-C1L-B-F80	30,8	27,0	33,8	19,0	4,0	25,6	35,0	3,2
CGL02A20G10P-A1L-B-F80	34,2	29,4	33,8	19,0	4,0	29,0	38,0	3,2
CGL02A22-22P-D1L-B-F80	37,4	31,8	46,0	19,0	4,0	32,2	41,0	3,2
CGL02A22-23P-D1L-B-F80	37,4	31,8	46,0	19,0	4,0	32,2	41,0	3,2
CGL02AH24G8P-A1L-B-F80	40,9	34,9	46,0	20,6	4,0	35,3	44,5	3,7
CGL02A28A16P-D1L-B-F80	46,7	39,7	46,0	20,6	4,0	41,4	50,8	3,7
CGL02AH28G24P-A1L-B-F80	46,7	39,7	46,0	20,6	4,0	41,4	50,8	3,7

For socket inserts substitute P with S

CGL02A with threaded coupling

CGL02A is a box mounting receptacle for front panel mounting. It mates with plugs CGL06 and CGL08

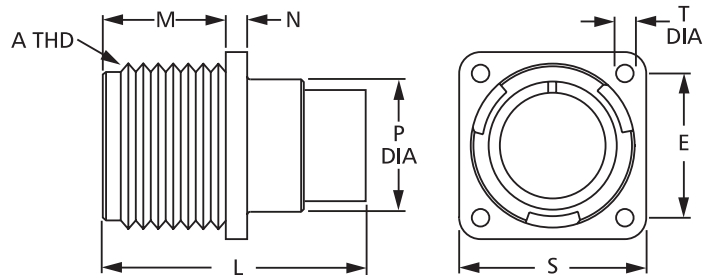
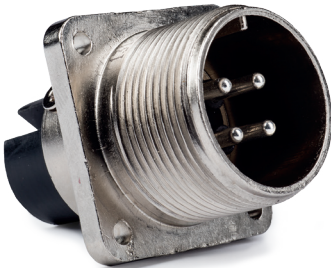

Part No. (pin insert)	A	E	L	M	N	Ø P	S	Ø T
	Thread	± 0,1	max.	+0,4	± 0,3	max.	± 0,3	+0,2/-0,1
CGL02A18-10P-D1L-F80	1-1/8-18UNEF-2A	27,0	46,0	19,0	4,0	25,4	35,0	3,1
CGL02A18-11P-C1L-F80	1-1/8-18UNEF-2A	27,0	46,0	19,0	4,0	25,4	35,0	3,1
CGL02A20G10P-A1L-F80	1-1/4-18UNEF-2A	29,4	47,0	19,0	4,0	29,0	38,0	3,1
CGL02A22-22P-D1L-F80	1-3/8-18UNEF-2A	31,8	46,0	19,0	4,0	32,2	41,0	3,1
CGL02A22-23P-D1L-F80	1-3/8-18UNEF-2A	31,8	46,0	19,0	4,0	32,2	41,0	3,1
CGL02AH24G8P-A1L-F80	1-1/2-18UNEF-2A	34,9	46,0	20,6	4,0	35,3	44,5	3,7
CGL02A28A16P-D1L-F80	1-3/4-18UNS-2A	39,7	46,0	20,6	4,0	41,2	50,8	3,7
CGL02AH28G24P-A1L-F80	1-3/4-18UNS-2A	39,7	46,0	20,6	4,0	41,2	50,8	3,7

For socket inserts substitute P with S

STRAIGHT PLUG CLASS PG CGL06

CGL06PG/ME-B with bayonet coupling

CGL06PG/ME-B designates a straight plug for the use of heat shrink boots or PG terminations (optional a metric adapter is available). It mates with receptacle CGL02A-B

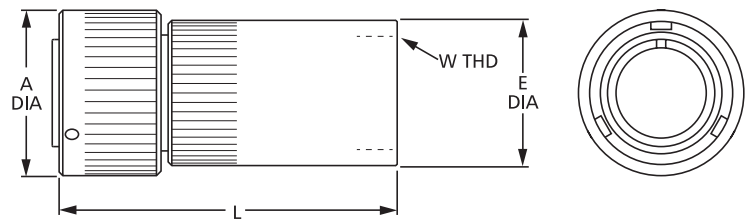

Part No. (socket insert)	Ø A	Ø E	L	W	
	max.	max.		PG Thread	ME Thread
CGL06PG18-10S-D1L-B-F80	36,5	32,0	70,0	PG21	M25x1,5
CGL06PG18-11S-C1L-B-F80	36,5	32,0	70,0	PG21	M25x1,5
CGL06PG20G10S-A1L-B-F80	39,9	32,0	77,0	PG21	M25x1,5
CGL06PG22-22S-D1L-B-F80	43,1	32,0	82,0	PG21	M32x1,5
CGL06PG22-23S-D1L-B-F80	43,1	32,0	82,0	PG21	M32x1,5
CGL06PGH24G8S-A1L-B-F80	46,6	40,0	82,0	PG28	M32x1,5
CGL06PG28A16S-D1L-B-F80	53,4	50,0	87,0	PG36	M32x1,5
CGL06PGH28G24S-A1L-B-F80	53,4	50,0	87,0	PG36	M32x1,5

For pin inserts substitute S with P For ME-adapter substitute PG with ME

CGL06PG/ME with threaded coupling

CGL06PG/ME designates a straight plug for the use of heat shrink boots or PG terminations (optional a metric adapter is available). It mates with receptacle CGL02A.

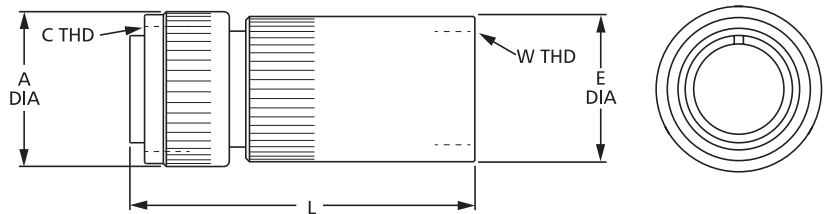

Part No. (socket insert)	Ø A	C	Ø E	L	W	
	max.	Thread	max.		max.	PG Thread
CGL06PG18-10S-D1L-F80	36,5	1-1/8-18UNEF-2B	32,0	70,0	PG21	M25x1,5
CGL06PG18-11S-C1L-F80	36,5	1-1/8-18UNEF-2B	32,0	70,0	PG21	M25x1,5
CGL06PG20G10S-A1L-F80	37,3	1-1/4-18UNEF-2B	32,0	77,0	PG21	M25x1,5
CGL06PG22-22S-D1L-F80	43,1	1-3/8-18UNEF-2B	32,0	82,0	PG21	M32x1,5
CGL06PG22-23S-D1L-F80	40,5	1-3/8-18UNEF-2B	32,0	82,0	PG21	M32x1,5
CGL06PGH24G8S-A1L-F80	43,7	1-1/2-18UNEF-2B	40,0	82,0	PG29	M32x1,5
CGL06PG28A16S-D1L-F80	50,0	1-3/4-18UNS-2B	50,0	87,0	PG36	M32x1,5
CGL06PGH28G24S-A1L-F80	50,0	1-3/4-18UNS-2B	50,0	87,0	PG36	M32x1,5

For pin inserts substitute S with P For ME-adapter substitute PG with ME

90° PLUG CLASS PG CGL08

CGL08PG-B with bayonet coupling

CGL08PG-B designates a 90° plug for the use of heat shrink boots or PG terminations. It mates with receptacle CGL02A-B (metric thread option not available)

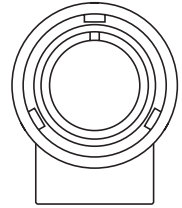
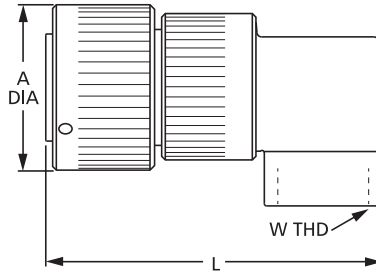

Part No. (pin Insert)	Ø A max.	L max.	W PG Thread
CGL08PG18-10P-D1L-B-F80	36,5	77,0	PG16
CGL08PG18-11P-C1L-B-F80	36,5	77,0	PG16
CGL08PG20G10P-D1L-B-F80	39,9	82,0	PG21
CGL08PG22-22P-D1L-B-F80	43,1	82,0	PG21
CGL08PG22-23P-F1L-B-F80	43,1	82,0	PG21

For socket inserts substitute P with S

CGL08PG with threaded coupling

CGL08PG designates a 90° plug for the use of heat shrink boots or PG terminations. It mates with receptacle CGL02A (metric thread option not available)

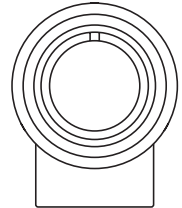
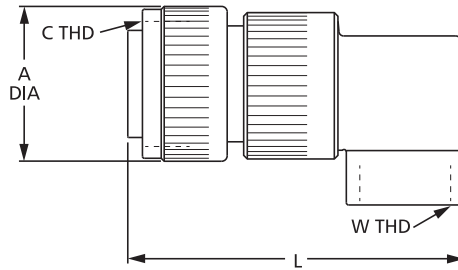

Part No. (pin Insert)	Ø A max.	C Thread	L max.	W PG Thread
CGL08PG18-10P-D1L-F80	34,1	1-1/8-18UNEF-2B	77,0	PG16
CGL08PG18-11P-C1L-F80	34,1	1-1/8-18UNEF-2B	77,0	PG16
CGL08PG20G10P-D1L-F80	37,4	1-1/4-18UNEF-2B	82,0	PG21
CGL08PG22-22P-D1L-F80	40,5	1-3/8-18UNEF-2B	82,0	PG21
CGL08PG22-23P-F1L-F80	40,5	1-3/8-18UNEF-2B	82,0	PG21

For socket inserts substitute P with S

CONNECTORS WITH UNIVERSAL ENDBELL, STRAIGHT PLUG

CGL06IN-B with bayonet coupling

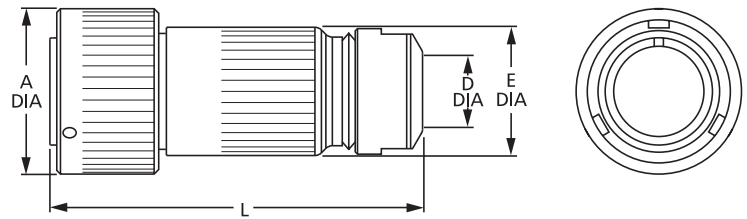
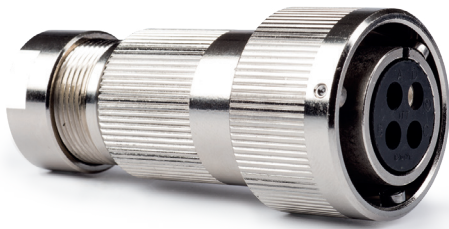

Part No. (pin Insert)	Ø A max.	Ø E ±0,2	L max.	Cable entry diameter D	Cable sealing area
CGL06IN18-10P-D1L-B-F80	36,5	30,0	88	D11 = 8,0mm–10,3mm	D11, D13, D14
CGL06IN18-11P-C1L-B-F80	36,5	30,0	88	D13 = 9,0mm–12,5mm	D11, D13, D14
CGL06IN20G10P-A1L-B-F80	39,9	33,6	92	D14 = 11,5mm–14,2mm	D13, D14, D17
CGL06IN22-22P-D1L-B-F80	43,1	33,6	98	D17 = 14,5mm–16,6mm	D14, D17, D19
CGL06IN22-23P-D1L-B-F80	43,1	33,6	98	D19 = 16,1mm–18,4mm	D14, D17, D19
CGL06IN28-A16P-D1L-B-F80	53,4	33,6	105	D20 = 17,8mm–20,0mm	D14, D17, D19, D20
CGL06INH28G24P-A1L-B-F80	53,4	33,6	105		D14, D17, D19, D20

For socket inserts substitute P with S

CGL06IN with threaded coupling

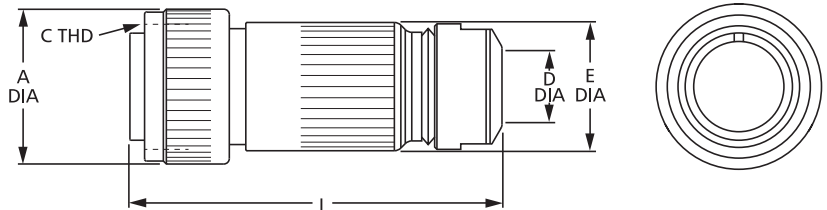

Part No. (pin Insert)	Ø A max.	Ø E ±0,2	L max.	C Thread	Cable entry diameter D	Cable sealing area
CGL06IN18-10P-D1L-F80	36,5	30,0	88,0	1-1/8-18UNEF-2B	D11 = 8,0mm–10,3mm	D11, D13, D14
CGL06IN18-11P-C1L-F80	36,5	30,0	88,0	1-1/8-18UNEF-2B	D13 = 9,0mm–12,5mm	D11, D13, D14
CGL06IN20G10P-A1L-F80	39,9	33,6	92,0	1-1/4-18UNEF-2B	D14 = 11,5mm–14,2mm	D13, D14, D17
CGL06IN22-22P-D1L-F80	43,1	33,6	98,0	1-3/8-18UNEF-2B	D17 = 14,5mm–16,6mm	D14, D17, D19
CGL06IN22-23P-D1L-F80	40,5	33,6	98,0	1-3/8-18UNEF-2B	D19 = 16,1mm–18,4mm	D14, D17, D19
CGL06IN28-A16P-D1L-F80	53,4	33,6	105,0	1-3/4-18UNS-2B	D20 = 17,8mm–20,0mm	D14, D17, D19, D20
CGL06INH28G24P-A1L-F80	53,4	33,6	105,0	1-3/4-18UNS-2B		D14, D17, D19, D20

For socket inserts substitute P with S

CONNECTORS WITH UNIVERSAL ENDBELL, 90°-VERSION

CGL08IN-B with bayonet coupling



CGL08IN with threaded coupling



For more information please contact your local ITT customer service.

STRAIGHT PLUG WITH SHORT PG GLAND ADAPTER PIN AND SOCKET CONTACTS*

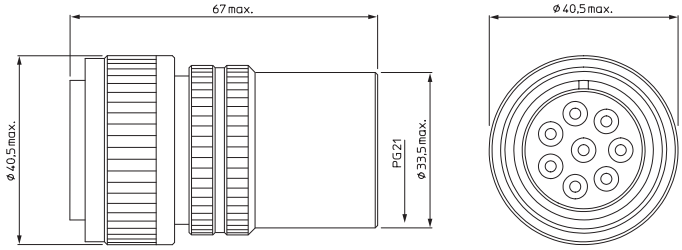

Pin contacts*		Socket contacts*	
Part number description	Ordering designation	Part number description	Ordering designation
CA06COM-E22-23P-F0-SPL	CA120001-47	CA06COM-E22-23S-F0-SPL	CA120001-48

WALL MOUNTING RECEPTACLE PIN AND SOCKET CONTACTS*

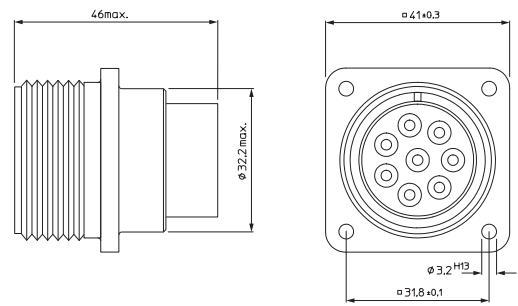
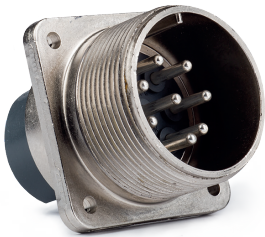

Pin contacts*		Socket contacts*	
Part number description	Ordering designation	Part number description	Ordering designation
CA02COM-E22-23P-F0-SPL	CA120001-49	CA02COM-E22-23S-F0-SPL	CA120001-50

CABLE CONNECTING PLUG WITH SHORT PG GLAND ADAPTER PIN CONTACTS*

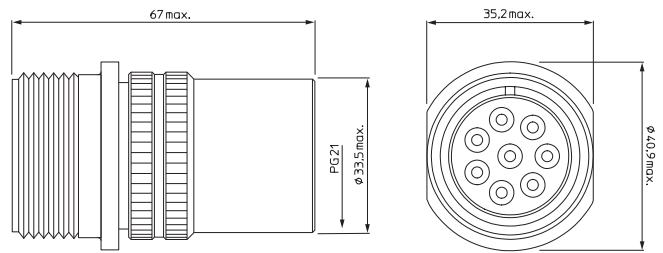

Pin contacts*		Ordering designation	
Part number description	Ordering designation		
CA01COM-E22-23P-F0-SPL	CA120001-51		

***Ordering table for contacts (Contacts to be ordered separately)**

Number of contacts permitted	Contact size	Terminal size	Socket contact crimp	Pin contact crimp	Grounding screw
7	12	0,5 ²	031-8557-040	330-8515-104	—
7	12	1,5 ²	031-8557-020	330-8515-102	—
7	12	2,5 ²	031-8557-000	330-8515-101	—
7	12	4,0 ²	031-8557-010	330-8515-103	—
7	12	6,0 ²	031-8557-030	330-8515-105	—
1	12 Ground	0,5 ²	031-8665-020	330-8723-022	250-8501-023
1	12 Ground	1,5 ²	031-8665-021	330-8723-023	250-8501-023
1	12 Ground	2,5 ²	031-8665-010	330-8723-010	250-8501-023
1	12 Ground	4,0 ²	031-8665-002	330-8723-003	250-8501-023
1	12 Ground	6,0 ²	031-8665-024	330-8723-026	250-8501-023

STRAIGHT PLUG WITH SHORT PG ADAPTER PIN AND SOCKET CONTACTS*

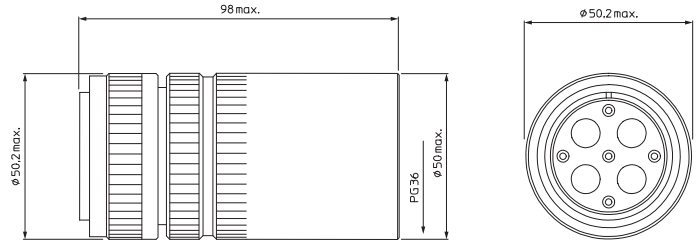

Pin contacts*		Socket contacts*	
Part number description CA06COM-E28-2009-16P-F0-SPL	Ordering designation CA120001-52	Part number description CA06COM-E28-2009-16S-F0-SPL	Ordering designation CA120001-53

WALL MOUNTING RECEPTACLE, PIN AND SOCKET CONTACTS*

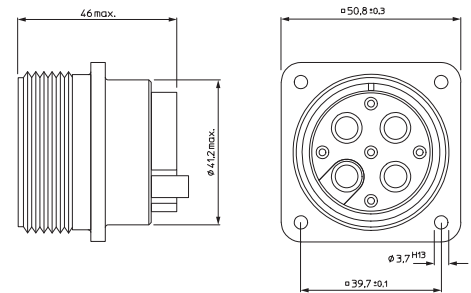
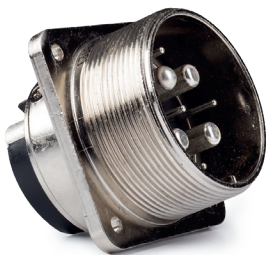

Pin contacts*		Socket contacts*	
Part number description CA02COM-E28-16S-2009-F0-SPL	Ordering designation CA120001-54	Part number description CA02COM-E28-16S-2009-F0-SPL	Ordering designation CA120001-55

CABLE CONNECTING PLUG WITH SHORT PG GLAND ADAPTER PIN CONTACTS*

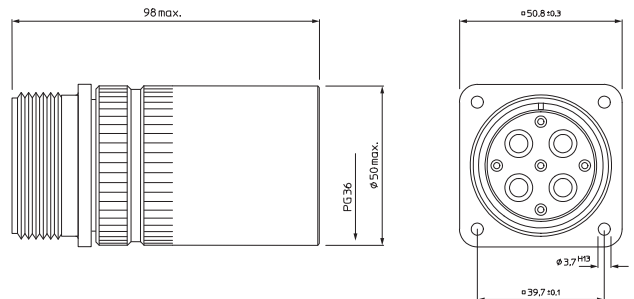
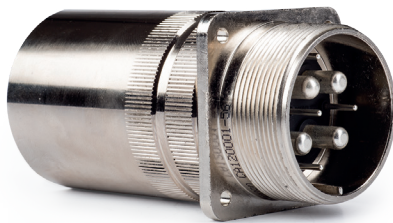

Pin contacts*		Socket contacts*	
Part number description CA00COM-E28-2009-16P-F0-SPL	Ordering designation CA120001-56		

***Ordering table for contacts (Contacts to be ordered separately)**

Number of contacts permitted	Contact size	Terminal size	Socket contact crimp	Pin contact crimp	Grounding screw
5	16	0,5 ²	031-8639-120	330-8659-000	—
5	16	1,5 ²	031-8556-110	030-8587-000	—
3	4	10,0 ²	031-8560-020	030-8658-010	—
3	4	16,0 ²	031-8560-000	030-8658-020	—
1	4 Ground	10,0 ²	031-8502-002	030-8593-002	250-8501-023
1	4 Ground	16,0 ²	031-8502-003	030-8593-003	250-8501-023

ACCESSORIES

PROTECTIVE CAPS for receptacles with bayonet coupling

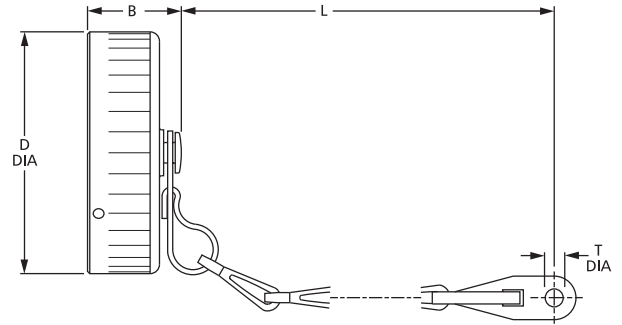

Part No.	Shell size	B	Ø D	L	Ø T
		max.	max.	±10	+0,5
CA121003-706	18	24,5	36,7	113	4,3
CA121003-707	20	24,5	40,1	127	4,3
CA121003-708	22	24,5	43,3	127	4,3
CA121003-709	24	24,5	46,8	127	4,3
CA121003-710	28	24,5	52,6	169	5,5

PROTECTIVE CAPS for receptacles with threaded coupling

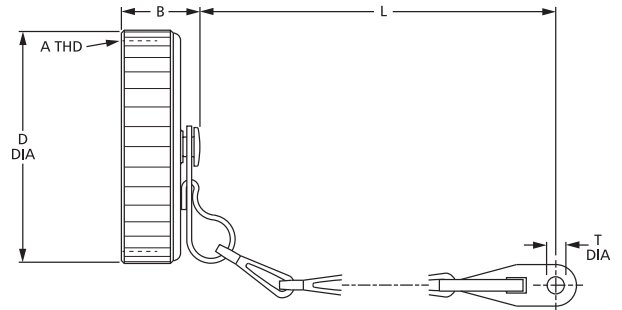

Part No.	Shell size	A	B	L	Ø T	Ø D
		Thread	max.	max.	+0,4	max.
CA121003-606	18	1-1/8-20UNEF-2B	11,7	120	3,4	32,9
CA121003-607	20	1-1/4-18UNEF-2B	11,7	134	3,4	36,1
CA121003-608	22	1-3/8-18UNEF-2B	11,7	134	3,4	39,4
CA121003-609	24	1-1/2-18UNEF-2B	11,7	147	4,2	42,6
CA121003-610	28	1-3/4-18UNS-2B	13,3	200	4,2	48,9

ACCESSORIES

PROTECTIVE CAPS for plugs with bayonet coupling

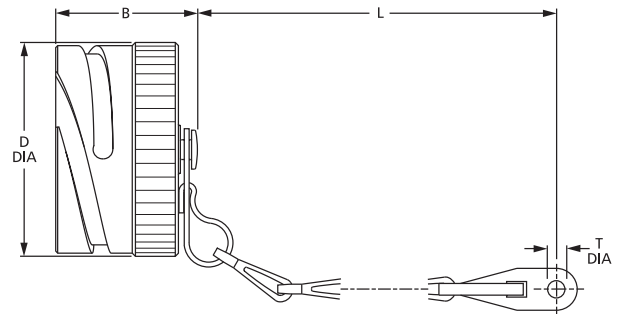

Part No.	Shell size	B	Ø D	L	Ø T
		max.	max.	±10	+0,5
CA121004-706	18	37,0	33,3	127	4,3
CA121004-707	20	37,0	36,7	140	4,7
CA121004-708	22	37,0	39,9	140	4,7
CA121004-709	24	37,0	43,4	140	4,7
CA121004-710	28	37,0	49,2	197	4,7

PROTECTIVE CAPS for plugs with threaded coupling

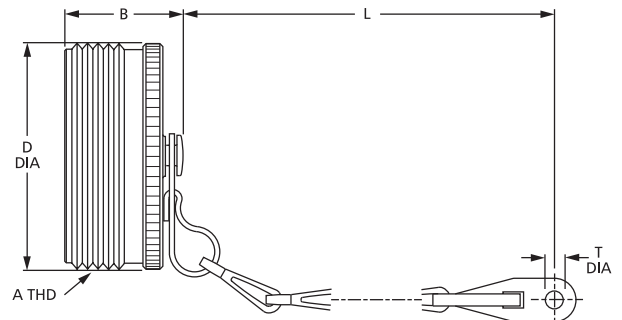

Part No.	Shell size	A	B	L	Ø T	Ø D
		Thread	max	max	+0,4	max.
CA121004-606	18	1-1/8-18UNEF-2A	25,0	29,4	120	4
CA121004-607	20	1-1/4-18UNEF-2A	25,0	32,5	134	4,8
CA121004-608	22	1-3/8-18UNEF-2A	25,0	35,7	134	4,8
CA121004-609	24	1-1/2-18UNEF-2A	25,0	38,9	147	4,8
CA121004-610	28	1-3/4-18UNS-2A	25,0	45,2	207	4,8

TOOLING

HYDRAULIC HAND CRIMPING TOOL HPW400U-ITT

for crimping contacts of size 60/100/8, 160/4 and 500/0.
Order No. 121586-5257



CRIMP DIES

Contact size	Crimp dies for hydraulic tool	Wrench Size	Locator
60/100/8	CT 121586-5231	5,20	CT 121586-5232
160/4	CT 121586-5230	7,25	

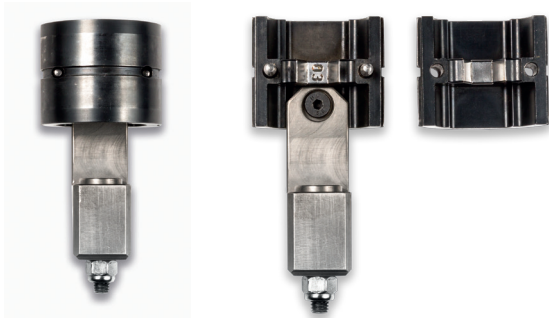

HAND CRIMPING TOOL M22520-1/01 for contacts 0,75–6,0 mm²
Order No. 995-0001-585



CRIMP LOCATOR TH452*

Order No. 995-0002-052

HAND CRIMPING TOOL CCT-CGF-E for ground contacts 0,75–6,0 mm²
Order No. 121086-3330



*modified locators are available for connectors shown on page 16–17. Please contact factory!

INSERTION TOOLS

Description	Name	Order No. ref.
Insertion tool for contact size #16	16CIT-1612	121086-3008
Insertion pliers for contact size #16	CIT-F80-16	121086-0097
Insertion tool for contact size #12	CIT-12	121086-3007
Insertion pliers for contact size #12	CIT-F80-12	121086-0096
Insertion tool for contact size #8	CIT-8	121086-0095
Insertion tool for contact size #4	CIT-4	121086-0094
Guide pin #12		27977-12T8
Guide pin #16		27977-16T50
Extraction tool for #16	CET-F80-16	121086-0081
Extraction tool #12	CET-F80-12	121086-0080
Extraction tool #8	CET-8	121086-0079
Extraction tool #4	CET-4	121086-0078



Product overview CGL 700 V

700V POWER INPUT CONNECTOR

Specification	CGL #II (28-11)	CGL #III (36-11)
Electrical conditions		
Operating voltage	700V (DC)	700 V (DC)
Insulation category (DIN/VDE 0110)	II	II
Degree of pollution (DIN/VDE 0110)	3	3
Rated insulation voltage (DIN/VDE 0110)	7,2 KV	7,2 KV
Insulation resistance	20–80 TΩ (Tera=10 ¹²)	20–80 TΩ (Tera=10 ¹²)
Temperature range		
	–50/140°C	–50/140°C
Current rating		
Power contacts	41 A	100 A
Signal contacts	22 A	22 A
Mating cycles		
	500 min.	500 min.
Degree of protection by enclosures		
ISO 20653	IP67 (mated condition)	IP67 (mated condition)
Contact arrangement/Plating/Termination		
Number of contacts	3 Power, 1 Ground, 7 Signal	3 Power, 1 Ground, 7 Signal
Contact plating	Silver	Silver
Wire size	Crimp 2,5/4/6 mm ²	Crimp 6/10/16/25 mm ²
Grounding (pin first to mate last to break)	Crimp 2,5/4/6 mm ²	Crimp 6/10/16/25 mm ²
Signal contacts	Crimp 1,5 mm ²	Crimp 1,5 mm ²
Receptacle housing and straight plug		
Coupling system	Bayonet	Bayonet
Plating	Nickel	Nickel
Polarization	5 key way	5 key way
Material	Aluminium alloy	Aluminium alloy
Available types		
	see pages 23	see pages 24
Insulator		
Material	Plastic (UL94-V0)	Plastic (UL94-V0)
Design	Fully insulated pin contact for increased creepage distance	Fully insulated pin contact for increased creepage distance
Contact insertion extraction principle	Rear release	Rear release
Sealing gaskets		
Material	Fluor elastomere	Fluor elastomere

CONTACT ARRANGEMENTS

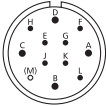
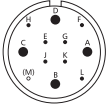
Shell size	Figure	Contact arrangement	Contact number Contact size	Grounding contact in cavity	Admissible operating voltage (VAC)	Available connectors
28		28-11	11 4x12 7x16	D	700	CGL66PG28-11P-E1D-B-F0-SPL CGL66PG28-11S-E1D-B-F0-SPL CGL61PG28-11P-E1D-B-F0-SPL CGL62A28-11P-E1D-B-F0-SPL CGL62A28-11S-E1D-B-F0-SPL
36		36-11	11 4x4 7x16	D	700	CGL66PG36-11S-E1D-B-F0-SPL CGL61PG36-11P-E1D-B-F0-SPL CGL62A36-11P-E1D-B-F0-SPL CGL66PG36-11P-E1D-B-F0-SPL CGL62A36-11S-E1D-B-F0-SPL

LAYOUT SPECIFIC DATA

Contact arrangement	Min. air distance (mm)/mating face		Min. creepage distance (mm)/mating face		Rated Voltage
	Power-Contact	Power-Grounding	Power-Power	Power-Grounding	Class
28-11	19,7	12,5	19,7	12,5	700V
36-11	10,3	10,3	10,3	10,3	700V

Admissible operating voltage

The admissible operating voltages indicated in this catalogue are mainly based on customer information for certain projects. The table above indicates the actual value for the air and creepage paths and can be used as a calculation basis in connection with DIN EN 61984. All the plugs and receptacles equipped with a first to mate last to break grounding contact are electrically linked to the shell.

Basis and assumptions

The pollution degree for industrial plants is normally "3". However, the calculation of the admissible operating voltage is based on the pollution degree "2", as the connectors are completely sealed and the contact parts are not subject to direct contamination or humidity.

Calculation basis for rated connector impulse voltage

Overvoltage category 700 V III

Material class 700 V II

STRAIGHT PLUG WITH PG GLAND ADAPTER PIN AND SOCKET CONTACTS*

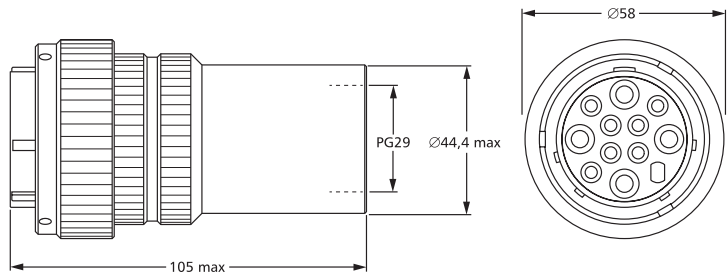

Pin contacts*		Socket contacts*	
Part number description CGL66PG28-11P-E1D-B-F0-SPL	Ordering designation CGL 120015-9	Part number description CGL66PG28-11S-E1D-B-F0-SPL	Ordering designation CGL120015-8

CABLE CONNECTING PLUG WITH PG GLAND ADAPTER PIN CONTACTS*

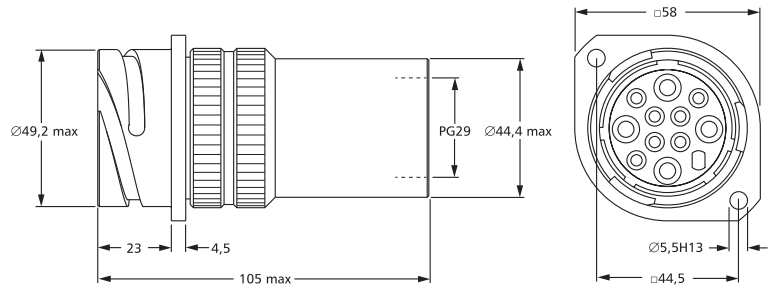

Pin contacts*		Socket contacts*	
Part number description CGL61PG28-11P-E1D-B-F0-SPL	Ordering designation CGL120015-10		

WALL MOUNTING RECEPTACLE PIN AND SOCKET CONTACTS*

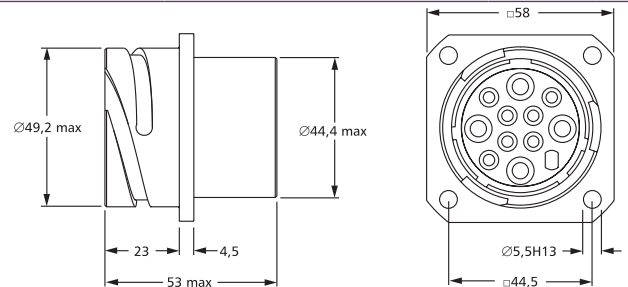

Pin contacts*		Socket contacts*	
Part number description CGL62A28-11P-E1D-B-F0-SPL	Ordering designation CGL120015-11	Part number description CGL62A28-11S-E1D-B-F0-SPL	Ordering designation CGL120015-12

***Ordering table for contacts (Contacts to be ordered separately)**

Number of contacts permitted	Contact size	Terminal size	Socket contact crimp	Pin contact crimp	Grounding screw
3	12	2,5 ²	031-8716-021	030-8719-049	-
3	12	4,0 ²	031-8716-022	030-8719-070	-
3	12	6,0 ²	031-8716-025	030-8719-071	-
1	12 Ground	2,5 ²	031-8716-031	030-8719-074	250-8501-023
1	12 Ground	4,0 ²	031-8716-032	030-8719-075	250-8501-023
1	12 Ground	6,0 ²	031-8716-033	030-8719-076	250-8501-023
7	16	1,5 ²	031-8716-019	030-8719-045	-

STRAIGHT PLUG WITH PG GLAND ADAPTER PIN AND SOCKET CONTACTS*

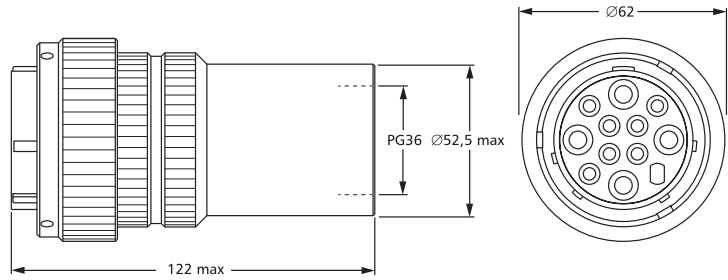

Pin contacts*		Socket contacts*	
Part number description CGL66PG36-11P-E1D-B-F0-SPL	Ordering designation CGL120015-2	Part number description CGL66PG36-11S-E1D-B-F0-SPL	Ordering designation CGL120015-1

CABLE CONNECTING PLUG WITH PG GLAND ADAPTER PIN CONTACTS*

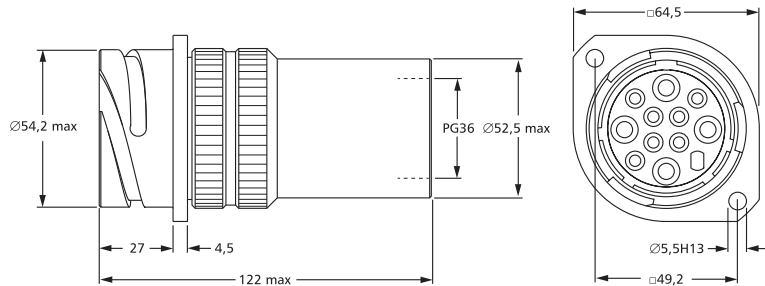

Pin contacts*		Socket contacts*	
Part number description CGL61PG36-11P-E1D-B-F0-SPL	Ordering designation CGL120015-3		

WALL MOUNTING RECEPTACLE PIN AND SOCKET CONTACTS*

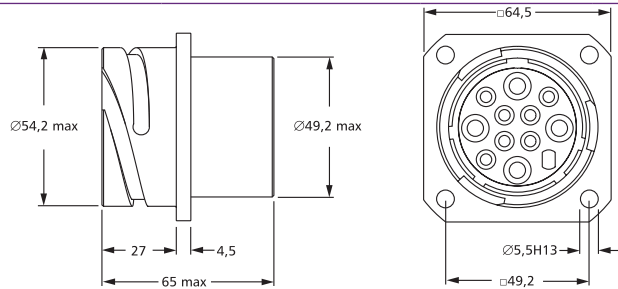

Pin contacts*		Socket contacts*	
Part number description CGL62A36-11P-E1D-B-F0-SPL	Ordering designation CGL120015-4	Part number description CGL62A36-11S-E1D-B-F0-SPL	Ordering designation CGL120015-5

***Ordering table for contacts (Contacts to be ordered separately)**

Number of contacts permitted	Contact size	Terminal size	Socket contact crimp	Pin contact crimp	Grounding screw
3	4	6 ²	031-8716-014	030-8719-057	
3	4	10 ²	031-8716-015	030-8719-058	
3	4	16 ²	031-8716-016	030-8719-059	
3	4	25 ²	031-8716-017	030-8719-043	
1	4 Ground	6 ²	031-8716-020	030-8719-060	250-8501-023
1	4 Ground	10 ²	031-8716-028	030-8719-061	250-8501-023
1	4 Ground	16 ²	031-8716-029	030-8719-062	250-8501-023
1	4 Ground	25 ²	031-8716-027	030-8719-044	250-8501-023
7	16	1,5 ²	031-8716-019	030-8719-045	

TOOLING

TOOLS FOR CGL #28



	Type	Contacts		Terminal size
		Pin	Socket	
Hand crimp tool (for #12 & #16 contacts as indicated) Crimp positioner	EUS101-2 CT120090-113	030-8719-049	031-8716-021	2,5 ²
Contact insertion tool, #12 contacts	CIT12	030-8719-070	031-8716-022	4,0 ²
Contact extraction tool, #12 contacts	CT121586-300	030-8719-071	031-8716-025	6,0 ²
Contact insertion tool, #16 contacts	CIT16	030-8719-045	031-8716-019	
Contact extraction tool, #16 contacts	CET-ATR-2160			



	Type	Contacts		Terminal size
		Pin	Socket	
Hand crimp tool for grounding contact, crimp positioner included in the tool above, no insertion or extraction tool needed	CCT-CGF-E	030-8719-074 030-8719-075 030-8719-076	031-8716-031 031-8716-032 031-8716-033	2,5 ² 4,0 ² 6,0 ²

TOOLS FOR CGL #36



	Type	Contacts		Terminal size
		Pin	Socket	
Hand crimp tool (for #16 contacts as indicated) Crimp positioner	EUS101-2 CT120090-113	030-8719-045	031-8716-019	1,5 ²
Contact insertion tool #16 contacts	CIT16			
Contact extraction tool #16 contacts	CET-ATR-2160			



	Type	Contacts		Terminal size
		Pin	Socket	
Hydraulic crimp tool for power and grounding contacts	HPW400U-ITT 121586-5257	030-8719-057 030-8719-058	031-8716-014 031-8716-015	6 ² 10 ²
Crimp die for hydraulic tool	121586-5230	030-8719-059	031-8716-016	16 ²
Contact insertion tool	CIT4	030-8719-043	031-8716-017	25 ²
Contact extraction tool #4 contacts	CT120090-56	030-8719-060 030-8719-061 030-8719-062 030-8719-044	031-8716-020 031-8716-028 031-8716-029 031-8716-027	6 ² 10 ² 16 ² 25 ²

PRODUCT SAFETY INFORMATION

1. MATERIAL CONTENT AND PHYSICAL FORM

Electrical connectors do not usually contain hazardous materials. They contain conducting and non-conducting materials and can be divided into two groups.

a) Printed circuit types and low cost audio types which employ all plastic insulators and casings.

b) Rugged, Fire Barrier and High Reliability types with metal casings and either natural rubber, synthetic rubber, plastic or glass insulating materials. Contact materials vary with type of connector and also application and are usually manufactured from either: Copper, copper alloys, nickel, alumel, chromel or steel. In special applications, other alloys may be specified.

CAUTION

2. FIRE CHARACTERISTICS AND ELECTRIC SHOCK HAZARD

There is no fire hazard when the connector is correctly wired and used within the specified parameters.

Incorrect wiring or assembly of the connector or careless use of metal tools or conductive fluids, or transit damage to any of the component parts may cause electric shock or burns. Live circuits must not be broken by separating mated connectors as this may cause arcing, ionization and burning. Heat dissipation is greater at maximum resistance in a circuit. Hot spots may occur when resistance is raised locally by damage, e.g. cracked or deformed contacts, broken strands of wire. Local overheating may also result from the use of the incorrect application tools or from poor quality soldering or slack screw terminals. Overheating may occur if the ratings in the product Data Sheet/Catalog are exceeded and can cause breakdown of insulation and hence electric shock. If heating is allowed to continue it intensifies by further increasing the local resistance through loss of temper of spring contacts, formation of oxide film on contacts and wires and leakage currents through carbonization of insulation and tracking paths. Fire can then result in the presence of combustible materials and this may release noxious fumes. Overheating may not be visually apparent. Burns may result from touching overheated components.

3. HANDLING

Care must be taken to avoid damage to any component parts of electrical connectors during installation and use. Although there are normally no sharp edges, care must be taken when handling certain components to avoid injury to fingers.

Electrical connectors may be damaged in transit to the customers, and damage may result in creation of hazards. Products should therefore be examined prior to installation/use and rejected if found to be damaged.

4. DISPOSAL

Incineration of certain materials may release noxious or even toxic fumes.

5. APPLICATION

Connectors with exposed contacts should not be selected for use on the current supply side of an electrical circuit, because an electric shock could result from touching exposed contacts on an unmated connector. Voltages in excess of 30V ac or 42.5V DC are potentially hazardous and care should be taken to ensure that such voltages cannot be transmitted in any way to exposed metal parts of the connector body. The connector and wiring should be checked, before making live, to have no damage to metal parts or insulators, no solder blobs, loose strands, conducting lubricants, swarf, or any other undesired conducting particles. Circuit resistance and continuity check should be made to make certain that there are no high resistance joints or spurious conducting paths. Always use the correct application tools as specified in the Data Sheet/Catalog. Do not permit untrained personnel to wire, assemble or tamper with connectors. For operation voltage please see appropriate national regulations.

IMPORTANT GENERAL INFORMATION

(i) **Air and creepage paths/Operating voltage.** The admissible operating voltages depend on the individual applications and the valid national and other applicable safety regulations. For this reason the air and creepage path data are only reference values. Observe reduction of air and creepage paths due to PC board and/or harnessing.

(ii) Temperature

All information given are temperature limits. The operation temperature depends on the individual application.

(iii) Other important information

Cannon continuously endeavors to improve their products. Therefore, Cannon products may deviate from the description, technical data and shape as shown in this catalog and data sheets.

ITT's Interconnect Solutions, is a division of ITT Corporation who manufactures the highest quality products available in the marketplace; however these products are

intended to be used in accordance with the specifications in this publication. Any use or application that deviates from the stated operating specifications is not recommended and may be unsafe. No information and data contained in this publication shall be construed to create any liability on the part of Cannon. Any new issue of this publication shall automatically invalidate and supersede any and all previous issues.

Product Warranty

A limited warranty applies to Cannon products. In general, except for obligations assumed by Cannon under this warranty, Cannon shall not be liable for any loss, damage, cost of repairs, incidental or consequential damages of any kind, whether or not based on express or implied warranty, contract, negligence or strict liability arising in connection with the design, manufacture, sale, use or repair of the products. Product availability, prices and delivery dates are exclusively subject to our respective order confirmation form; the same applies to orders based on development samples delivered. Please refer to www.ittcannon.com (General Terms of Sale) for the complete text of Cannon's applicable Terms and Conditions, including Warranty.

This publication is not to be construed as an offer. It is intended merely as an invitation to make an offer. By this publication, Cannon does not assume responsibility or any liability for any patent infringements or other rights of third parties which may result from its use.

Reprinting this publication is generally permitted, indicating the source. However, Cannon's prior consent must be obtained in all cases. "Engineered for life" is a registered trademark of ITT Corporation ©2015. All other trademarks or registered trademarks are property of their respective owners. All data subject to change without notice.

This document does not contain technical data whose export is restricted by the Arms Export Control Act (Title 22, U.S.C., App 2401 et. Seq.)



Connect with your ITT's representative today or visit us at www.ittcannon.com

Connect with the experts

ITT's Cannon brand is a world leader in the design and manufacture of highly engineered connector solutions for multiple end markets.



Why ITT

ITT is a focused multi-industrial company that designs and manufactures highly engineered critical components and customized technology solutions. ITT's Cannon brand is a leading global manufacturer of connector products serving international customers in aerospace, defense, medical, industrial and transportation end markets. ITT's Connector business, which also includes the Veam and BIW Connector Systems brand, manufactures and supplies a variety of connectors and interconnects that make it possible to transfer data, signal and power in an increasingly connected world.

Connect with your ITT Cannon representative today or visit us at www.ittcannon.com

Follow us 

CHINA - Shenzhen City
+86.755.2726.7888

GERMANY - Weinstadt
+49.7151.699.0

ITALY - Lainate
+39.02938721

KOREA
+82.2.702.7111

SHANGHAI
+ 86.21.2231.2222.2

UK - Basingstoke
+44.1256.347400

FRANCE
+33.1.60.04.93.93

HONG KONG
+852.2732.2720

JAPAN - Kanagawa
+81.462.57.2010

MEXICO - Nogales
+52.631.311005

SINGAPORE
+65 66974205

USA - Irvine, CA
+1.800.854.3028