

## Data sheet | Item number: 870-523/281-585

Component terminal block; double-deck; with varistor; for DIN-rail 35 x 15 and 35 x 7.5; 2.5 mm<sup>2</sup>; CAGE CLAMP®; 2,50 mm<sup>2</sup>; gray

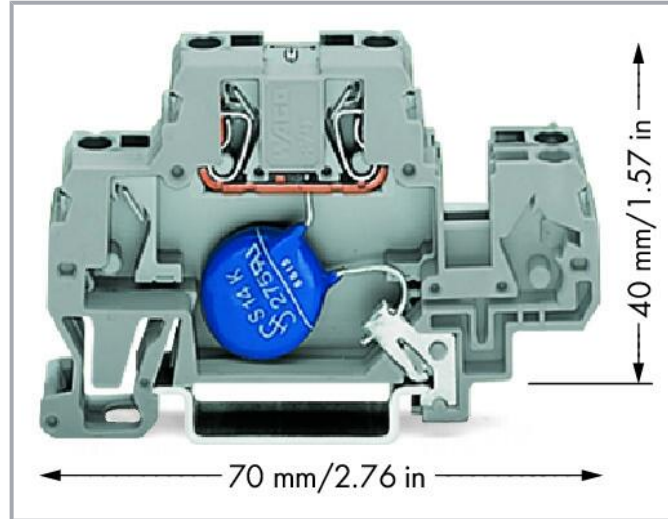

[www.wago.com/870-523/281-585](http://www.wago.com/870-523/281-585)



**i** Picture differs from the item.

Color: —

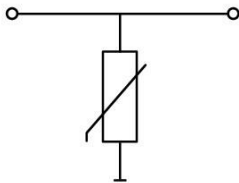

### Data

#### Electrical data

Nominal operating voltage	DC 110 V
Highest continuous voltage	DC 150 V
Rated continuous current	20 A
Nominal discharge current (8/20 µs) (line)	1 kA
Discharge current (max.)	4.5 kA
Protection level (8/20 µs)	≤ DC 300 V

Subject to changes. Please also observe the further product documentation!

WAGO GmbH & Co. KG  
Hansastr. 27  
32423 Minden  
Phone: +49571 887-0 | Fax: +49571 887-169  
Email: [info.de@wago.com](mailto:info.de@wago.com) | Web: [www.wago.com](http://www.wago.com)

Do you have any questions about our products?  
We are always happy to take your call at +49 (571) 887-44222.



Capacitance	≤ 800 pF
-------------	----------

**Connection data**

Connections (number)	2
Connection technology	CAGE CLAMP®
Solid conductor	0.08 ... 2.5 mm <sup>2</sup> / 28 ... 14 AWG
Fine-stranded conductor	0.08 ... 4 mm <sup>2</sup> / 28 ... 12 AWG
Fine-stranded conductor; with insulated ferrule	0.08 ... 1.5 mm <sup>2</sup> / 28 ... 14 AWG
Strip length	6 ... 7 mm / 0.24 ... 0.28 inches

**Physical data**

Width	10 mm / 0.394 inches
Height from upper-edge of DIN-rail	40 mm / 1.575 inches
Depth	70 mm / 2.756 inches

**Mechanical Data**

Mounting type	DIN-35 rail
---------------	-------------

**Material Data**

Color	gray
Insulation material	Polyamide (PA66)
Material group	I
Flammability class per UL94	V0
Fire load	0.259 MJ
Weight	10.4 g

**Environmental requirements**

Processing temperature	-35 ... +85 °C
------------------------	----------------

**Commercial data**

Product Group	16 (Rail Mounted Terminal Blocks with CCC)
eCl@ss 10.0	27-14-11-27
eCl@ss 9.0	27-14-11-27
ETIM 8.0	EC000903
ETIM 7.0	EC000903

Subject to changes. Please also observe the further product documentation!

WAGO GmbH & Co. KG  
Hansastr. 27  
32423 Minden  
Phone: +49571 887-0 | Fax: +49571 887-169  
Email: [info.de@wago.com](mailto:info.de@wago.com) | Web: [www.wago.com](http://www.wago.com)

Do you have any questions about our products?  
We are always happy to take your call at +49 (571) 887-44222.



PU (SPU)	25 pcs
Packaging type	box
Country of origin	DE
GTIN	4050821868361
Customs tariff number	85369010000

## Environmental Product Compliance

RoHS Compliance Status	Compliant, No Exemption
------------------------	-------------------------

## Optional accessories



### Insulation stop

Insulation stop		
	<b>Item no.: 280-472</b> Insulation stop; 0.75 - 1 mm <sup>2</sup> ; 5 pieces/strip; black	<a href="http://www.wago.com/280-472">www.wago.com/280-472</a>
	<b>Item no.: 280-470</b> Insulation stop; 0.08 - 0.2 mm <sup>2</sup> "s" (0.14 mm <sup>2</sup> "f-st"); 5 pieces/strip; white	<a href="http://www.wago.com/280-470">www.wago.com/280-470</a>
	<b>Item no.: 280-471</b> Insulation stop; 0.25 - 0.5 mm <sup>2</sup> ; 5 pieces/strip; light gray	<a href="http://www.wago.com/280-471">www.wago.com/280-471</a>



### Jumpers

Jumper		
	<b>Item no.: 280-492</b> Jumper; 2-way; insulated; gray	<a href="http://www.wago.com/280-492">www.wago.com/280-492</a>

### Marking accessories

Marker		
	<b>Item no.: 2009-145</b> Mini-WSB Inline; for Smart Printer; 1700 pieces on roll; stretchable 5 - 5.2 mm; plain; snap-on type; white	<a href="http://www.wago.com/2009-145">www.wago.com/2009-145</a>
	<b>Item no.: 248-501</b> Mini-WSB marking card; as card; not stretchable; plain; snap-on type; white	<a href="http://www.wago.com/248-501">www.wago.com/248-501</a>

### End plate

End plate		
	<b>Item no.: 870-518</b> End and intermediate plate; 2 mm thick; gray	<a href="http://www.wago.com/870-518">www.wago.com/870-518</a>
	<b>Item no.: 870-519</b> End and intermediate plate; 2 mm thick; orange	<a href="http://www.wago.com/870-519">www.wago.com/870-519</a>

### Tool

Subject to changes. Please also observe the further product documentation!

Operating tool



Item no.: 210-720

Operating tool; Blade: 3.5 x 0.5 mm; with a partially insulated shaft; multicoloured

[www.wago.com/210-720](http://www.wago.com/210-720)

**Downloads**

**Documentation**

**Bid Text**

870-523/281-585 X81 - Datei	2019 Feb 19	xml 3.5 kB	Download
--------------------------------	-------------	---------------	----------

870-523/281-585 doc - Datei	2015 Feb 11	doc 27.1 kB	Download
--------------------------------	-------------	----------------	----------

**Additional Information**

Disposal and Recycling Electrical and electronic equipment, Batteries, Packaging	V 1.1.0 2022 Aug 18	pdf 2.2 MB	Download
---	------------------------	---------------	----------

**CAD/CAE-Data**

**CAD data**

2D/3D Models 870-523/281-585	URL	Download
------------------------------	-----	----------

**CAE data**

EPLAN Data Portal 870-523/281-585	URL	Download
-----------------------------------	-----	----------

WSCAD Universe 870-523/281-585	URL	Download
--------------------------------	-----	----------

WSCAD Universe 870-523/281-585	URL	Download
--------------------------------	-----	----------

EPLAN Data Portal 870-523/281-585	URL	Download
-----------------------------------	-----	----------

ZUKEN Portal 870-523/281-585	URL	Download
------------------------------	-----	----------

**Environmental Product Compliance**

**Compliance Search**

Subject to changes. Please also observe the further product documentation!

WAGO GmbH & Co. KG  
Hansastr. 27  
32423 Minden  
Phone: +49571 887-0 | Fax: +49571 887-169  
Email: [info.de@wago.com](mailto:info.de@wago.com) | Web: [www.wago.com](http://www.wago.com)

Do you have any questions about our products?  
We are always happy to take your call at +49 (571) 887-44222.

Data sheet | Item number: 870-523/281-585

[www.wago.com/870-523/281-585](http://www.wago.com/870-523/281-585)



Environmental Product Compliance 870-523/281-585

URL

Download

Component terminal block; double-deck; with varistor; for DIN-rail 35 x 15 and 35 x 7.5; 2.5 mm<sup>2</sup>; CAGE CLAMP®; 2,50 mm<sup>2</sup>; gray

---

## Installation Notes

Subject to changes. Please also observe the further product documentation!

---

WAGO GmbH & Co. KG

Hansastr. 27

32423 Minden

Phone: +49571 887-0 | Fax: +49571 887-169

Email: [info.de@wago.com](mailto:info.de@wago.com) | Web: [www.wago.com](http://www.wago.com)

Do you have any questions about our products?

We are always happy to take your call at +49 (571) 887-44222.