

CG2H40025

25 W, 28 V RF Power GaN HEMT

Description

WolfSpeed's CG2H40025 is an unmatched, gallium nitride (GaN) high electron mobility transistor (HEMT). The CG2H40025, operating from a 28 volt rail, offers a general purpose, broadband solution to a variety of RF and microwave applications. GaN HEMTs offer high efficiency, high gain and wide bandwidth capabilities making the CG2H40025 ideal for linear and compressed amplifier circuits. The transistor is available in a screw-down, flange package and solder-down, pill package.

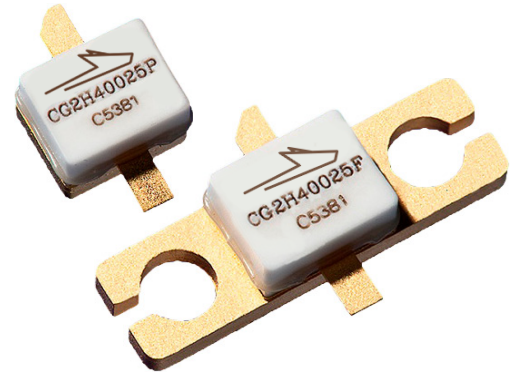

PNs: CG2H40025P and CG2H40025F
Package Types: 440196 and 440166

Features

- Up to 6 GHz Operation
- 17 dB Small Signal Gain at 2.0 GHz
- 15 dB Small Signal Gain at 4.0 GHz
- 30 W typical P_{SAT}
- 70% Efficiency at P_{SAT}
- 28 V Operation

Applications

- 2-Way Private Radio
- Broadband Amplifiers
- Cellular Infrastructure
- Test Instrumentation
- Class A, AB, Linear amplifiers suitable for OFDM, W-CDMA, EDGE, CDMA waveforms

 Large Signal Models Available for ADS and MWO





Absolute Maximum Ratings (not simultaneous) at 25°C Case Temperature

Parameter	Symbol	Rating	Units	Conditions
Drain-Source Voltage	V_{DSS}	120	V	25°C
Gate-to-Source Voltage	V_{GS}	-10, +2		
Storage Temperature	T_{STG}	-65, +150	°C	
Operating Junction Temperature	T_J	225		
Maximum Forward Gate Current	I_{GMAX}	7.0	mA	25°C
Maximum Drain Current ¹	I_{DMAX}	3	A	
Soldering Temperature ²	T_S	245	°C	
Screw Torque	τ	40	in-oz	
Thermal Resistance, Junction to Case ³	$R_{\theta JC}$	3.8	°C/W	85°C
Case Operating Temperature ^{3,4}	T_C	-40, +150	°C	

Notes:

¹ Current limit for long term, reliable operation

² Refer to the Application Note on soldering at wolfspeed.com/rf/document-library

³ Measured for the CG2H40025F at $P_{DISS} = 28.8$ W

⁴ See also, the Power Dissipation De-rating Curve on page 6

Electrical Characteristics ($T_C = 25^\circ\text{C}$)

Characteristics	Symbol	Min.	Typ.	Max.	Units	Conditions
DC Characteristics¹						
Gate Threshold Voltage	$V_{GS(th)}$	-3.8	-3.0	-2.3	V_{DC}	$V_{DS} = 10$ V, $I_D = 7.2$ mA
Gate Quiescent Voltage	$V_{GS(Q)}$	—	-2.7	—		$V_{DS} = 28$ V, $I_D = 250$ mA
Saturated Drain Current	I_{DS}	5.2	7.2	—	A	$V_{DS} = 6.0$ V, $V_{GS} = 2.0$ V
Drain-Source Breakdown Voltage	V_{BR}	84	—	—	V_{DC}	$V_{GS} = -8$ V, $I_D = 7.2$ mA
RF Characteristics² ($T_C = 25^\circ\text{C}$, $F_0 = 3.7$ GHz unless otherwise noted)						
Small Signal Gain	G_{SS}	13.0	14.8	—	dB	$V_{DD} = 28$ V, $I_{DQ} = 250$ mA
Output Power ³	P_{SAT}	25	34	—	—	
Drain Efficiency ⁴	η	57	71	—	%	$V_{DD} = 28$ V, $I_{DQ} = 250$ mA, P_{SAT}
Output Mismatch Stress	VSWR	—	—	10 : 1	Y	No damage at all phase angles, $V_{DD} = 28$ V, $I_{DQ} = 250$ mA, $P_{OUT} = 25$ W CW
Dynamic Characteristics						
Input Capacitance	C_{GS}	—	7.5	—	pF	$V_{DS} = 28$ V, $V_{GS} = -8$ V, $f = 1$ MHz
Output Capacitance	C_{DS}	—	2.4	—		
Feedback Capacitance	C_{GD}	—	0.4	—		

Notes:

¹ Measured on wafer prior to packaging

² Measured in CG2H40025-AMP

³ P_{SAT} is defined as $I_G = 0.72$ mA

⁴ Drain Efficiency = P_{OUT} / P_{DC}

Typical Performance

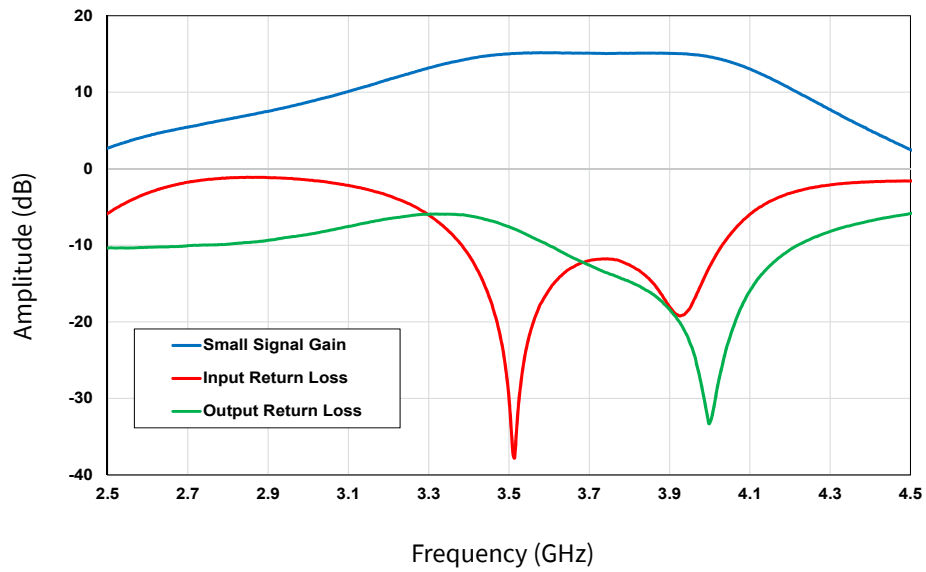

Figure 1. Small Signal Gain and Return Loss vs Frequency of the CG2H40025F in the CG2H40025-AMP

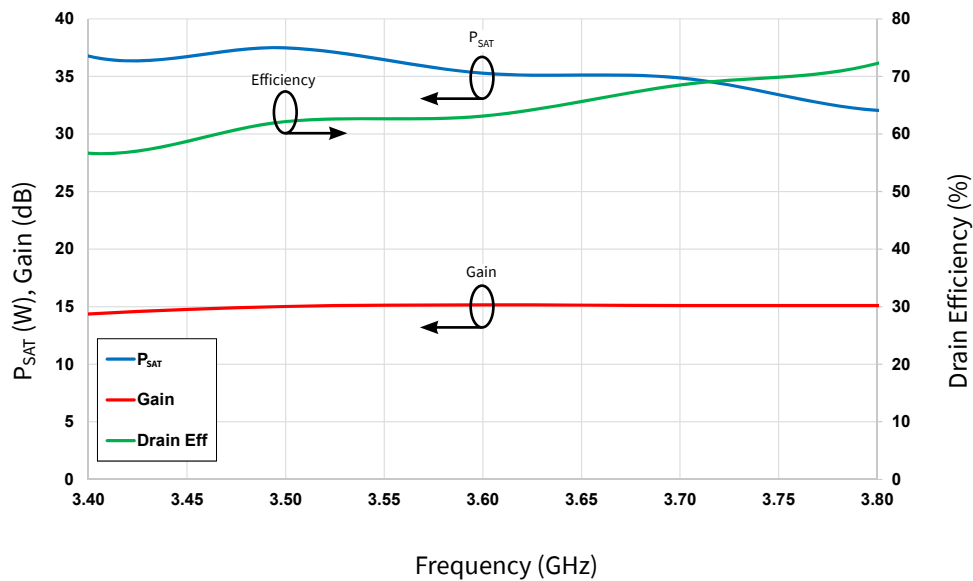

Figure 2. P_{SAT} , Gain, and Drain Efficiency vs Frequency of the CG2H40025F in the CG2H40025-AMP
 $V_{DD} = 28\text{ V}$, $I_{DQ} = 250\text{ mA}$



CG2H40025F Typical Performance

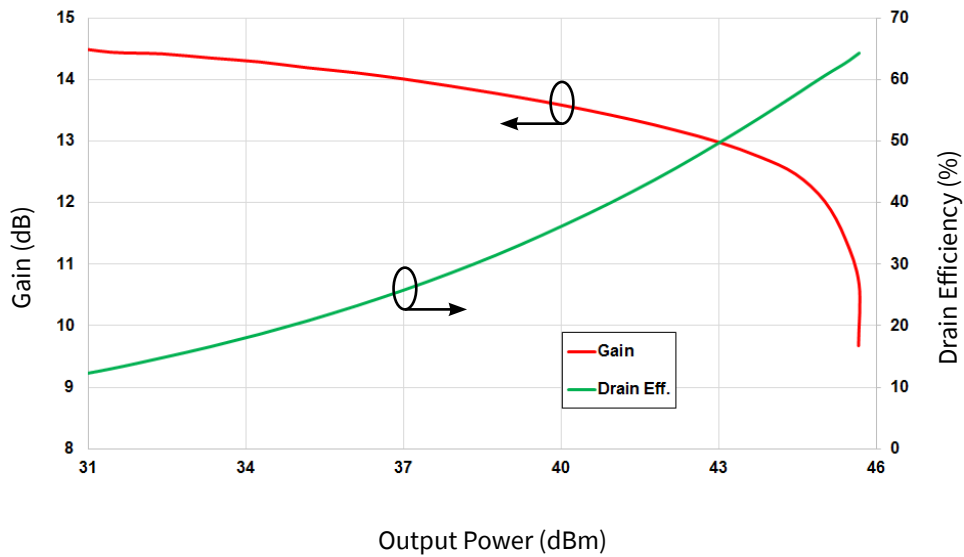

Figure 3. Swept CW Data of CG2H40025 vs. Output Power in CG2H40025-AMP
 $V_{DD} = 28\text{ V}$, $I_{DQ} = 250\text{ mA}$, Freq = 3.6 GHz

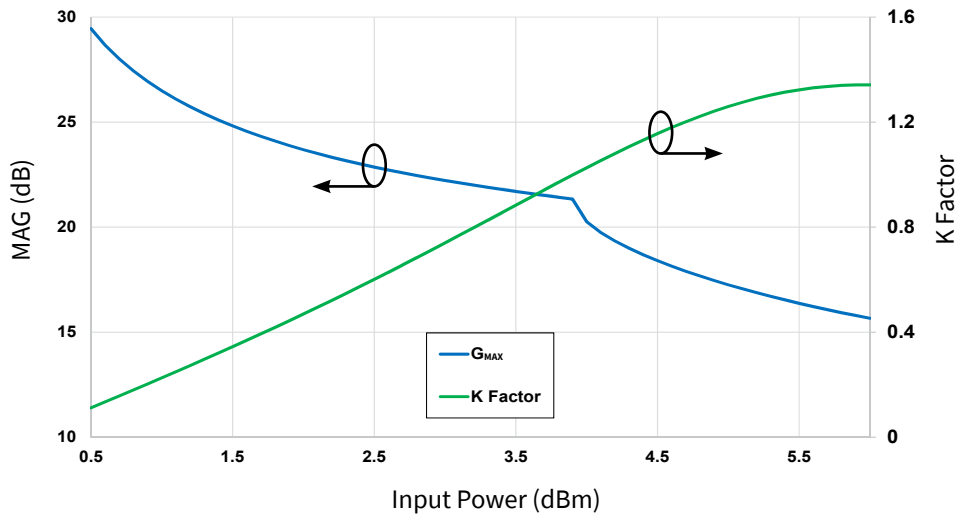

Figure 4. Maximum Available Gain and K Factor of the CG2H40025
 $V_{DD} = 28\text{ V}$, $I_{DQ} = 250\text{ mA}$

Typical Noise Performance

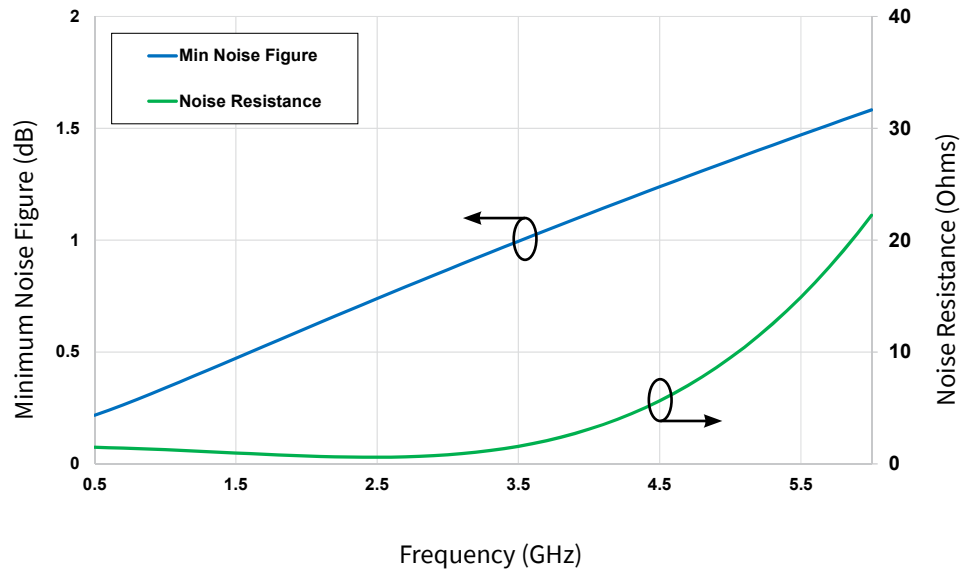

Figure 5. Simulated Minimum Noise Figure and Noise Resistance vs Frequency of the CG2H40025F
 $V_{DD} = 28\text{ V}$, $I_{DQ} = 250\text{ mA}$

Electrostatic Discharge (ESD) Classifications

Parameter	Symbol	Class	Classification Level	Test Methodology
Human Body Model	HBM	1A	ANSI/ESDA/JEDEC JS-001 Table 3	JEDEC JESD22 A114-D
Charge Device Model	CDM	C2B	ANSI/ESDA/JEDEC JS-002 Table 3	JEDEC JESD22 C101-C



Source and Load Impedances

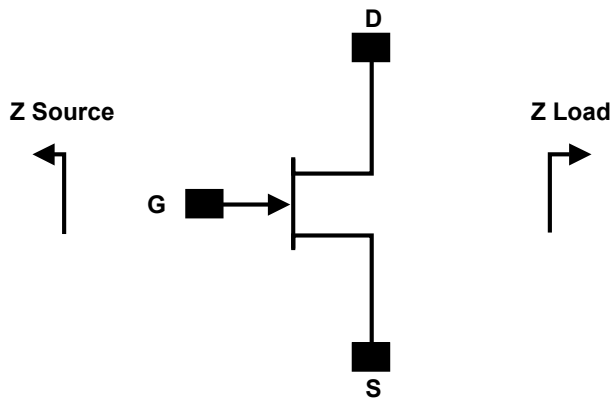

Frequency (MHz)	Z Source	Z Load
500	7.75 + j15.5	20 + j5.2
1000	3.11 + j5.72	17 + j6.66
1500	2.86 + j1.63	16.8 + j3.2
2500	2.4 - j3.52	8.02 + j4.32
3500	1.31 - j7.3	5.85 - j0.51

Notes:

¹ $V_{DD} = 28\text{ V}$, $I_{DQ} = 250\text{ mA}$ in the 440166 package

² Optimized for P_{SAT} and PAE

³ When using this device at low frequency, series resistors should be used to maintain amplifier stability

CG2H40025 Power Dissipation De-rating Curve

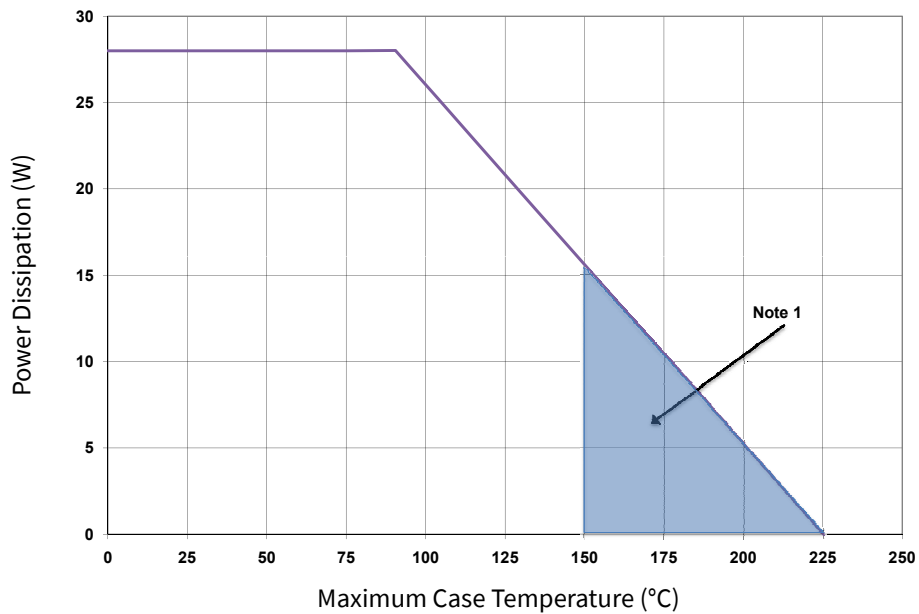

Note:

¹ Area exceeds Maximum Case Operating Temperature (See Page 2)



CG2H40025-AMP Demonstration Amplifier Circuit Schematic

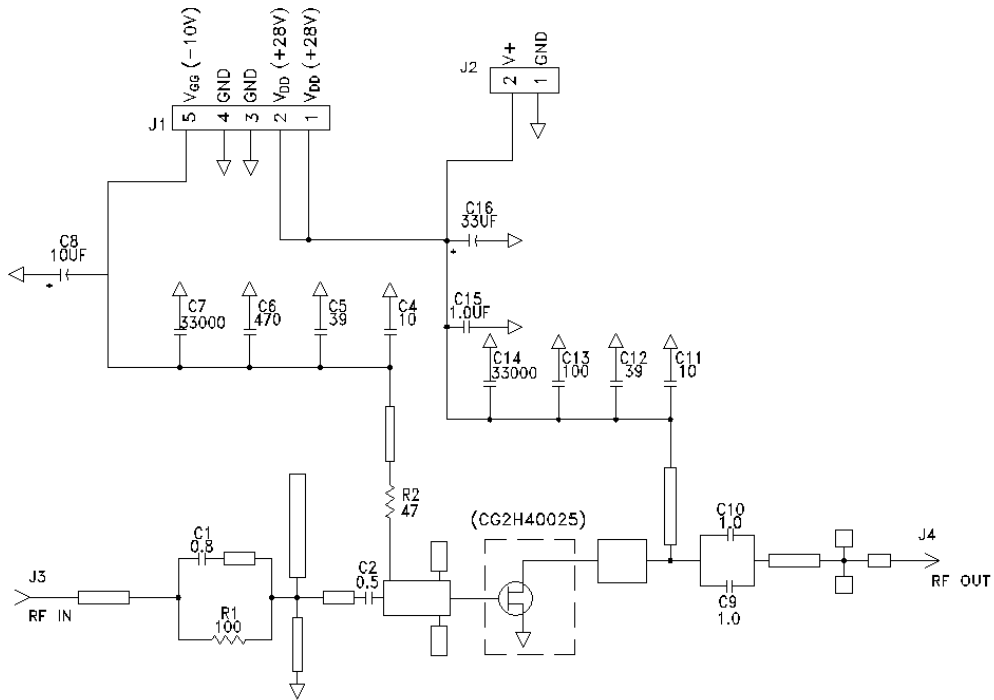

CG2H40025-AMP Demonstration Amplifier Circuit Outline

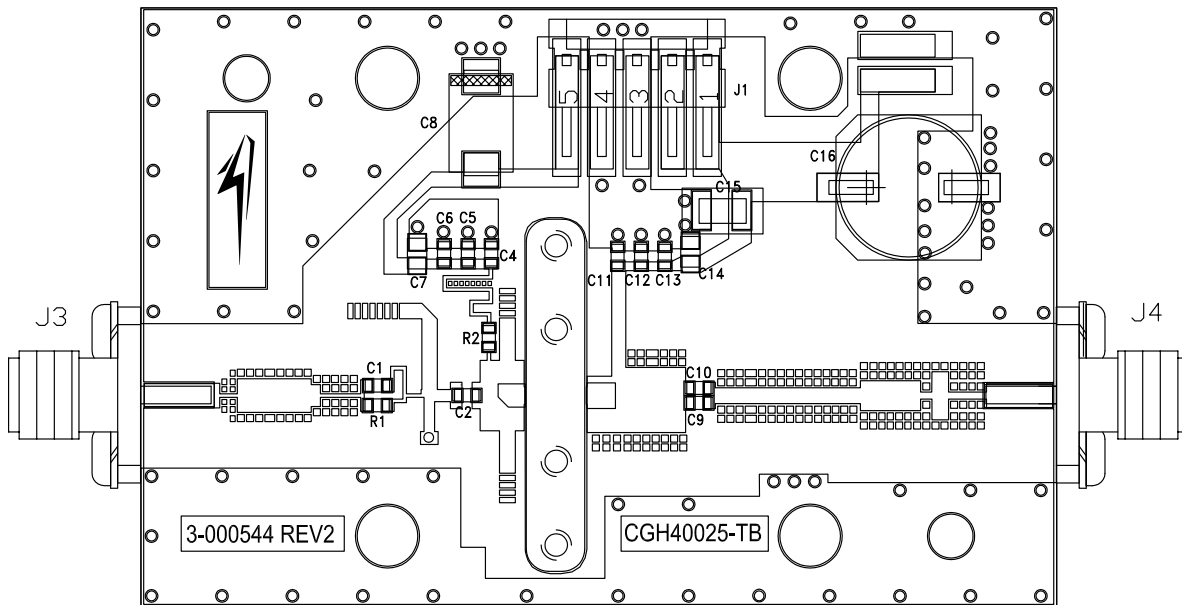



CG2H40025-AMP Demonstration Amplifier Circuit Bill of Materials

Designator	Description	Qty
R2	RES, 1/16W, 0603, 1%, 47 OHMS	1
R1	RES, 1/16W, 0603, 1%, 100 OHMS	1
C6	CAP, 470pF, 5%, 100V, 0603	1
C16	CAP, 33μF, 20%, G CASE	1
C15	CAP, 1.0μF, 100V, 10%, X7R, 1210	1
C8	CAP 10μF 16V TANTALUM	1
C13	CAP, 100.0pF, +/-5%, 0603	1
C1	CAP, 0.8pF, +/-0.1pF, 0603	1
C2	CAP, 0.5pF, +/-0.05pF, 0603	1
C9, C10	CAP, 1.0pF, +/-0.1pF, 0603	2
C4, C11	CAP, 10.0pF, +/-5%, 0603	2
C5, C12	CAP, 39pF, +/-5%, 0603	2
C7, C14	CAP, 33000pF, 0805, 100V, X7R	2
J3, J4	CONN SMA STR PANEL JACK RECP	2
J1	HEADER RT>PLZ .1CEN LK 5POS	1
—	PCB, RO4350B, Er = 3.48, h = 20 mil	1
—	CG2H40025F or CG2H40025P	1

CG2H40025F-AMP Demonstration Amplifier Circuit

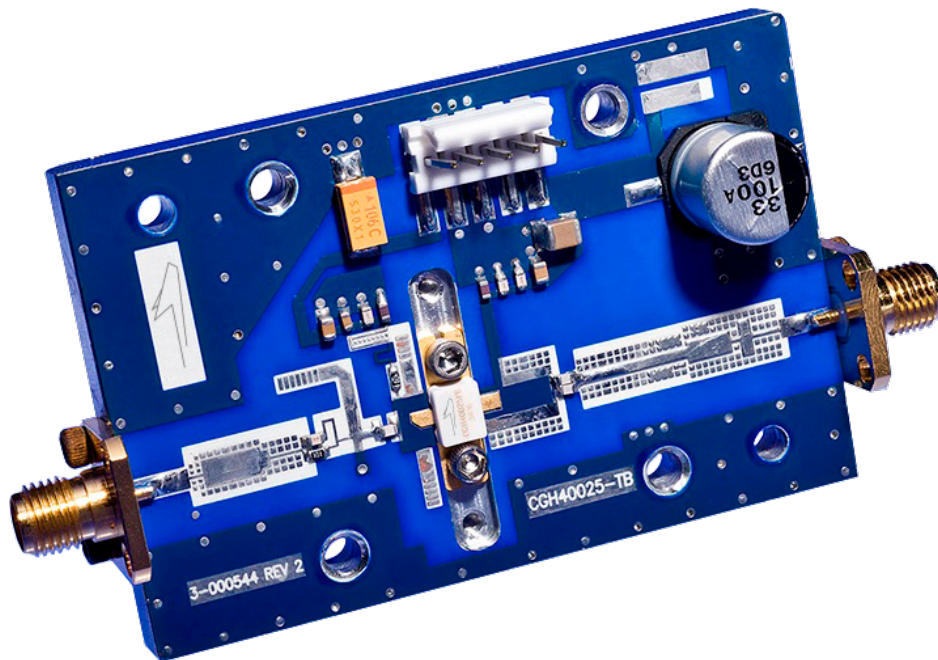



Typical Package S-Parameters for CG2H40025
 (Small Signal, $V_{DS} = 28\text{ V}$, $I_{DQ} = 100\text{ mA}$, angle in degrees)

Frequency	Mag S11	Ang S11	Mag S21	Ang S21	Mag S12	Ang S12	Mag S22	Ang S22
0.5	0.869	-144.08	16.82	95.26	0.024	10.68	0.425	-137.01
0.6	0.864	-151.15	14.18	89.71	0.024	6.25	0.431	-142.15
0.7	0.861	-156.57	12.22	84.97	0.024	2.64	0.438	-145.82
0.8	0.859	-160.90	10.70	80.75	0.025	-0.43	0.446	-148.58
0.9	0.858	-164.50	9.49	76.90	0.025	-3.10	0.454	-150.76
1	0.857	-167.56	8.51	73.32	0.025	-5.46	0.463	-152.56
1.1	0.856	-170.23	7.70	69.96	0.025	-7.59	0.472	-154.11
1.2	0.856	-172.60	7.02	66.75	0.025	-9.52	0.482	-155.49
1.3	0.855	-174.74	6.43	63.69	0.025	-11.28	0.492	-156.77
1.4	0.855	-176.71	5.93	60.74	0.025	-12.87	0.502	-157.98
1.5	0.854	-178.52	5.49	57.88	0.025	-14.32	0.513	-159.15
1.6	0.854	179.77	5.10	55.12	0.025	-15.64	0.523	-160.30
1.7	0.854	178.17	4.76	52.43	0.025	-16.82	0.533	-161.43
1.8	0.854	176.64	4.45	49.81	0.025	-17.86	0.543	-162.56
1.9	0.853	175.18	4.18	47.25	0.025	-18.78	0.553	-163.69
2	0.853	173.78	3.93	44.76	0.025	-19.56	0.562	-164.83
2.1	0.853	172.43	3.70	42.32	0.025	-20.21	0.572	-165.97
2.2	0.853	171.11	3.50	39.93	0.025	-20.73	0.581	-167.12
2.3	0.852	169.83	3.31	37.59	0.025	-21.10	0.590	-168.28
2.4	0.852	168.58	3.14	35.30	0.025	-21.33	0.599	-169.44
2.5	0.852	167.35	2.98	33.06	0.025	-21.41	0.607	-170.61
2.6	0.851	166.15	2.84	30.85	0.025	-21.34	0.615	-171.78
2.7	0.851	164.96	2.70	28.69	0.025	-21.12	0.623	-172.96
2.8	0.851	163.79	2.58	26.56	0.025	-20.73	0.630	-174.14
2.9	0.850	162.64	2.47	24.48	0.025	-20.18	0.637	-175.32
3	0.850	161.49	2.36	22.42	0.025	-19.47	0.644	-176.51
3.2	0.849	159.23	2.17	18.42	0.025	-17.56	0.657	-178.89
3.4	0.848	157.00	2.00	14.55	0.026	-15.02	0.669	178.72
3.6	0.847	154.78	1.85	10.79	0.027	-11.92	0.679	176.34
3.8	0.845	152.58	1.73	7.14	0.028	-8.41	0.689	173.95
4	0.844	150.37	1.61	3.60	0.029	-4.65	0.697	171.56
4.2	0.843	148.16	1.51	0.16	0.031	-0.86	0.705	169.18
4.4	0.841	145.94	1.42	-3.19	0.034	2.77	0.712	166.79
4.6	0.839	143.71	1.34	-6.44	0.037	6.05	0.718	164.40
4.8	0.837	141.46	1.27	-9.61	0.041	8.89	0.723	162.00
5	0.835	139.18	1.21	-12.69	0.046	11.21	0.728	159.60
5.2	0.833	136.87	1.15	-15.69	0.051	13.00	0.732	157.18
5.4	0.830	134.54	1.10	-18.61	0.057	14.29	0.735	154.75
5.6	0.828	132.16	1.05	-21.45	0.064	15.09	0.738	152.31
5.8	0.825	129.75	1.01	-24.21	0.072	15.47	0.740	149.84
6	0.822	127.30	0.97	-26.89	0.080	15.46	0.742	147.35

To download the s-parameters in s2p format, go to the [CG2H40025 Product page](#) and click on the documentation tab.



Typical Package S-Parameters for CG2H40025
 (Small Signal, $V_{DS} = 28\text{ V}$, $I_{DQ} = 250\text{ mA}$, angle in degrees)

Frequency	Mag S11	Ang S11	Mag S21	Ang S21	Mag S12	Ang S12	Mag S22	Ang S22
0.5	0.881	-151.40	18.76	93.94	0.017	12.31	0.488	-157.38
0.6	0.878	-157.62	15.77	89.14	0.018	9.22	0.495	-160.94
0.7	0.876	-162.40	13.57	85.03	0.018	6.84	0.501	-163.55
0.8	0.874	-166.25	11.89	81.37	0.018	4.92	0.505	-165.55
0.9	0.872	-169.47	10.56	78.02	0.018	3.33	0.510	-167.15
1	0.871	-172.24	9.49	74.89	0.018	1.99	0.515	-168.49
1.1	0.870	-174.67	8.60	71.93	0.019	0.84	0.519	-169.64
1.2	0.869	-176.86	7.86	69.10	0.019	-0.14	0.524	-170.66
1.3	0.867	-178.85	7.22	66.37	0.019	-0.99	0.529	-171.60
1.4	0.866	179.31	6.68	63.73	0.019	-1.72	0.534	-172.47
1.5	0.865	177.59	6.20	61.17	0.020	-2.33	0.539	-173.30
1.6	0.863	175.98	5.78	58.67	0.020	-2.84	0.544	-174.11
1.7	0.862	174.44	5.41	56.22	0.020	-3.26	0.549	-174.89
1.8	0.861	172.98	5.08	53.83	0.020	-3.58	0.554	-175.67
1.9	0.859	171.57	4.78	51.48	0.021	-3.81	0.559	-176.45
2	0.858	170.22	4.51	49.18	0.021	-3.95	0.564	-177.23
2.1	0.856	168.91	4.27	46.91	0.021	-4.00	0.569	-178.01
2.2	0.855	167.63	4.05	44.68	0.022	-3.97	0.574	-178.80
2.3	0.854	166.38	3.85	42.48	0.022	-3.86	0.579	-179.60
2.4	0.852	165.17	3.66	40.32	0.023	-3.67	0.584	179.58
2.5	0.850	163.97	3.49	38.19	0.023	-3.40	0.589	178.76
2.6	0.849	162.80	3.33	36.08	0.024	-3.06	0.593	177.93
2.7	0.847	161.64	3.19	34.01	0.024	-2.65	0.598	177.09
2.8	0.846	160.50	3.05	31.96	0.025	-2.18	0.602	176.23
2.9	0.844	159.38	2.93	29.94	0.025	-1.64	0.607	175.36
3	0.842	158.26	2.81	27.95	0.026	-1.05	0.611	174.48
3.2	0.839	156.06	2.60	24.03	0.027	0.26	0.619	172.70
3.4	0.836	153.89	2.41	20.21	0.029	1.71	0.627	170.87
3.6	0.832	151.74	2.25	16.47	0.031	3.23	0.634	169.01
3.8	0.829	149.60	2.10	12.82	0.033	4.77	0.640	167.11
4	0.825	147.46	1.97	9.25	0.036	6.24	0.646	165.18
4.2	0.821	145.33	1.86	5.75	0.039	7.61	0.651	163.22
4.4	0.817	143.19	1.76	2.33	0.043	8.82	0.656	161.23
4.6	0.814	141.03	1.66	-1.02	0.047	9.85	0.660	159.21
4.8	0.810	138.86	1.58	-4.31	0.051	10.66	0.664	157.17
5	0.806	136.67	1.51	-7.52	0.057	11.24	0.667	155.10
5.2	0.801	134.46	1.44	-10.68	0.062	11.59	0.669	153.00
5.4	0.797	132.22	1.38	-13.77	0.069	11.71	0.671	150.87
5.6	0.793	129.95	1.32	-16.80	0.076	11.60	0.673	148.72
5.8	0.788	127.64	1.27	-19.78	0.083	11.28	0.674	146.53
6	0.783	125.29	1.23	-22.69	0.092	10.74	0.675	144.31

To download the s-parameters in s2p format, go to the [CG2H40025 Product page](#) and click on the documentation tab.



Typical Package S-Parameters for CG2H40025
 (Small Signal, $V_{DS} = 28\text{ V}$, $I_{DQ} = 400\text{ mA}$, angle in degrees)

Frequency	Mag S11	Ang S11	Mag S21	Ang S21	Mag S12	Ang S12	Mag S22	Ang S22
0.5	0.891	-154.59	18.81	93.00	0.015	13.05	0.509	-162.83
0.6	0.888	-160.39	15.79	88.47	0.015	10.57	0.515	-165.80
0.7	0.886	-164.86	13.57	84.59	0.015	8.73	0.519	-168.00
0.8	0.885	-168.47	11.89	81.12	0.016	7.31	0.524	-169.72
0.9	0.883	-171.51	10.56	77.93	0.016	6.19	0.527	-171.12
1	0.882	-174.13	9.49	74.94	0.016	5.28	0.531	-172.30
1.1	0.881	-176.46	8.61	72.11	0.016	4.55	0.535	-173.34
1.2	0.879	-178.55	7.87	69.39	0.017	3.95	0.538	-174.27
1.3	0.878	179.53	7.23	66.77	0.017	3.47	0.542	-175.12
1.4	0.876	177.75	6.69	64.23	0.017	3.08	0.546	-175.93
1.5	0.875	176.09	6.22	61.76	0.017	2.79	0.550	-176.70
1.6	0.873	174.52	5.80	59.34	0.018	2.57	0.554	-177.44
1.7	0.872	173.02	5.43	56.97	0.018	2.43	0.558	-178.17
1.8	0.870	171.58	5.11	54.65	0.019	2.36	0.562	-178.90
1.9	0.869	170.20	4.81	52.36	0.019	2.35	0.566	-179.62
2	0.867	168.87	4.55	50.12	0.019	2.41	0.570	179.65
2.1	0.865	167.57	4.30	47.91	0.020	2.52	0.574	178.93
2.2	0.864	166.31	4.08	45.73	0.020	2.69	0.578	178.19
2.3	0.862	165.08	3.88	43.58	0.021	2.91	0.582	177.45
2.4	0.860	163.87	3.70	41.46	0.021	3.18	0.586	176.69
2.5	0.858	162.68	3.53	39.36	0.022	3.50	0.590	175.93
2.6	0.856	161.52	3.37	37.30	0.023	3.86	0.594	175.15
2.7	0.854	160.37	3.23	35.26	0.023	4.25	0.597	174.37
2.8	0.852	159.23	3.09	33.24	0.024	4.68	0.601	173.57
2.9	0.850	158.11	2.97	31.25	0.025	5.14	0.605	172.76
3	0.848	157.00	2.85	29.28	0.026	5.62	0.608	171.94
3.2	0.844	154.81	2.64	25.40	0.028	6.63	0.615	170.27
3.4	0.840	152.64	2.46	21.61	0.030	7.66	0.621	168.56
3.6	0.836	150.50	2.29	17.90	0.032	8.69	0.627	166.80
3.8	0.832	148.36	2.15	14.26	0.035	9.67	0.632	165.01
4	0.828	146.23	2.02	10.70	0.038	10.55	0.637	163.18
4.2	0.823	144.10	1.91	7.20	0.041	11.32	0.641	161.32
4.4	0.819	141.97	1.80	3.78	0.045	11.94	0.645	159.43
4.6	0.814	139.82	1.71	0.41	0.050	12.40	0.649	157.50
4.8	0.810	137.66	1.63	-2.89	0.055	12.68	0.652	155.54
5	0.805	135.48	1.55	-6.13	0.060	12.79	0.654	153.56
5.2	0.800	133.27	1.48	-9.30	0.066	12.71	0.656	151.54
5.4	0.795	131.04	1.42	-12.43	0.073	12.45	0.658	149.49
5.6	0.790	128.78	1.37	-15.49	0.080	12.01	0.659	147.40
5.8	0.785	126.49	1.32	-18.50	0.088	11.40	0.660	145.28
6	0.779	124.15	1.27	-21.45	0.096	10.62	0.660	143.13

To download the s-parameters in s2p format, go to the [CG2H40025](#) Product page and click on the documentation tab.



Product Dimensions CG2H40025F (Package Type — 440166)

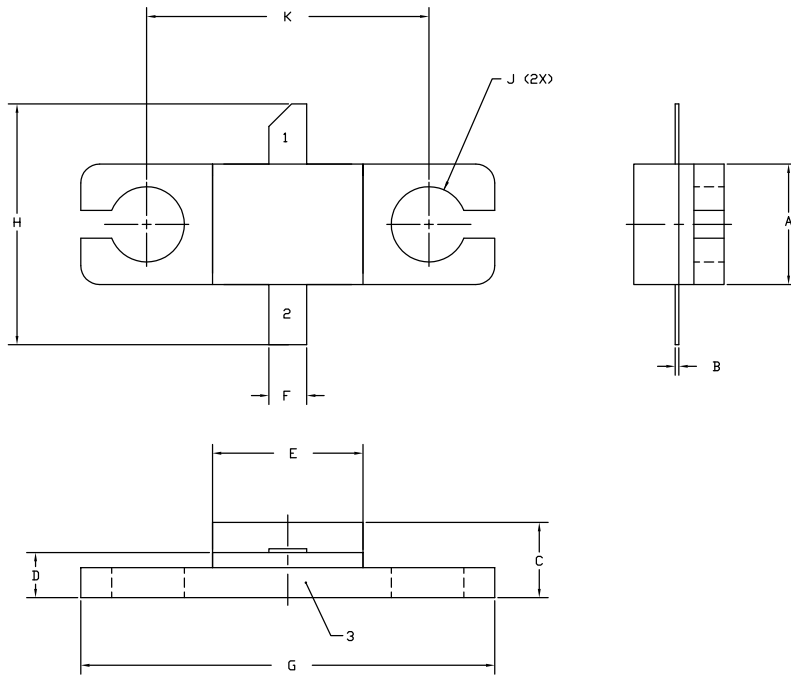

- NOTES:
1. DIMENSIONING AND TOLERANCING PER ANSI Y14.5M, 1982.
 2. CONTROLLING DIMENSION: INCH.
 3. ADHESIVE FROM LID MAY EXTEND A MAXIMUM OF 0.020" BEYOND EDGE OF LID.
 4. LID MAY BE MISALIGNED TO THE BODY OF THE PACKAGE BY A MAXIMUM OF 0.008" IN ANY DIRECTION.
 5. ALL PLATED SURFACES ARE NI/AU

DIM	INCHES		MILLIMETERS	
	MIN	MAX	MIN	MAX
A	0.155	0.165	3.94	4.19
B	0.004	0.006	0.10	0.15
C	0.115	0.135	2.92	3.43
D	0.057	0.067	1.45	1.70
E	0.195	0.205	4.95	5.21
F	0.045	0.055	1.14	1.40
G	0.545	0.555	13.84	14.09
H	0.280	0.360	7.11	9.14
J	Ø .100		2.54	
K	0.375		9.53	

- PIN 1. GATE
 PIN 2. DRAIN
 PIN 3. SOURCE

Product Dimensions CG2H40025P (Package Type — 440196)

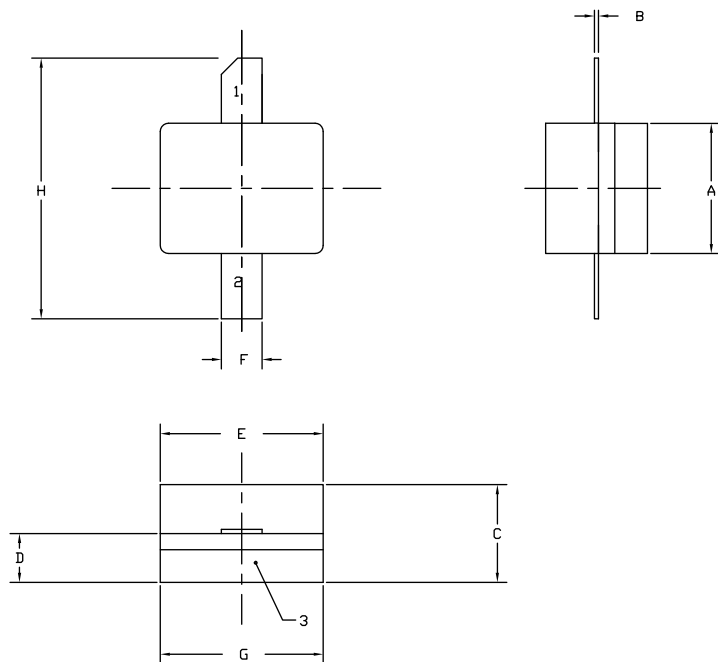



- NOTES:
1. DIMENSIONING AND TOLERANCING PER ANSI Y14.5M, 1982.
 2. CONTROLLING DIMENSION: INCH.
 3. ADHESIVE FROM LID MAY EXTEND A MAXIMUM OF 0.020" BEYOND EDGE OF LID.
 4. LID MAY BE MISALIGNED TO THE BODY OF THE PACKAGE BY A MAXIMUM OF 0.008" IN ANY DIRECTION.
 5. ALL PLATED SURFACES ARE NI/AU

DIM	INCHES		MILLIMETERS	
	MIN	MAX	MIN	MAX
A	0.155	0.165	3.94	4.19
B	0.003	0.006	0.10	0.15
C	0.115	0.135	2.92	3.17
D	0.057	0.067	1.45	1.70
E	0.195	0.205	4.95	5.21
F	0.045	0.055	1.14	1.40
G	0.195	0.205	4.95	5.21
H	0.280	0.360	7.11	9.14

- PIN 1. GATE
 PIN 2. DRAIN
 PIN 3. SOURCE

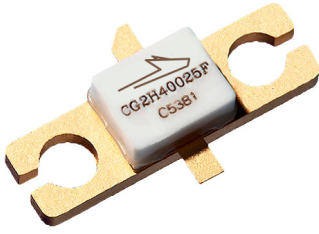

Product Ordering Information

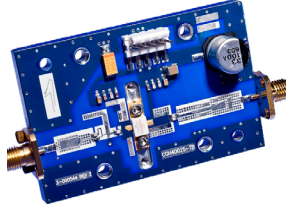
Order Number	Description	Unit of Measure	Image
CG2H40025F	GaN HEMT	Each	
CG2H40025P	GaN HEMT	Each	
CG2H40025F-AMP	Test board with GaN HEMT installed	Each	

**For more information, please contact:**

4600 Silicon Drive
Durham, NC 27703 USA
Tel: +1.919.313.5300
www.wolfspeed.com/RF

Sales Contact
RFSales@wolfspeed.com

RF Product Marketing Contact
RFMarketing@wolfspeed.com

Notes & Disclaimer

Specifications are subject to change without notice. “Typical” parameters are the average values expected by Wolfspeed in large quantities and are provided for information purposes only. Wolfspeed products are not warranted or authorized for use as critical components in medical, life-saving, or life-sustaining applications, or other applications where a failure would reasonably be expected to cause severe personal injury or death. No responsibility is assumed by Wolfspeed for any infringement of patents or other rights of third parties which may result from use of the information contained herein. No license is granted by implication or otherwise under any patent or patent rights of Wolfspeed.

© 2019-2022 Wolfspeed, Inc. All rights reserved. Wolfspeed® and the Wolfstreak logo are registered trademarks and the Wolfspeed logo is a trademark of Wolfspeed, Inc.
PATENT: <https://www.wolfspeed.com/legal/patents>

The information in this document is subject to change without notice.