

## L1008Q3R3MDMIT

Aliases (L1008Q3R3MDMIT)

Obsolete

KEMET, L-DMI, Power, 3.3 uH, 20%

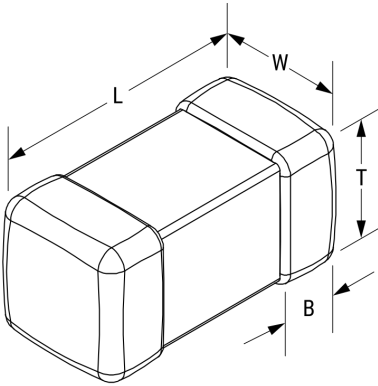

Click [here](#) for the 3D model.

### Dimensions

Chip Size	1008
L	2.5mm +/-0.2mm
W	2mm +/-0.2mm
T	1.2mm MAX
B	0.5mm +/-0.3mm

### Packaging Specifications

Packaging	T&R
Packaging Quantity	3000

### General Information

Series	L-DMI
Style	SMD Chip
Description	Shielded, Surface Mount Inductor
Features	High Current Type For Power Supply Line
RoHS	Yes
Winding Type	Multilayer
Notes	Suggested Replacement - <a href="https://www.chilisin.com/en-global/Inductor/Product/BKPB_252010/BKPB002520103R3MA2">https://www.chilisin.com/en-global/Inductor/Product/BKPB_252010/BKPB002520103R3MA2</a> .

### Specifications

Inductance	3.3 uH (1MHz)
Inductance Tolerance	20%
Temperature Range	-40/+85°C
Shielded	Yes
Current	1100 mAmps (MAX)
DC Resistance	0.15 Ohms (Max)