

Zener Voltage Regulators

200 mW Micro Packaged

NZD5V1MU Series

This Zener diode is designed to provide voltage regulation protection and is especially attractive in situations where space is at a premium. Because of its small size, it is suited for use in mobile applications.

Specification Features:

- Standard Zener Breakdown Voltage Range:
2.2 V to 9.1 V
- Steady State Power Rating of 200 mW
- Small Body Outline Dimensions:
0.60 mm x 0.30 mm
- Low Body Height: 0.30 mm
- ESD Rating of Class 3 (>8 kV) per Human Body Model
- These Devices are Pb-Free, Halogen Free/BFR Free and are RoHS Compliant

Mechanical Characteristics:

MOUNTING POSITION: Any

QUALIFIED MAX REFLOW TEMPERATURE: 260°C

Device Meets MSL 1 Requirements

MAXIMUM RATINGS

Rating	Symbol	Max	Unit
Total Device Dissipation FR-5 Board, (Note 1) @ $T_A = 25^\circ\text{C}$	P_D	200	mW
Thermal Resistance from Junction-to-Ambient	$R_{\theta JA}$	400	$^\circ\text{C}/\text{W}$
Junction and Storage Temperature Range	T_J, T_{stg}	-55 to +150	$^\circ\text{C}$
Lead Solder Temperature – Maximum (10 Second Duration)	T_L	260	$^\circ\text{C}$

Stresses exceeding those listed in the Maximum Ratings table may damage the device. If any of these limits are exceeded, device functionality should not be assumed, damage may occur and reliability may be affected.

1. FR-5 = 1.0 x 0.75 x 0.62 in.



ON Semiconductor®

www.onsemi.com

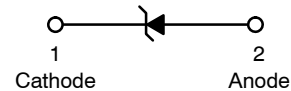

MARKING DIAGRAM



X3DFN2
CASE 152AF

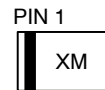

X = Specific Device Code
M = Month Code

ORDERING INFORMATION

Device	Package	Shipping†
NZDxxxMUT5G	X3DFN (Pb-Free)	10000 / Tape & Reel

†For information on tape and reel specifications, including part orientation and tape sizes, please refer to our Tape and Reel Packaging Specifications Brochure, BRD8011/D.

DEVICE MARKING INFORMATION

See specific marking information in the device marking column of the Electrical Characteristics tables starting on page 3 of this data sheet.

NZD5V1MU Series

ELECTRICAL CHARACTERISTICS

($T_A = 25^\circ\text{C}$ unless otherwise noted,
 $V_F = 1.1\text{ V Max. @ } I_F = 10\text{ mA}$ for all types)

Symbol	Parameter
V_Z	Reverse Zener Voltage @ I_{ZT}
I_{ZT}	Reverse Current
Z_{ZT}	Maximum Zener Impedance @ I_{ZT}
I_{ZK}	Reverse Current
Z_{ZK}	Maximum Zener Impedance @ I_{ZK}
I_R	Reverse Leakage Current @ V_R
V_R	Reverse Voltage
I_F	Forward Current
V_F	Forward Voltage @ I_F
Θ_{VZ}	Maximum Temperature Coefficient of V_Z
C	Max. Capacitance @ $V_R = 0$ and $f = 1\text{ MHz}$

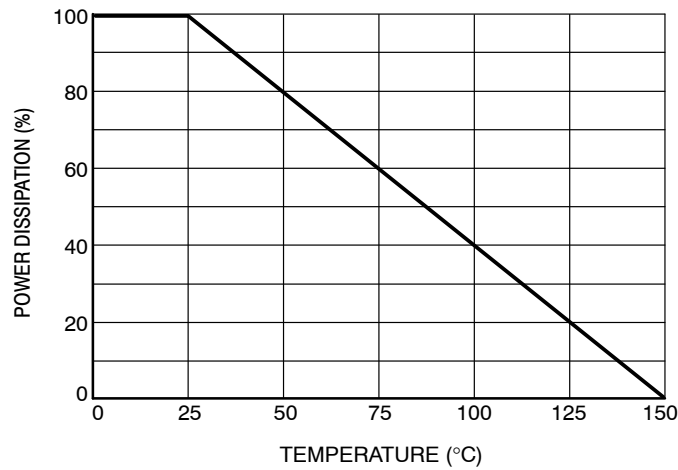
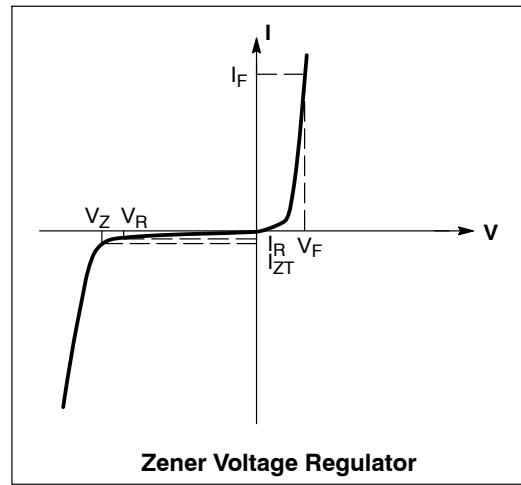

Figure 1. Steady State Power Derating

NZD5V1MU Series

ELECTRICAL CHARACTERISTICS ($T_A = 25^\circ\text{C}$ unless otherwise noted, $V_F = 1.1\text{ V Max.}$ @ $I_F = 10\text{ mA}$ for all types)

Device	Device Marking	Zener Voltage (Note 1)			Zener Impedance			Leakage Current		Θ_{VZ} (mV/k) @ I_{ZT}		C @ $V_R = 0$ f = 1 MHz
		V_Z (Volts)		@ I_{ZT}	Z_{ZT} @ I_{ZT}	Z_{ZK} @ I_{ZK}		I_R @ V_R				
		Min	Max	mA	Ω	Ω	mA	μA	Volts	Min	Max	pF
NZD2V2MUT5G	K*	2.08	2.30	4	100	1000	1	50	1	-3.5	0	210
NZD2V4MUT5G	D***	2.28	2.52	5	100	1000	1	50	1	-3.5	0	210
NZD2V7MUT5G	E***	2.57	2.84	5	100	1000	1	20	1	-3.5	0	210
NZD3V0MUT5G	Q*	2.85	3.15	5	100	1000	1	10	1	-3.5	0	210
NZD3V3MUT5G	F***	3.14	3.47	5	100	1000	1	10	1	-3.5	0	210
NZD3V6MUT5G	J***	3.42	3.78	5	100	1000	1	10	1	-3.5	0	210
NZD3V9MUT5G	L	3.71	4.10	5	100	1000	1	5	1	-3.5	-2.5	210
NZD4V3MUT5G	D**	4.09	4.52	5	100	1000	1	5	1	-3.5	0	210
NZD4V7MUT5G	P	4.47	4.94	5	100	800	0.5	2	1	-3.5	0.2	150
NZD5V1MUT5G	Q	4.85	5.36	5	80	500	0.5	2	1.5	-2.7	1.2	130
NZD5V6MUT5G	R	5.32	5.88	5	60	200	0.5	1	2.5	-2.0	2.5	115
NZD6V2MUT5G	T	5.89	6.51	5	60	100	0.5	1	3.0	0.4	3.7	110
NZD6V8MUT5G	K***	6.46	7.14	5	40	60	0.5	0.5	3.5	1.2	4.5	105
NZD7V5MUT5G	L***	7.13	7.88	5	30	60	0.5	0.5	4.0	2.5	5.3	100
NZD8V2MUT5G	2	7.79	8.61	5	30	60	0.5	0.5	5.0	3.2	6.2	90
NZD9V1MUT5G	E**	8.65	9.56	5	30	60	0.5	0.5	6.0	3.8	7.0	80

*Rotated 90° .

**Rotated 180° .

***Rotated 270° .

1. Zener voltage is measured with a pulse test current I_Z at an ambient temperature of 25°C .

MECHANICAL CASE OUTLINE

PACKAGE DIMENSIONS



X3DFN2, 0.62x0.32, 0.355P, (0201)
CASE 152AF
ISSUE B

SCALE 8:1

DATE 13 JAN 2023

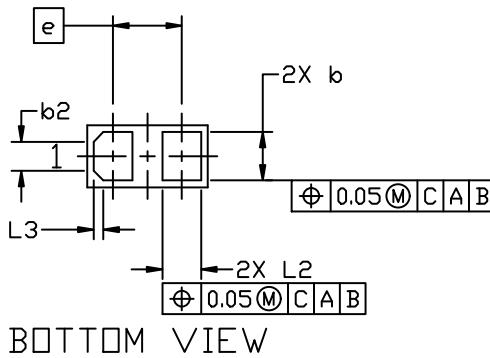
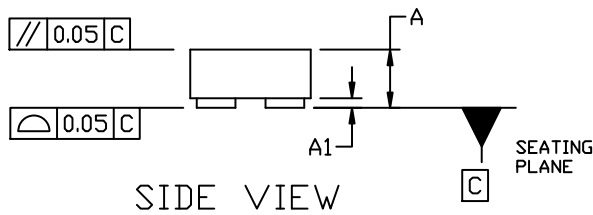
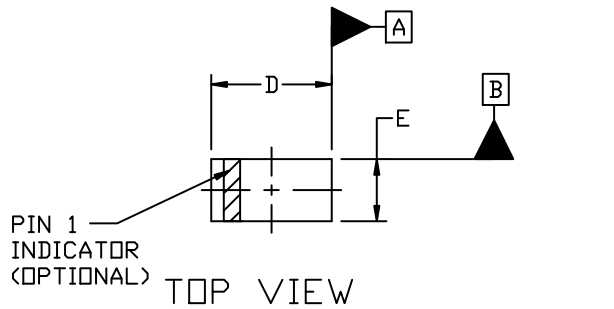

NOTES:

1. DIMENSIONING AND TOLERANCING PER ASME Y14.5M, 1994.
2. CONTROLLING DIMENSION: MILLIMETERS

DIM	MILLIMETERS		
	MIN.	NOM.	MAX.
A	0.25	0.29	0.33
A1	0.00	---	0.05
b	0.22	0.25	0.28
b2	0.150 REF		
D	0.58	0.62	0.66
E	0.28	0.32	0.36
e	0.355 BSC		
L2	0.17	0.20	0.23
L3	0.050 REF		

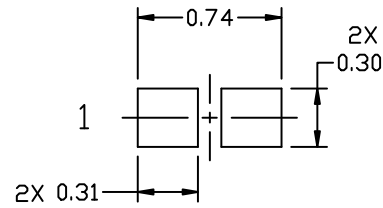

RECOMMENDED MOUNTING FOOTPRINT*

* For additional information on our Pb-Free strategy and soldering details, please download the ON Semiconductor Soldering and Mounting Techniques Reference Manual, SOLDERRM/D.

GENERIC MARKING DIAGRAM*

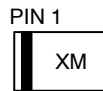

X = Specific Device Code
M = Date Code

*This information is generic. Please refer to device data sheet for actual part marking. Pb-Free indicator, "G" or microdot "▪", may or may not be present. Some products may not follow the Generic Marking.

DOCUMENT NUMBER:	98AON56472E	Electronic versions are uncontrolled except when accessed directly from the Document Repository. Printed versions are uncontrolled except when stamped "CONTROLLED COPY" in red.
DESCRIPTION:	X3DFN2, 0.62X0.32, 0.355P, (0201)	PAGE 1 OF 1

onsemi and ONSEMI are trademarks of Semiconductor Components Industries, LLC dba onsemi or its subsidiaries in the United States and/or other countries. onsemi reserves the right to make changes without further notice to any products herein. onsemi makes no warranty, representation or guarantee regarding the suitability of its products for any particular purpose, nor does onsemi assume any liability arising out of the application or use of any product or circuit, and specifically disclaims any and all liability, including without limitation special, consequential or incidental damages. onsemi does not convey any license under its patent rights nor the rights of others.

onsemi, **Onsemi**, and other names, marks, and brands are registered and/or common law trademarks of Semiconductor Components Industries, LLC dba "**onsemi**" or its affiliates and/or subsidiaries in the United States and/or other countries. **onsemi** owns the rights to a number of patents, trademarks, copyrights, trade secrets, and other intellectual property. A listing of **onsemi**'s product/patent coverage may be accessed at www.onsemi.com/site/pdf/Patent-Marking.pdf. **onsemi** reserves the right to make changes at any time to any products or information herein, without notice. The information herein is provided "as-is" and **onsemi** makes no warranty, representation or guarantee regarding the accuracy of the information, product features, availability, functionality, or suitability of its products for any particular purpose, nor does **onsemi** assume any liability arising out of the application or use of any product or circuit, and specifically disclaims any and all liability, including without limitation special, consequential or incidental damages. Buyer is responsible for its products and applications using **onsemi** products, including compliance with all laws, regulations and safety requirements or standards, regardless of any support or applications information provided by **onsemi**. "Typical" parameters which may be provided in **onsemi** data sheets and/or specifications can and do vary in different applications and actual performance may vary over time. All operating parameters, including "Typicals" must be validated for each customer application by customer's technical experts. **onsemi** does not convey any license under any of its intellectual property rights nor the rights of others. **onsemi** products are not designed, intended, or authorized for use as a critical component in life support systems or any FDA Class 3 medical devices or medical devices with a same or similar classification in a foreign jurisdiction or any devices intended for implantation in the human body. Should Buyer purchase or use **onsemi** products for any such unintended or unauthorized application, Buyer shall indemnify and hold **onsemi** and its officers, employees, subsidiaries, affiliates, and distributors harmless against all claims, costs, damages, and expenses, and reasonable attorney fees arising out of, directly or indirectly, any claim of personal injury or death associated with such unintended or unauthorized use, even if such claim alleges that **onsemi** was negligent regarding the design or manufacture of the part. **onsemi** is an Equal Opportunity/Affirmative Action Employer. This literature is subject to all applicable copyright laws and is not for resale in any manner.

ADDITIONAL INFORMATION

TECHNICAL PUBLICATIONS:

Technical Library: www.onsemi.com/design/resources/technical-documentation
onsemi Website: www.onsemi.com

ONLINE SUPPORT: www.onsemi.com/support

For additional information, please contact your local Sales Representative at www.onsemi.com/support/sales