

REV.	ECN NO.	DATE	SIGN	DESCRIPTION
B	LE3-960042	2009/06/22	Prune	Change The Note And 螺牙

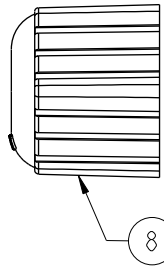

Sealing Nut



Seals

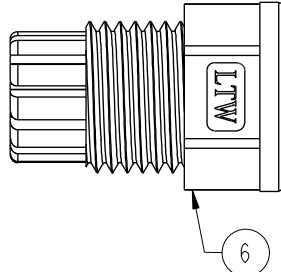

Clamp Ring



Gasket

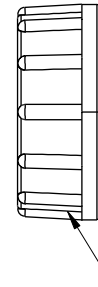

Lock Nut

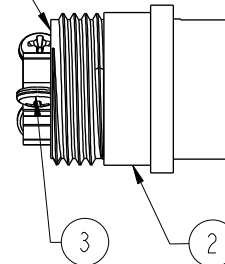

Screw

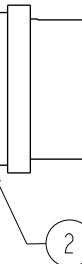

Connector

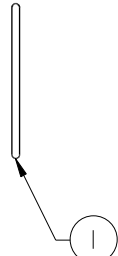

O-ring

With Liquid Glue

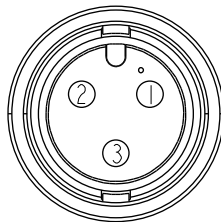
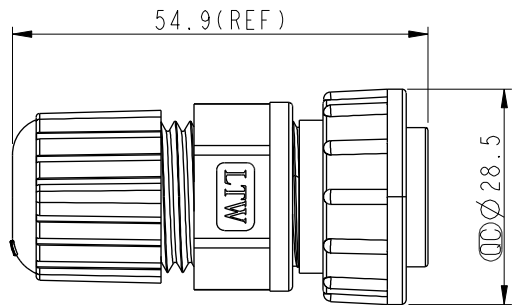

Pin Assignments
Front View

ALTW
CONFIDENTIAL
2012-05-04
R&D DEPT.

ALTW
DCC. DEPT.
CONFIDENTIAL
2012-06-27
ISSUED

Note:

- * (∅) Important Dimension To Check.
- * Waterproof Rate: IP67
- * Housing: Black, Nylon+GF
- * Pin: Copper Alloy, Gold Plated
- * Liquid Glue: Clear
- * Screw: Stainless Steel
- * Ring: Black, EPDM
- * Nut: Black, Nylon+GF
- * Gasket: Black, Silicone
- * Clamping Ring: Black, Nylon
- * Seals: Black, EPDM
- * Sealing Nut: Black, Nylon
- * PE Bag: 90*85mm
- * Seal For Cable OD: $\varnothing 5.5\text{mm} \sim 10.8\text{mm}$
- * One Set Unassembled In One PE Bag
- * Application AWG: 14~16AWG

PE Pag (9)

UNIT: mm

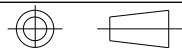

TOLERANCE
.X ±0.25
.XX ±0.1
.XXX ±0.05
ANGLES ±1°

TITLE Large Assy Lock 3Pin F Conn F Pin			
SCALE 1:1	SIZE A4	SHEET 1 OF 1	
REV. B	WC-REV. A.2	∅: Inspection item	

Amphenol LTW
安費諾亮泰企業股份有限公司

ITEM NO. DC-03BFFB-LL7001	DRAWN BY SamChang	DATE 2012-05-04
DWG NO. DC-03BFFB-LL7001	CHECKED BY Jeffrey	DATE 2012-06-27
CUSTOMER ALTW	APPROVED BY Lion	DATE 2012-06-27

THIS DOCUMENT IS SUBJECT TO CHANGE WITHOUT NOTICE. IT IS CONFIDENTIAL AND A PROPERTY OF AMPHENOL LTW. DISCLOSURE TO THIRD PARTY HAS TO BE AUTHORIZED BY AMPHENOL LTW.