

■ Features

- Constant Voltage + Constant Current mode output
- Wide input range 110-305VAC with PFC function
- Compliance with BS EN/EN61347 regulation
- Class 2/ II power unit (Except for 12V)
- Slim and Linear housing Design
- No load power consumption <0.5W
- 3 years warranty

■ Applications

- Panel lighting
- Strip lighting
- Decoration lighting
- Troffer lighting
- Signage and display
- Cove lighting

■ GTIN CODE

MW Search: <https://www.meanwell.com/serviceGTIN.aspx>

■ Description

SLD-80 series is a 80W AC/DC LED driver featuring the dual modes constant voltage and constant current output. SLD-80 operates from 110~305VAC and offers models with different rated voltage ranging between 12V and 56V. Thanks to the high efficiency up to 92%, with the fanless design, the entire series is able to operate for -20°C ~ +90°C case temperature under free air convection. SLD-80 design with low profile and linear housing which is good for signage and linear luminaire applications.

■ Model Encoding

SLD - 80 - 24

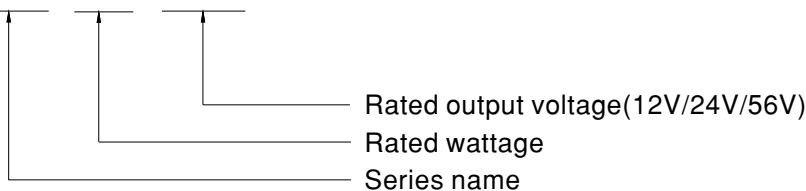

SPECIFICATION

MODEL	SLD-80-12	SLD-80-24		
OUTPUT	DC VOLTAGE	12V	24V	
	CONSTANT CURRENT REGION <small>Note.2</small>	8.4~12V	16.8 ~24V	
	RATED CURRENT	6.6A	3.3A	
	RATED POWER <small>Note.5</small>	79.2W	79.2W	
	RIPPLE & NOISE (max.) <small>Note.3</small>	150mVp-p	240mVp-p	
	VOLTAGE TOLERANCE <small>Note.4</small>	±4.0%	±3.0%	
	LINE REGULATION	±0.5%	±0.5%	
	LOAD REGULATION	±1.5%	±0.5%	
	SETUP, RISE TIME <small>Note.6</small>	500ms, 80ms 115VAC / 230VAC		
HOLD UP TIME (Typ.)	10ms/230VAC 10ms/115VAC			
INPUT	VOLTAGE RANGE <small>Note.5</small>	110~ 305VAC 155~ 431VDC (Please refer to "STATIC CHARACTERISTIC" section)		
	FREQUENCY RANGE	47 ~ 63Hz		
	POWER FACTOR	PF ≥ 0.97/115VAC, PF ≥ 0.95/230VAC, PF ≥ 0.92/277VAC@full load (Please refer to "POWER FACTOR (PF) CHARACTERISTIC" section)		
	TOTAL HARMONIC DISTORTION	THD< 10%(@load≥60%/115VC,230VAC; @load≥75%/277VAC) (Please refer to "TOTAL HARMONIC DISTORTION(THD)" section)		
	EFFICIENCY (Typ.)	90.5%	91.5%	
	AC CURRENT	0.9A / 115VAC 0.45A / 230VAC 0.38A/277VAC		
	INRUSH CURRENT(Typ.)	COLD START 50A(twidth=270µs measured at 50% Ipeak) at 230VAC; Per NEMA 410		
	MAX. No. of PSUs on 16A CIRCUIT BREAKER	8 units (circuit breaker of type B) / 16 units (circuit breaker of type C) at 230VAC		
	LEAKAGE CURRENT	<0.25mA / 277VAC		
NO LOAD POWER CONSUMPTION	<0.5W			
PROTECTION	OVER CURRENT	95 ~ 108% Constant current limiting or Hiccup mode, recovers automatically after fault condition is removed		
	SHORT CIRCUIT	Hiccup mode, recovers automatically after fault condition is removed		
	OVER VOLTAGE	14 ~ 17V	28 ~ 34V	
	OVER TEMPERATURE	Shut down output voltage, re-power on to recovery		
ENVIRONMENT	WORKING TEMP.	Tcase=-20 ~ +90°C (Please refer to " OUTPUT LOAD vs TEMPERATURE" section)		
	MAX. CASE TEMP.	Tcase=+90°C		
	WORKING HUMIDITY	20 ~ 95% RH non-condensing		
	STORAGE TEMP.	-40 ~ +80°C		
	TEMP. COEFFICIENT	±0.03%/°C (0 ~ 50°C)		
	VIBRATION	10 ~ 500Hz, 2G 12min./1cycle, period for 72min. each along X, Y, Z axes		
SAFETY & EMC	SAFETY STANDARDS <small>Note.8</small>	UL8750, CSA C22.2 No. 250.13-12, ENEC BS EN/EN61347-1, BS EN/EN61347-2-13 independent, BS EN/EN62384, EAC TP TC 004, GB19510.1,GB19510.14, IS15885(Part2/Sec13) approved		
	WITHSTAND VOLTAGE	I/P-O/P:3.75KVAC		
	ISOLATION RESISTANCE	I/P-O/P:100M Ohms / 500VDC / 25°C / 70% RH		
	EMC EMISSION <small>Note.8</small>	Parameter	Standard	Test Level/Note
		Conducted	BS EN/EN55015(CISPR15) ,GB/T17743	-----
		Radiated	BS EN/EN55015(CISPR15) ,GB/T17743	-----
		Harmonic Current	BS EN/EN61000-3-2 ,GB/T17625.1	Class C @load≥60%
	EMC IMMUNITY	Voltage Flicker	BS EN/EN61000-3-3	-----
		BS EN/EN61547		
		Parameter	Standard	Test Level/Note
ESD		BS EN/EN61000-4-2	Level 3, 8KV air ; Level 2, 4KV contact	
Radiated		BS EN/EN61000-4-3	Level 2	
EFT/Burst		BS EN/EN61000-4-4	Level 2	
Surge		BS EN/EN61000-4-5	1KV/Line-Line	
Conducted	BS EN/EN61000-4-6	Level 2		
	Magnetic Field	BS EN/EN61000-4-8	Level 2	
	Voltage Dips and Interruptions	BS EN/EN61000-4-11	>95% dip 0.5 periods, 30% dip 25 periods, >95% interruptions 250 periods	
OTHERS	MTBF	2666.8K hrs min. Telcordia SR-332 (Bellcore) ; 260.9K hrs min. MIL-HDBK-217F (25°C)		
	DIMENSION	320*30*16.8mm (L*W*H)		
	PACKING	0.206 Kg; 64pcs / 14.184Kg / 0.75CUFT		
NOTE	<p>1. All parameters NOT specially mentioned are measured at 230VAC input, rated current and 25°C of ambient temperature.</p> <p>2. Please refer to "DRIVING METHODS OF LED MODULE".</p> <p>3. Ripple & noise are measured at 20MHz of bandwidth by using a 12" twisted pair-wire terminated with a 0.1uf & 47uf parallel capacitor.</p> <p>4. Tolerance : includes set up tolerance, line regulation and load regulation.</p> <p>5. De-rating may be needed under low input voltages. Please refer to "STATIC CHARACTERISTIC" sections for details.</p> <p>6. Length of set up time is measured at first cold start. Turning ON/OFF the driver may lead to increase of the set up time.</p> <p>7. The driver is considered as a component that will be operated in combination with final equipment. Since EMC performance will be affected by the complete installation, the final equipment manufacturers must re-quality EMC Directive on the complete installation again.</p> <p>8. This series meets the typical life expectancy of 30000 hours of operation when Tcase, particularly (Tc) point (or TMP, per DLC), is about 75°C or less.</p> <p>9. Please refer to the warranty statement on MEAN WELL's website at http://www.meanwell.com</p> <p>10. RCM is on a voluntary basis. Non IC classification Independent LED control gear is not suitable for residential installations but recommend to be used for commercial decoration/sign board/Luminaire lighting purpose.</p> <p>11. The ambient temperature derating of 3.5°C/1000m with fanless models and of 5°C/1000m with fan models for operating altitude higher than 2000m(6500ft).</p> <p>※ Product Liability Disclaimer : For detailed information, please refer to https://www.meanwell.com/serviceDisclaimer.aspx</p>			

SPECIFICATION

MODEL		SLD-80-56			
OUTPUT	RATED CURRENT	1400mA			
	RATED POWER <small>Note.2</small>	78.4W			
	CONSTANT CURRENT REGION <small>Note.3</small>	30 ~ 56V			
	FULL POWER CURRENT RANGE	1400~2100mA			
	OPEN CIRCUIT VOLTAGE (max.)	60V			
	CURRENT ADJ. RANGE	700~2100mA			
	CURRENT RIPPLE	5.0%(@rated current)			
	CURRENT TOLERANCE	±5%			
	SET UP TIME <small>Note.5</small>	500ms/230VAC, 1200ms/115VAC			
INPUT	VOLTAGE RANGE <small>Note.2</small>	110 ~ 305VAC 155VDC ~ 431VDC (Please refer to "STATIC CHARACTERISTIC" and "DRIVING METHODS OF LED MODULE" section)			
	FREQUENCY RANGE	47 ~ 63Hz			
	POWER FACTOR (Typ.)	PF ≥ 0.97 / 115VAC, PF ≥ 0.95 / 230VAC, PF ≥ 0.92 / 277VAC at full load (Please refer to "Power Factor Characteristic" section)			
	TOTAL HARMONIC DISTORTION	THD < 10% (@ load ≥ 60% at 115VAC/230VAC, @load ≥ 75% at 277VAC) Please refer to "TOTAL HARMONIC DISTORTION (THD)" section			
	EFFICIENCY (Typ.)	92.0%			
	AC CURRENT (Typ.)	0.9A / 115VAC 0.45A / 230VAC 0.38A / 277VAC			
	INRUSH CURRENT(Typ.)	COLD START 50A(twidth=270µs measured at 50% I _{peak}) at 230VAC; Per NEMA 410			
	MAX. NO. of PSUs on 16A CIRCUIT BREAKER	8 unit(circuit breaker of type B) / 16 units(circuit breaker of type C) at 230VAC			
	LEAKAGE CURRENT	<0.25mA / 277VAC			
	NO LOAD POWER CONSUMPTION	<0.5W			
PROTECTION	OVER POWER	110 ~ 150% Hiccup mode, recovers automatically after fault condition is removed			
	SHORT CIRCUIT	Hiccup mode, recovers automatically after fault condition is removed			
	OVER VOLTAGE	60 ~ 70V Shut down output voltage, re-power on to recovery			
	OVER TEMPERATURE	Shut down output voltage, re-power on to recovery			
ENVIRONMENT	WORKING TEMP.	T _{case} = -20 ~ +90°C (Please refer to "OUTPUT LOAD vs TEMPERATURE" section)			
	MAX. CASE TEMP.	T _{case} = +90°C			
	WORKING HUMIDITY	20 ~ 95% RH non-condensing			
	STORAGE TEMP.	-40 ~ +80°C			
	TEMP. COEFFICIENT	±0.03%/°C (0 ~ 60°C)			
	VIBRATION	10 ~ 500Hz, 2G 12min./1cycle, period for 72min. each along X, Y, Z axes			
SAFETY & EMC	SAFETY STANDARDS <small>Note.4</small>	UL8750, CSA C22.2 No. 250.13-12, ENEC BS EN/EN61347-1, BS EN/EN61347-2-13 independent, BS EN/EN62384, EAC TP TC 004, GB19510.1, GB19510.14, IS15885(Part2/Sec13) approved			
	WITHSTAND VOLTAGE	I/P-O/P:3.75KVAC			
	ISOLATION RESISTANCE	I/P-O/P:100M Ohms / 500VDC / 25°C / 70% RH			
	EMC EMISSION <small>Note.4</small>	Parameter	Standard	Test Level/Note	
		Conducted	BS EN/EN55015(CISPR15), GB/T17743	-----	
		Radiated	BS EN/EN55015(CISPR15), GB/T17743	-----	
		Harmonic Current	BS EN/EN61000-3-2, GB/T17625.1	Class C @load ≥ 60%	
		Voltage Flicker	BS EN/EN61000-3-3	-----	
	EMC IMMUNITY	BS EN/EN61547			
		Parameter	Standard	Test Level/Note	
		ESD	BS EN/EN61000-4-2	Level 3, 8KV air ; Level 2, 4KV contact	
Radiated		BS EN/EN61000-4-3	Level 2		
EFT/Burst		BS EN/EN61000-4-4	Level 2		
Surge		BS EN/EN61000-4-5	1KV/Line-Line		
Conducted		BS EN/EN61000-4-6	Level 2		
Magnetic Field		BS EN/EN61000-4-8	Level 2		
	Voltage Dips and Interruptions	BS EN/EN61000-4-11	>95% dip 0.5 periods, 30% dip 25 periods, >95% interruptions 250 periods		
OTHERS	MTBF	2666.8K hrs min. Telcordia SR-332 (Bellcore) ; 260.9K hrs min. MIL-HDBK-217F (25°C)			
	DIMENSION	320*30*16.8mm (L*W*H)			
	PACKING	0.206 Kg; 64pcs / 14.184Kg / 0.75CUFT			
NOTE	<p>1. All parameters NOT specially mentioned are measured at 230VAC input, rated current and 25°C of ambient temperature.</p> <p>2. De-rating may be needed under low input voltages. Please refer to "STATIC CHARACTERISTIC" sections for details.</p> <p>3. Please refer to "DRIVING METHODS OF LED MODULE".</p> <p>4. This series meets the typical life expectancy of 30000 hours of operation when T_{case}, particularly (t_c) point (or TMP, per DLC), is about 75°C or less.</p> <p>5. Length of set up time is measured at first cold start. Turning ON/OFF the driver may lead to increase of the set up time.</p> <p>6. The driver is considered as a component that will be operated in combination with final equipment. Since EMC performance will be affected by the complete installation, the final equipment manufacturers must re-qualify EMC Directive on the complete installation again.</p> <p>7. Ripple & noise are measured at 20MHz of bandwidth by using a 12" twisted pair-wire terminated with a 0.1µf & 47µf parallel capacitor.</p> <p>8. Please refer to the warranty statement on MEAN WELL's website at http://www.meanwell.com</p> <p>9. The ambient temperature derating of 3.5°C/1000m with fanless models and of 5°C/1000m with fan models for operating altitude higher than 2000m(6500ft).</p> <p>10. RCM is on a voluntary basis. Non IC classification Independent LED control gear is not suitable for residential installations but recommend to be used for commercial decoration/sign board/Luminaire lighting purpose.</p> <p>※ Product Liability Disclaimer : For detailed information, please refer to https://www.meanwell.com/serviceDisclaimer.aspx File Name:SLD-80-SPEC 2022-12-30</p>				

■ BLOCK DIAGRAM

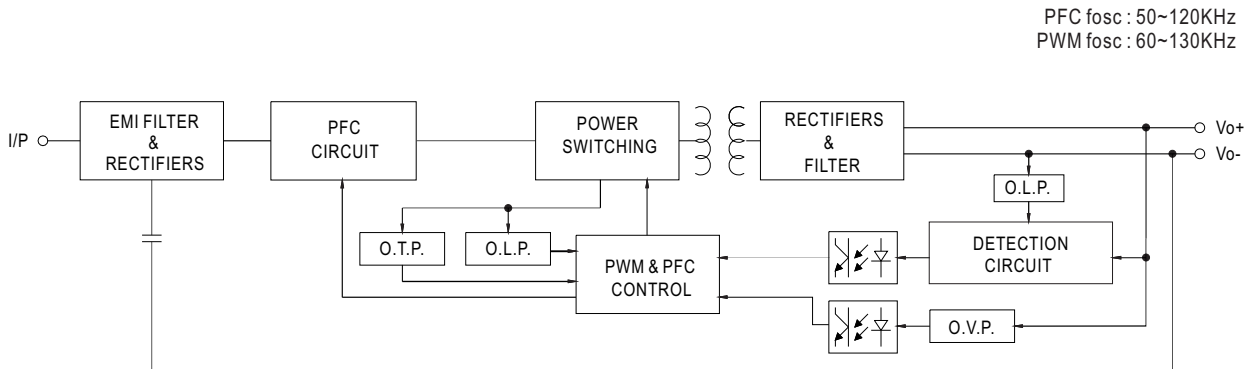

■ DRIVING METHODS OF LED MODULE

◎ SLD-80-12,24

✘ This series is able to work in either Constant Current mode (a direct drive way) or Constant Voltage mode (usually through additional DC/DC driver) to drive the LEDs.

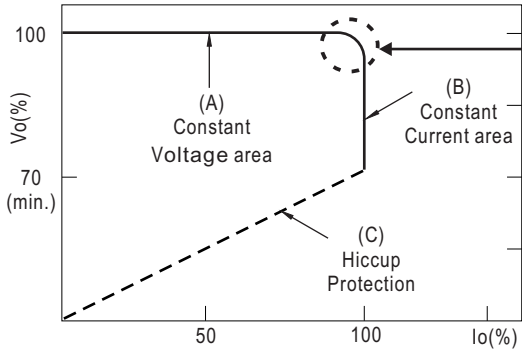

In the constant current region, the highest voltage at the output of the driver depends on the configuration of the end systems.
Should there be any compatibility issues, please contact MEAN WELL.

Typical output current normalized by rated current (%)

◎ SLD-80-56

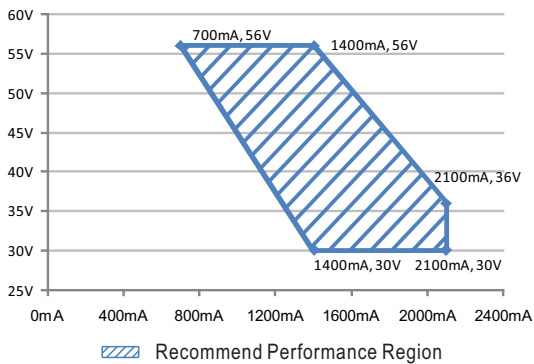

OUTPUT LOAD vs TEMPERATURE

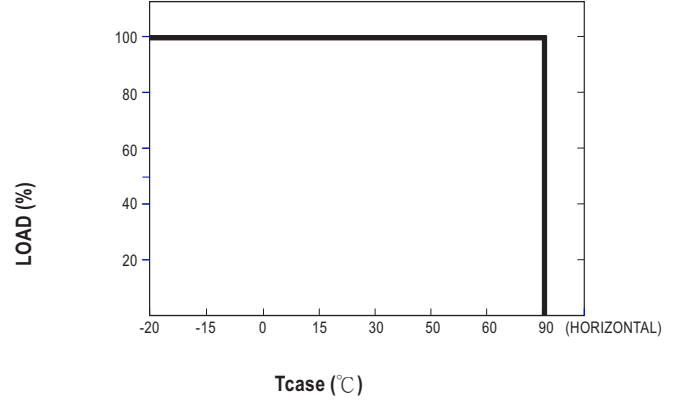
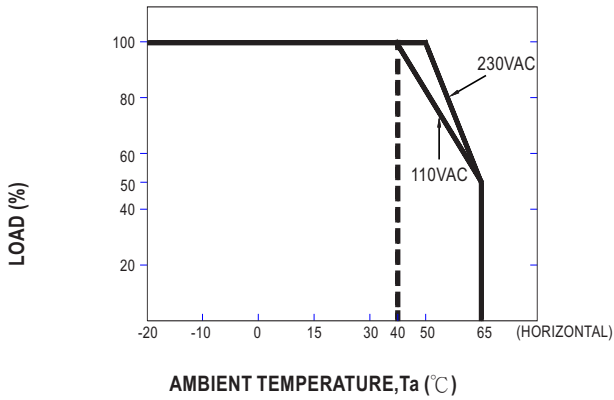

STATIC CHARACTERISTIC

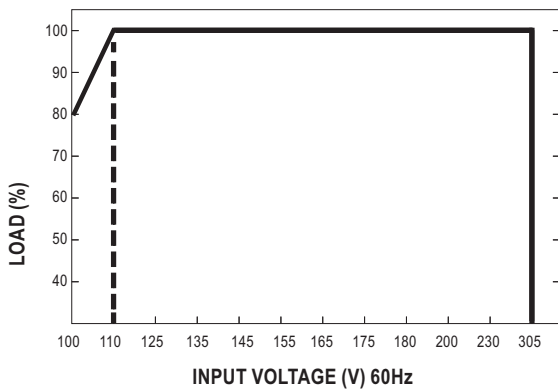

※ De-rating is needed under low input voltage.

POWER FACTOR (PF) CHARACTERISTIC

※ 24V Model, Tcase at 75°C

Constant Current Mode

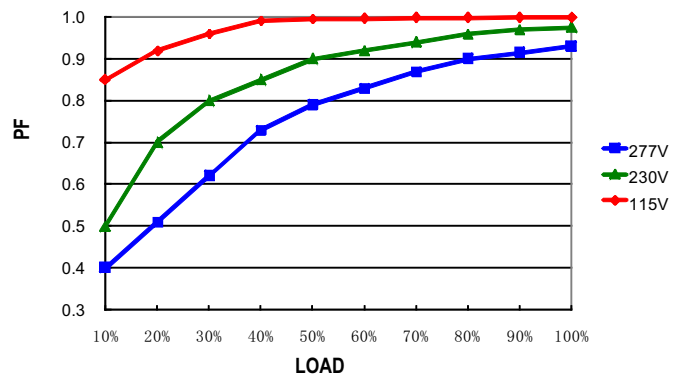

TOTAL HARMONIC DISTORTION (THD)

※ 24V Model, Tcase at 75°C

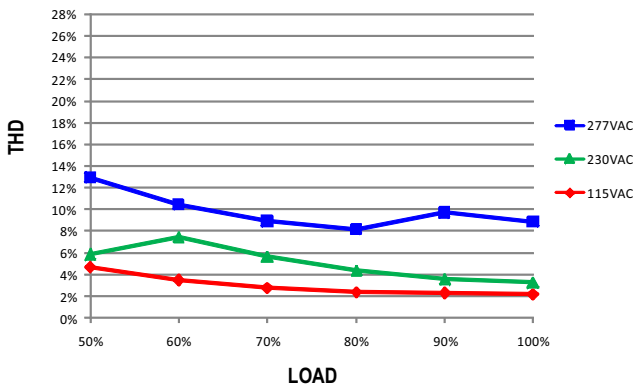

EFFICIENCY vs LOAD

SLD-80 series possess superior working efficiency that up to 91.5% can be reached in field applications.

※ 24V Model, Tcase at 75°C

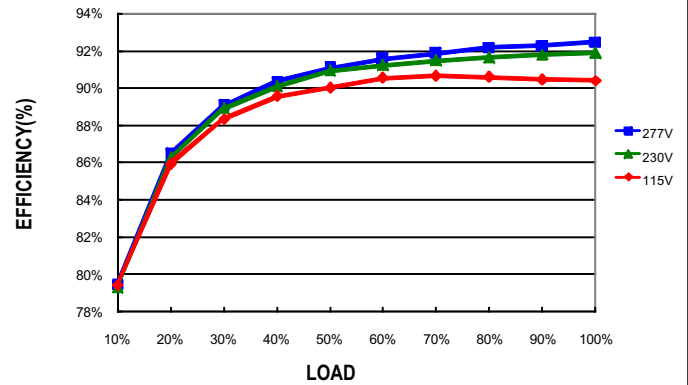

■ LIFE TIME

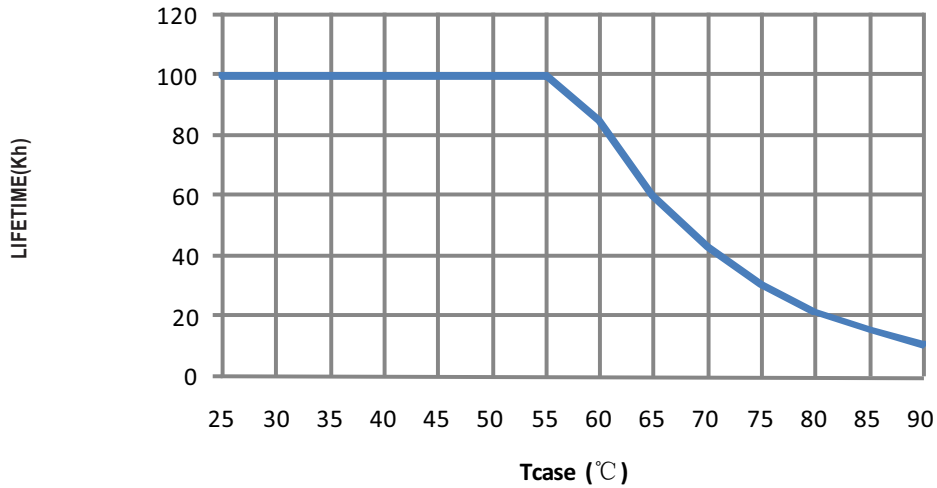

■ Mechanical Specification

Unit:mm

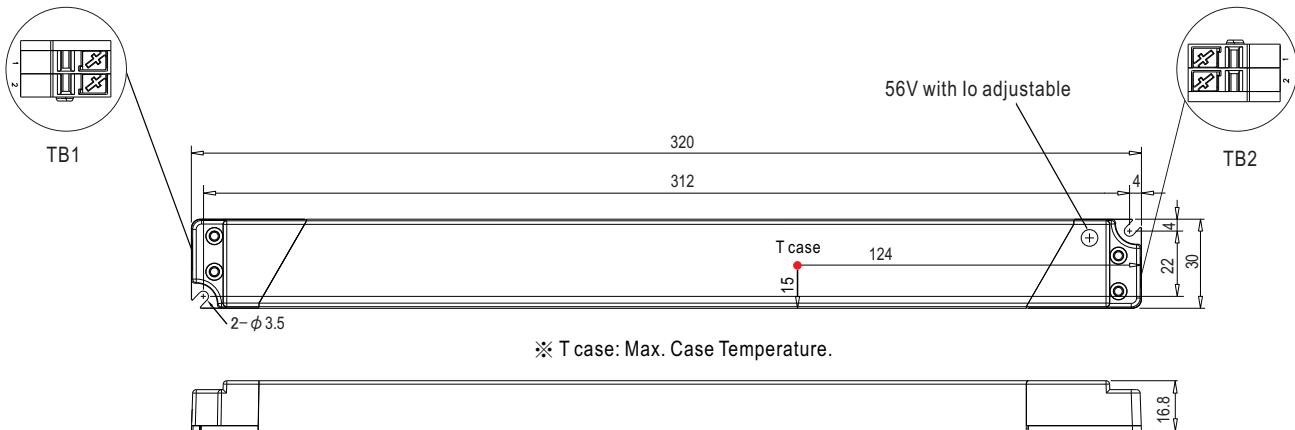

TB1 wiring:

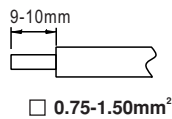

Terminal Pin No. Assignment (TB1) :
DEGSON DG219-3.5(GRAY)

Pin No.	Assignment
1	AC/L
2	AC/N

TB2 wiring:

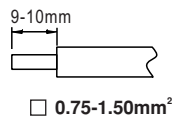

Terminal Pin No. Assignment (TB2) :
DEGSON DG219-3.5(RED/BLACK)

Pin No.	Assignment
1	+V
2	-V

■ INSTALLATION MANUAL

Please refer to : <http://www.meanwell.com/manual.html>