

ITEM NO.	PART NUMBER	DESCRIPTION	QTY.	COMPONENT NOTES
1	50-00595	Connector, dc plug, 5.5x2.5xL20.5mm, brass nickel plated	2	
2	30-00690	Wire, 2C TS, 22 AWG, UL2464, 300V, 80C, 4.30 mm, VW-1, PVC, white	1	
3	24-00161	Overmold, dc plug, twistlock, PVC	2	white

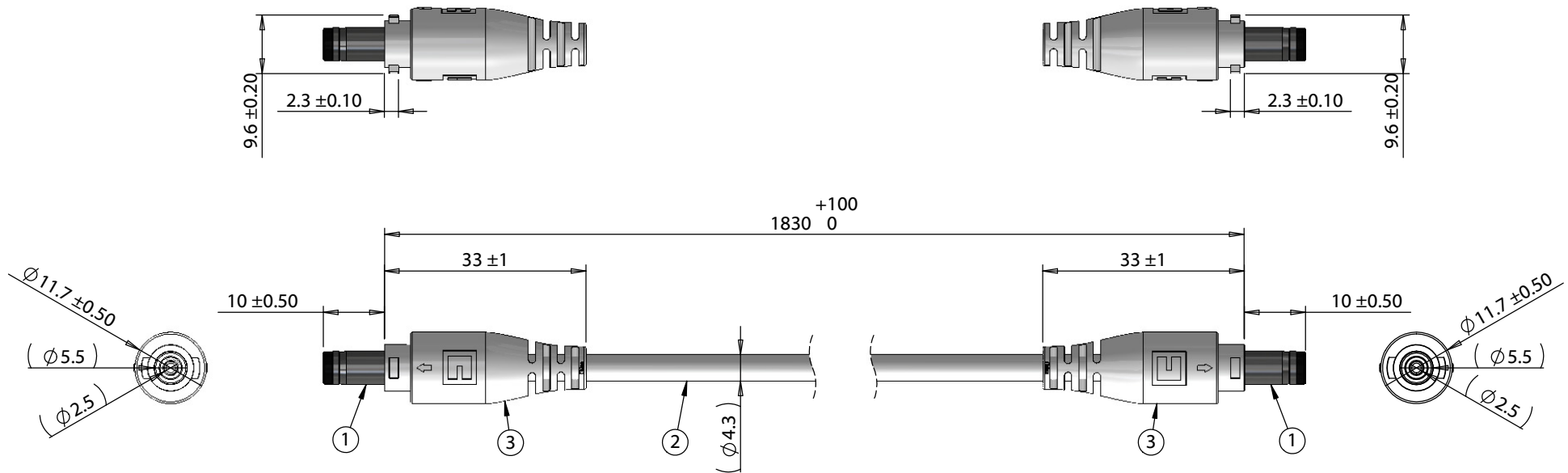

**Notes:**  
Plugs mate with cable assembly: 10-02941 & 10-02981  
Functionally equivalent components may be substituted

Wiring Diagram		
50-00595	wire color	50-00595
center	red	center
sleeve	black	sleeve

Revision:	Date:	Description:	Prepared:	Notes: RoHS compliant Function test: no open, no short circuit, no intermittent	<h1>TENSILITY</h1> <p>tel 1.541.323.3228 800 877.670.7118  fax 1.541.323.4202 web tensility.com</p>
A	11/7/2019	Initial release	Verified:		
			Dimensions are in millimeters. Tolerances: X: ± 0.5 mm X.X: ± 0.3 mm X.XX: ± 0.05 mm	Description: Cable, 1830 mm, 5.5x2.5mm 50-00595 dc plug twist lock to same, 22 AWG, white	Size: A Part number: 10-03626
					Scale: 1:1  Sheet 1 of 1

5

4

3

2

1