

Implementing All-in-One PC Power Supply Evaluation Board User's Manual

PC Power Supply with the NCP1399, NCP1602, NCP4305, NCP4810 and NCP431



ON Semiconductor®

www.onsemi.com

Eval Board User's Manual

Table 1. GENERAL PARAMETERS

Devices	Applications	Input Voltage	Output Power	Topology	Board Size
NCP1399 NCP1602 NCP4305 NCP4810 NCP431	AOI, Server Power	85 – 260 V _{AC}	240 W	CRM PFC & LLC	194 × 108 × 27 mm 7.11 W/inch ³
Output Voltage	V _{OUT} Ripple	Efficiency	Operating Temperature	Cooling	Standby Power
12 V/20 A (22 A Curr. Limit)	< 150 mV 2 to 20 A Load Steps	Above 89% @ I _{LOAD} > 8 A	0–40°C	Convection Open Frame, Forced in Frame	< 135 mW

Description

This evaluation board user's manual provides basic information about a high efficiency, low no-load power consumption reference design that was tailored to power All-in-One PC or similar type of equipment that accepts 12 V_{DC} on the input. The power supply implements PFC front stage to assure unity power factor and low THD, current mode LLC power stage to enhance transient response and secondary side synchronous rectification to maximize efficiency. This design note focuses mainly on the NCP1399 current mode LLC controller description – please refer to NCP1602 and NCP4305 materials to gain more information about these devices.

The NCP1399 is a current mode LLC controller which means that the operating frequency of an LLC converter is not controlled via voltage (or current) controlled oscillator but is directly derived from the resonant capacitor voltage signal and actual feedback level. This control technique brings several benefits compare to traditional voltage mode controllers like improved line and load transient response and inherent out of zero voltage switching protection. The LLC controller also features built-in high voltage startup and PFC operation control pins that ease implementation of a power supply with PFC front stage and no standby power supply on board. The enhanced light load operation scheme of the LLC controller allows SMPS design to fulfill the latest no-load and light load consumption limits and still keep output voltage regulated with excellent transient response from no-load to full-load steps.

Key Features

- Wide Input Voltage Range
- High Efficiency
- Low No-load Power Consumption
- No Auxiliary SMPS
- Fast Startup
- X2 Capacitor Discharge Function
- Near Unity Power Factor
- Low Mains Protection
- Overload Protection
- Secondary Short Circuit Protected
- Thermal Protection
- Regulated Output Under any Conditions
- Excellent Load and Line Transient Response
- All Magnetics Available as Standard Parts
- Small Form Factor
- Capability to Implement Off-mode for Extremely Low No-load Power Consumption

Detail Demo-board Schematic Description

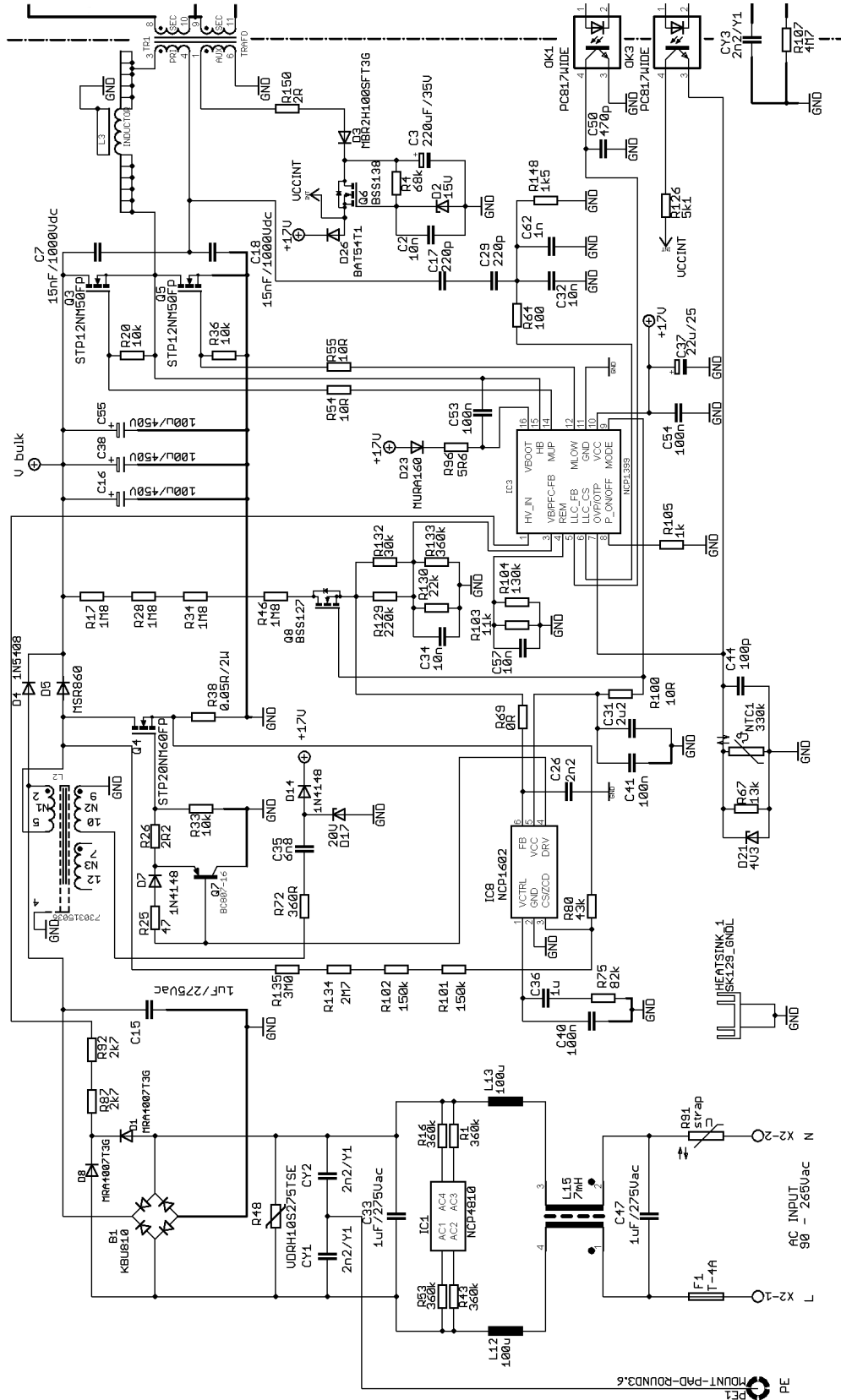
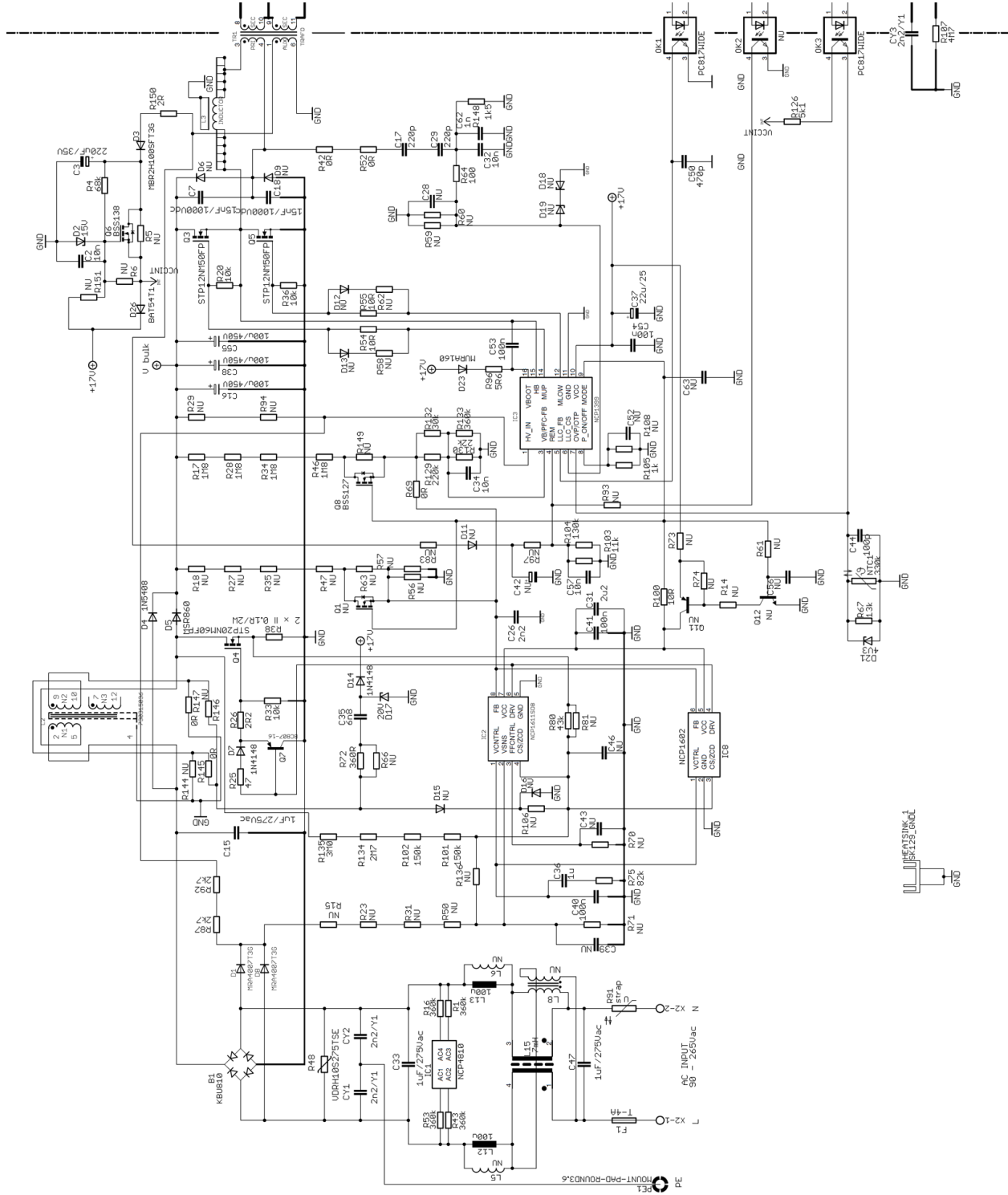

Figure 1. AOI Demo-board Schematic (Assembled Options on Standard Revision of the Demo, Refer to Figures 3 and 4 for Schematic Showing All Possible Options) – Primary Side



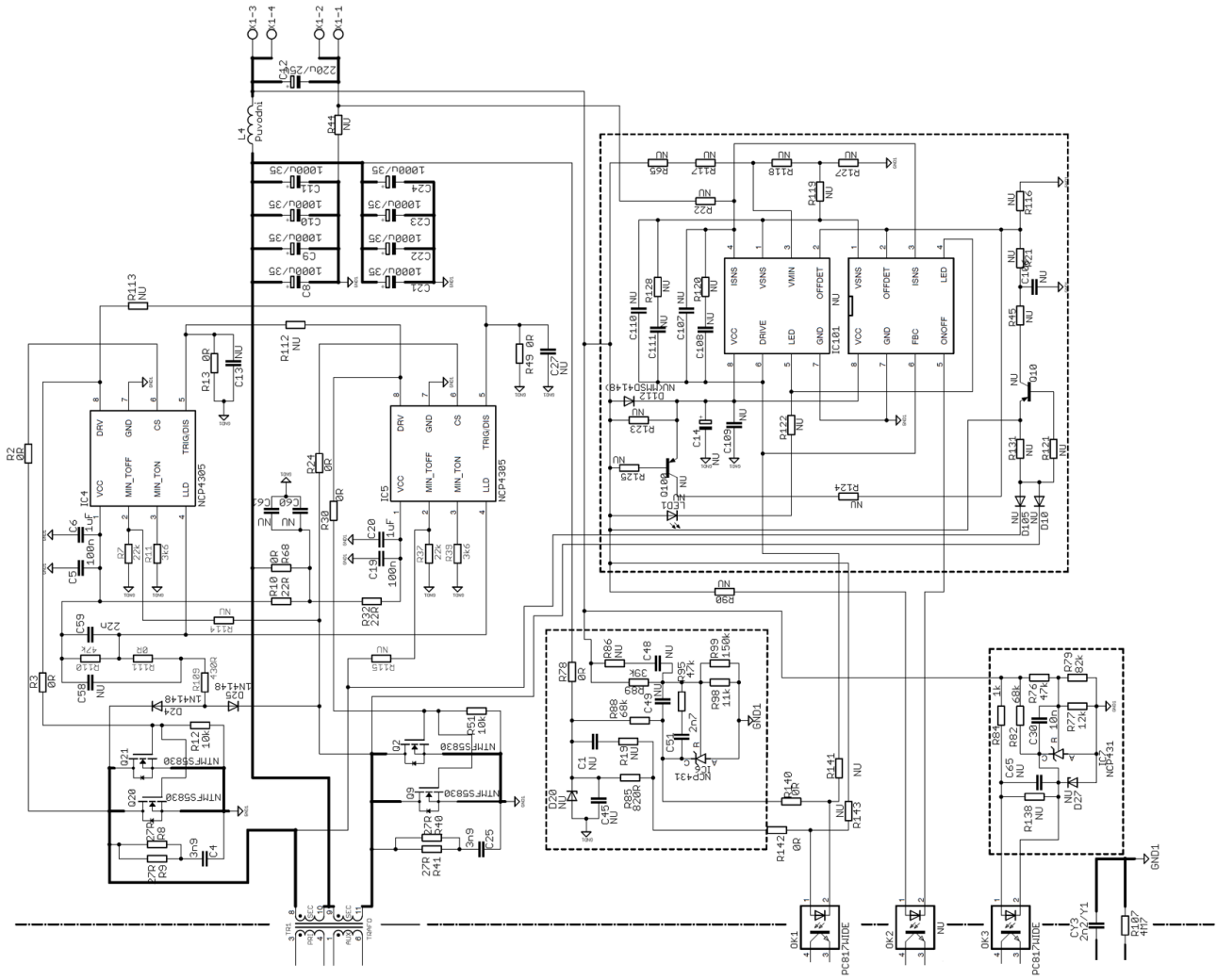

Figure 4. AOI Demo-board Schematic (Assembled and also All Other Possible Options in PCB Layout) – Secondary Side

The input EMI filter is formed by components L₁₅, L₁₂, L₁₃, C₄₇, C₃₃, C_{y1}, C_{y2} and R₄₈ – refer to Figure 1. The inrush current limiting resistor R₉₁ is replaced by strap in this demo revision – one can replace it by appropriate NTC inrush current limiter if needed. The IC₁ (NCP4810) with safety resistors R₅₃, R₁, R₁₆, R₄₃ is used to assure lose-less X2 capacitor discharge function after application is disconnected from the mains.

The PFC power stage uses standard boost PFC topology formed by power components B₁, C₁₅, L₂, D₄, D₅, Q₄, R₃₈, and bulk capacitors C₁₆, C₃₈, C₅₅. The PFC controller IC₈ (NCP1602) senses input voltage indirectly – via PFC power MOSFET drain voltage sensing network R₁₃₅, R₁₃₄, R₁₀₂ and R₁₀₁. The PFC coil current is sensed by the shunt resistor R₃₈. The series resistor R₈₀ defines maximum PFC front stage peak current. The PFC feedback divider is shared with LLC brown-out sensing network in order to reduce application no-load power consumption. The PFC FB/LLC BO divider is formed by resistors R₁₇, R₂₈, R₃₄, R₄₆, R₁₂₉, R₁₃₂, R₁₃₀ and R₁₃₃. The FB signal is filtered by capacitor C₂₆ to overcome possible troubles caused by the parasitic capacitive coupling between pin and other nodes that handle high dV/dt signals. The internal bulk voltage regulator compensation C₄₀, C₃₆ and R₇₅ is connected to the IC₈ pin 1. The PFC MOSFET is driven via circuitry R₂₅, D₇, R₂₆, R₃₃ and Q₇. This solution allows to select needed turn-on and turn-off process speed for Q₄ and also to handle gate discharge current in local loop – minimizing EMI caused by the driver loop. The PFC coil auxiliary winding provides bias for PFC and also LLC controllers during startup phase. Charge pump R₇₂, C₃₅, D₁₄ and D₂₀ is implemented for this purpose.

The LLC power stage primary side composes from these devices: MOSFETs Q₃, Q₅, external resonant coil L₃, transformer TR₁ and resonant capacitors C₇, C₁₈. The IC₃ (NCP1399AA) LLC controller senses primary current indirectly – via resonant capacitor voltage monitoring which is divided down by capacitive divider C₁₇, C₂₉, C₃₂ and C₆₂. The capacitive divider has to provide minimum phase shift between resonant capacitor signal and divided signal on the LLC_CS pin. The capacitive divide has to be loaded in the same time to assure fast LLC_CS pin signal stabilization after application startup – this is achieved by resistor R₁₄₈. The series resistor R₆₄ is used to limit maximum current that can flow into the LLC_CS pin. The FB optocoupler OK₁ is connected to the LLC_FB pin and defines converter output voltage by pulling down this pin when lower output power is needed. Capacitor C₅₀ forms high frequency pole in FB loop characteristics and helps to eliminate eventual noise that could be coupled to the FB pin by parasitic coupling paths. The Brown-out resistor sensing network was already described in PFC section as it is shared with PFC feedback sensing. The Skip/REM pin of the NCP1399 is used for skip threshold adjustment. Resistors R₁₀₃ and R₁₀₄ are used for this purpose together with noise filtering capacitor C₅₇. The over-voltage and over-temperature

protections are implemented via OVP/OTP pin by using resistors R₁₂₆ and R₆₇, temperature dependent resistor NTC₁, zener diode D₂₁, filtering capacitor C₄₄ and optocoupler OK₃. The OVP comparator is located on the secondary side to assure maximum OVP circuitry accuracy. The PFC ON/OFF function is not used in this revision of demo-board – i.e. the bulk voltage is regulated to nominal level during entire board operation (full, medium, light or no-load conditions) thus the P_ON/OFF pin is connected to ground via resistor R₁₀₅. The PFC_MODE pin provides bias to the PFC controller via series resistor R₁₀₀ after high enough voltage is available on the LLC VCC capacitors C₃₇. The VCC decoupling capacitor C₅₄ and also bootstrap capacitor for high side driver powering C₅₃ are located as close to the LLC controller package as possible to minimize parasitic inductive coupling to other IC adjust components due to high driver current peaks that are present in the circuit during drivers rising and falling edges transitions. The bootstrap capacitor is charged via HV bootstrap diode D₂₃ and series resistor R₉₆ which limits charging current and V_{boot} to HB power supply slope during initial C₅₃ charging process. The gate driver currents are reduced by added series resistors R₅₄, R₅₅ to optimize EMI signature of the application.

The primary controllers bias voltage limiter circuitry is used in order to restrict upper value of the primary V_{CC} voltage to approximately 13 V. The VCC limiter composes of these components: resistors R₄, R₁₅₀, capacitors C₂, C₃, diodes D₃, D₂, D₂₆ and transistor Q₆.

The secondary side synchronous rectification uses IC₄ and IC₅ SR controllers – NCP4305. Two MOSFETs are connected in parallel for each SR channel to achieve low total drop – Q₂, Q₉ and Q₂₀, Q₂₁. RC snubber circuits C₄, R₈, R₉ and C₂₅, R₄₀, R₄₁ are used to damp down the parasitic ringing and thus limit the maximum peak voltage on the SR MOSFETs. The SR controllers are supplied from converter output via resistors R₁₀ and R₃₂. These resistors form RC filter with decoupling capacitors C₅, C₆ and C₁₉, C₂₀. The minimum on-time – R₁₁, R₃₉ and minimum off-time – R₇, R₃₇ resistors define needed blanking periods that help to overcome SR controllers false triggering to ringing in the SR power stage. The light load detection circuit (LLD) is formed by resistors R₁₀₉, R₁₁₀ capacitor C₅₉ and diodes D₂₄, D₂₅. The SR controllers are disabled by LLD circuitry when application enters skip mode – this helps to reduce no-load power consumption of application. The trigger/disable function of NCP4305 is not used in this application thus the corresponding pins are grounded. The output filtering capacitor bank composes from low ESR capacitors C₈ to C₁₁ and C₂₁ to C₂₄. Output filter L₄, C₁₂ is used to clean out output voltage from switching glitches.

The output voltage of the converter is regulated by standard shunt regulator NCP431– IC₆. The regulation optocoupler OK₁ is driven via resistor R₈₅ which defines loop gain. The NCP431 is biased via resistor R₈₈ in case there is no current flowing via regulation optocoupler –

which can happen before the nominal V_{OUT} level is reached or during transients from no-load to full-load conditions. The output voltage is adjusted by divider R_{89} and R_{98} , R_{99} . The feedback loop compensation network is formed partially by resistor R_{95} and capacitor C_{51} .

The secondary side OVP sense circuitry is also using NCP431 reference (IC₇) to achieve precise OVP trip point. The OVP threshold is adjusted by resistor divider R_{76} , R_{77} and R_{79} . The bias current of OVP optocoupler OK₃ is limited by resistor R_{84} and IC₇ is biased via resistor R_{82} . Capacitor C_{30} slows down OVP reaction speed and helps overcome false triggering by noise.

There are several options prepared in the PCB layout so that customer can modify demo-board according to his target application needs – please refer to Figure 4 for schematic that shows all options included in the PCB. Mentioned options for instance allow implementation of off-mode control from secondary side to further reduce no-load power consumption or different PFC front stage controller implementation.

Circuit Layout

The PCB consists of a 2 layer FR4 board with 75 μm copper cladding to minimize parasitic resistance in secondary side where high currents are conducted. Leaded components are assembled from the top side of the board and all SMT components are placed from the bottom only so that wave soldering process can be used for production. The board was design to work as open frame with natural air flow cooling. The LLC transformer temperature reaches approximately 90°C for $T_{\text{ambient}} = 25^\circ\text{C}$ and full load. Forced air flow cooling management should be considered in case the board is packed into some box or target application.

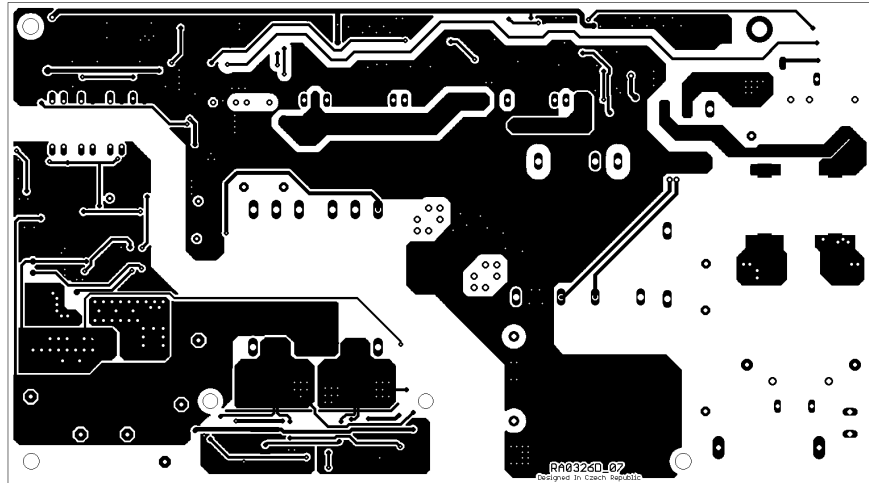

Figure 5. Top Layer

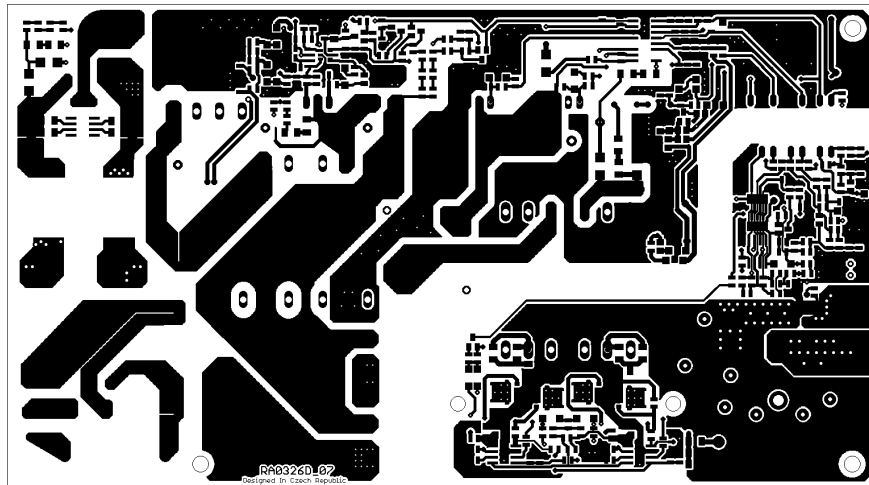

Figure 6. Bottom Layer

EVBUM2342/D

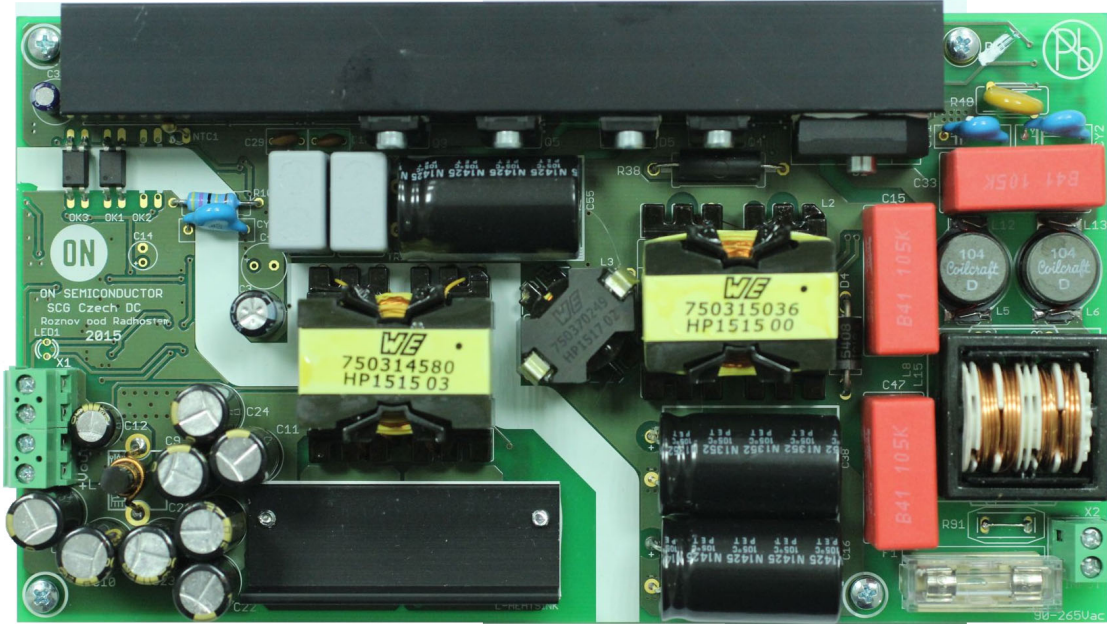

Figure 9. Board Photo – Top Side

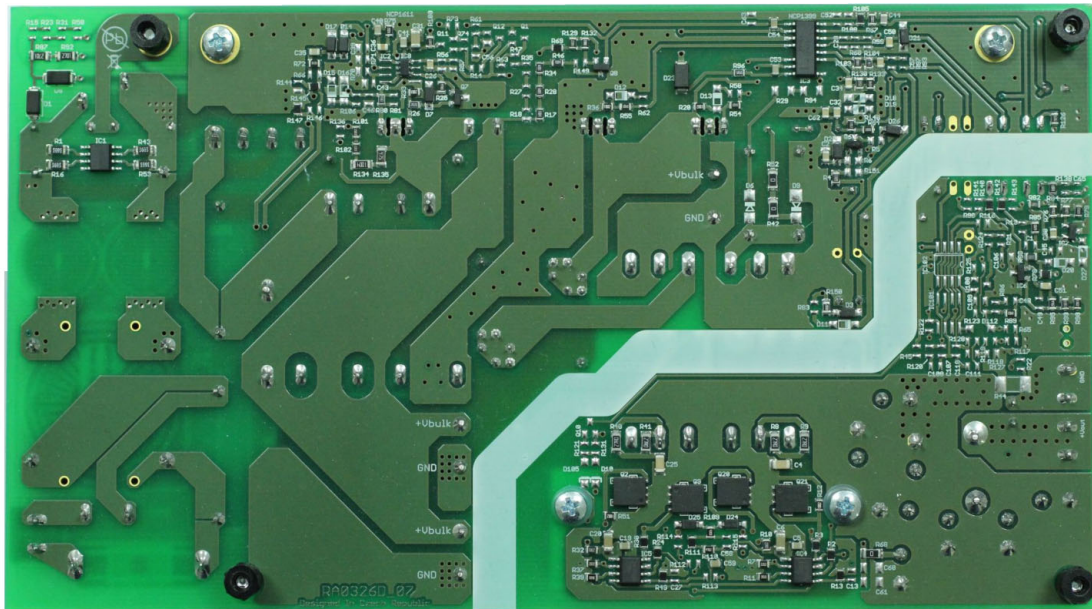

Figure 10. Board Photo – Bottom Side

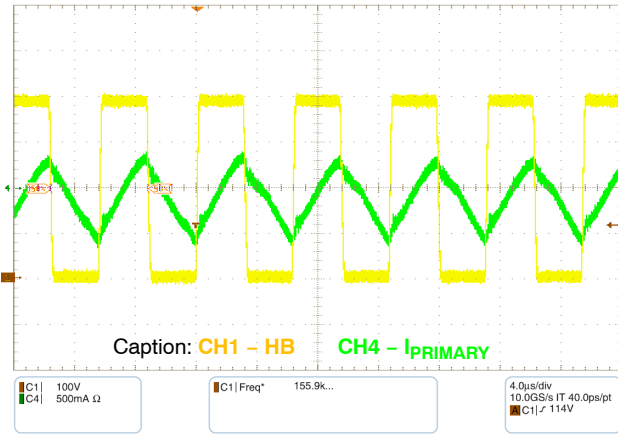

Figure 11. Steady Stage - I_{LOAD} = 1 A

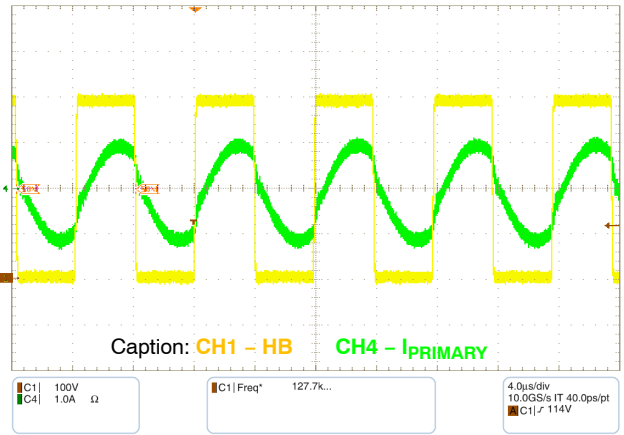

Figure 12. Steady Stage - I_{LOAD} = 10 A

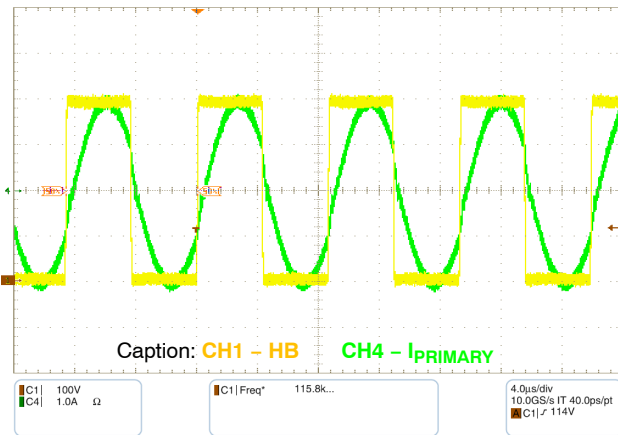

Figure 13. Steady Stage - I_{LOAD} = 20 A

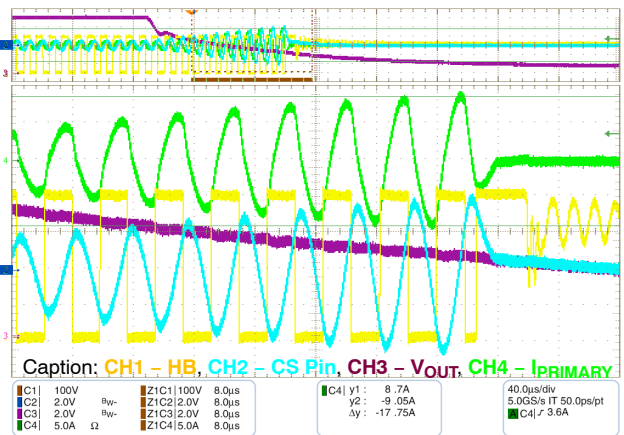

Figure 14. Secondary Short Transition

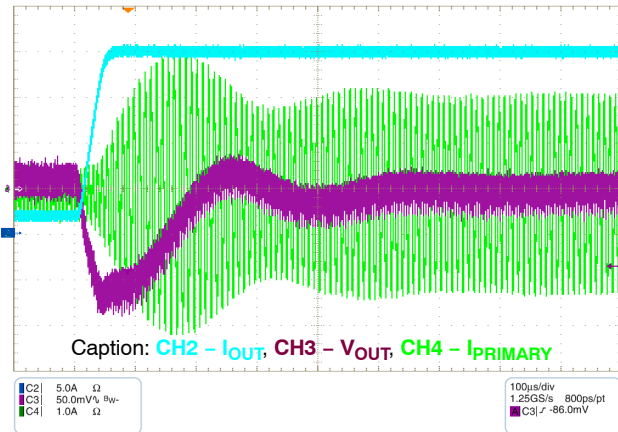

Figure 15. Transition Response - Load Step from 2 to 20 A

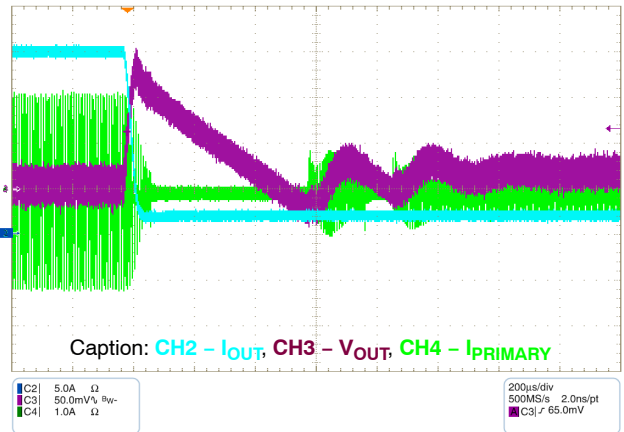

Figure 16. Transition Response - Load Step from 20 to 2 A

EVBUM2342/D

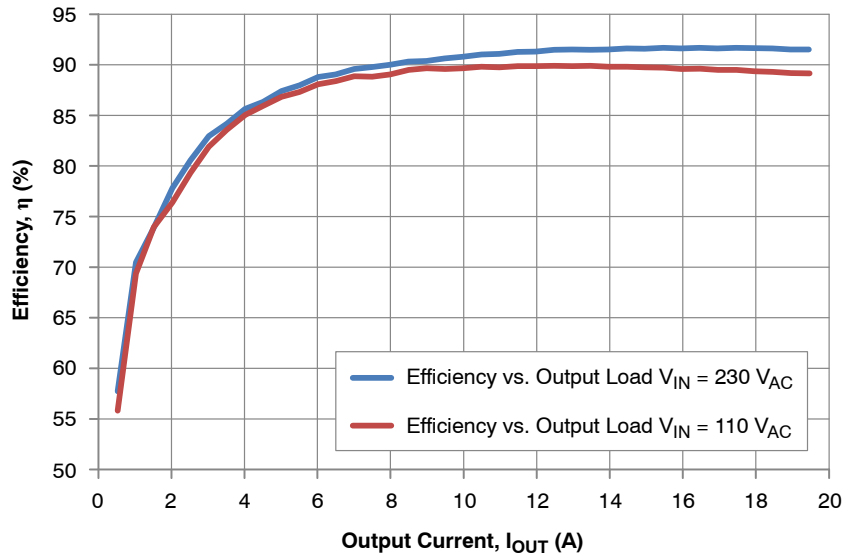

Figure 17. Board Efficiency – Including PFC Stage

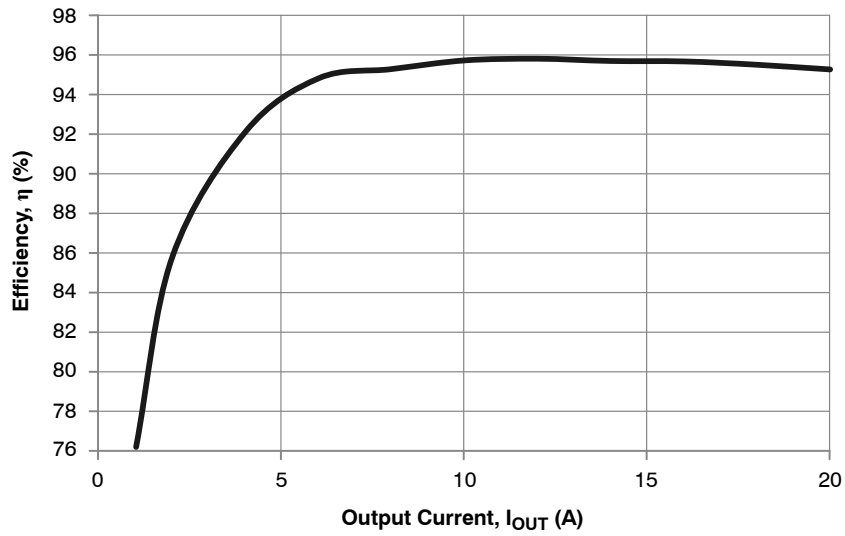

Figure 18. Board Power Stage with SR Efficiency $V_{IN} = 385 V_{DC}$

Table 2. NO-LOAD INPUT POWER CONSUMPTION

Input Voltage	Power Consumption
110 V_{AC}	105 mW
230 V_{AC}	129 mW

EVBUM2342/D

Table 3. BILL OF MATERIALS

Parts	Qty	Description	Value	Tolerance	Footprint	Manufacturer	Manufacturer Part Number	Substitution Allowed
B1	1	Bridge Rectifier	KBU8M	-	KBU8M	Vishay Semiconductor	KBU8M-E4/51	Yes
C1, C13, C27, C28, C39, C43, C45, C46, C48, C49, C52, C56, C58, C63, C65, C106, C107, C108, C109, C110, C111	21	Ceramic Capacitor	NU	-	0805	-	-	Yes
C12	1	Electrolytic Capacitor	220 μ F/25 V	20%	Through Hole	PANASONIC	EEU-FC1E221	Yes
C14	1	Electrolytic Capacitor	NU	-	Through Hole	-	-	Yes
C15, C33, C47	3	MKP Capacitor	1 μ F/275 V _{AC}	10%	Through Hole	Würth Elektronik	MXXP225105K310ASPB 46000	Yes
C16, C38, C55	3	Electrolytic Capacitor	100 μ F/450 V	20%	Through Hole	Rubycon	450BXW100MEFC18X30	Yes
C17, C29	2	Ceramic Capacitor	220 pF/1 kV	20%	Through Hole	Vishay	S221M39SL0N63K7R	Yes
C2, C30, C32, C34, C57	5	Ceramic Capacitor	10 nF	10%	0805	Kemet	C0805C103K5RACTU	Yes
C26	1	Ceramic Capacitor	2.2 nF	10%	0805	Kemet	C0805C222K5RACTU	Yes
C3	1	Electrolytic Capacitor	220 μ F/35 V	20%	Through Hole	PANASONIC	EEU-FM1V221L	Yes
C31	1	Ceramic Capacitor	2.2 μ F	10%	1206	Kemet	C1206C222K5RACTU	Yes
C35	1	Ceramic Capacitor	6.8 nF	10%	0805	Kemet	C0805C682K5RACTU	Yes
C36	1	Ceramic Capacitor	1 μ F	10%	0805	Kemet	C0805C105K5RACTU	Yes
C37	1	Electrolytic Capacitor	22 μ F/35 V	20%	Through Hole	PANASONIC	P15814CT-ND	Yes
C4, C25	2	Ceramic Capacitor	3.9 nF	10%	1206	Kemet	C1206C392K5RACTU	Yes
C42	1	Electrolytic Capacitor	NU	-	Through Hole	-	-	Yes
C44	1	Ceramic Capacitor	100 pF	10%	0805	Kemet	C0805C101K5RACTU	Yes
C5, C19, C40, C41, C53, C54	6	Ceramic Capacitor	100 nF	10%	0805	Kemet	C0805C104K5RACTU	Yes
C50	1	Ceramic Capacitor	470 pF	10%	0805	Kemet	C0805C471K5RACTU	Yes
C51	1	Ceramic Capacitor	2.7 nF	10%	0805	Kemet	C0805C272K5RACTU	Yes
C59	1	Ceramic Capacitor	22 nF	10%	0805	Kemet	C0805C223K5RACTU	Yes
C6, C20,	2	Ceramic Capacitor	1 μ F	10%	1206	Kemet	C1206C105K5RACTU	Yes
C60, C61	2	Ceramic Capacitor	NU	-	1206	-	-	Yes
C62	1	Ceramic Capacitor	1 nF	10%	0805	Kemet	C0805C102K5RACTU	Yes
C7, C18	2	Metal Film Capacitor	15 nF/2 kV _{DC}	5%	Through Hole	Vishay	BFC238560153	No
C8, C9, C10, C11, C21, C22, C23, C24	8	Electrolytic Capacitor	1,000 μ F/16 V	20%	Through Hole	PANASONIC	P15332CT-ND	Yes
CY1, CY2, CY3	3	Ceramic Capacitor	2.2 nF/Y1/X1	20%	Through Hole	Murata	DE1E3KX222MA5BA01	Yes
D1, D8	2	Power rectifier Diode	MRA4007T3G	-	SMA	ON Semiconductor	MRA4007T3G	No
D10, D11, D12, D13, D15, D16, D105, D112	8	Diode	NU	-	SOD-123	-	-	Yes
D17	1	Zener Diode	20 V	5%	SOD-123	ON Semiconductor	MMSZ20T1G	No
D18, D19, D20, D27	3	Zener Diode	NU	-	SOD-123	-	-	Yes
D2	1	Zener Diode	15 V	5%	SOD-123	ON Semiconductor	MMSZ15T1G	No
D21	1	Zener Diode	4.3 V	5%	SOD-123	ON Semiconductor	MMSZ4V7T1G	No
D23	1	Ultrafast Power Rectifier Diode	MURA160	-	SMA	ON Semiconductor	MURA160T3G	No
D26	1	Schottky Diode	BAT54T1	-	SOD-123	ON Semiconductor	BAT54T1G	No
D3	1	Schottky Diode	MBR2H100SFT3G	-	SOD-123	ON Semiconductor	MBR2H100SFT3G	No
D4	1	Standard Recovery Rectifier Diode	1N5408	-	Axial Lead	ON Semiconductor	1N5408RLG	No
D5	1	Soft Recovery Rectifier Diode	MSR860	-	TO-220 (2 LEAD)	ON Semiconductor	MSRF860G	No
D6, D9	2	Diode	NU	-	SMA	-	-	Yes

EVBUM2342/D

Table 3. BILL OF MATERIALS (continued)

Parts	Qty	Description	Value	Tolerance	Footprint	Manufacturer	Manufacturer Part Number	Substitution Allowed
D7, D14, D24, D25	4	Switching Diode	MMSD4148	-	SOD-123	ON Semiconductor	MMSD4148T3G	No
F1 - FUSE	1	Fuse, Medium Delay	T-4A	-	-	Bussmann	TDC 210-4A	Yes
F1 - Holder	1	Fuse Holder	-	-	SH22.5A	Multicomp	MCHTC-15M	Yes
F1 - Cover	1	Cover, PCB Fuse Holder	-	-	-	Multicomp	MCHTC-150M	Yes
HEATSINK_1	1	Heat Sink	SK 454 150 SA	-	SK 454 150 SA	Fischer Elektronik	SK 454 150 SA	Yes
HEATSINK_1	1	Heat Sink	-	-	-	-	-	Yes
IC1	1	X2 Capacitor Discharger	NCP4810	-	SOIC-8	ON Semiconductor	NCP4810DR2G	No
IC101	1	Secondary Side Sleep mode Controller	NU	-	SOIC-8	-	-	No
IC102	1	Secondary Side Sleep mode Controller	NU	-	SOIC-8	-	-	No
IC2	1	Power Factor Controller	NU	-	SOIC-8	-	-	No
IC3	1	Resonant Mode Controller	NCP1399	-	SOIC-16	ON Semiconductor	NCP1399AADR2G	No
IC4, IC5	2	Secondary Side Synchronous Rectifier	NCP4305	-	SOIC-8	ON Semiconductor	NCP4305DDR2G	No
IC6, IC7	2	Programmable Precision Reference	NCP431	-	SOT-23	ON Semiconductor	NCP431AVSNT1G	No
IC8	1	Power Factor Controller	NCP1602	-	TSOP-6	ON Semiconductor	NCP1602DCCSNT1G	No
L2	1	PFC Inductor	260 μ H	10%	PQ3225	Würth Elektronik	750315036	Yes
L12, L13	2	Inductor	100 μ H	20%	DO5040H	Coilcraft	DO5040H-104MLB	Yes
L15	1	Emi Filter	2.9 mH	15%	TLBI	ICE Components	LF-28030-0029-H	Yes
L3	1	Resonant Inductor	52 μ H	10%	RM8	Würth Elektronik	750370249	Yes
L4	1	Inductor	200 nH	20%	L-US20A	Bohemia Electric	TC-05001510-00	Yes
L5, L6	2	Inductor	NU	-	-	-	-	Yes
L8	1	Inductor	NU	-	-	-	-	Yes
LED1	1	LED 3 mm	NU	-	Through Hole	-	-	Yes
NTC1	1	Thermistor	330 k Ω	-	Through Hole	Vishay	NTCLE100E3334JB0	Yes
OK1, OK3	2	Opto Coupler	817B	-	DIP-4	Fairchild	FOD817B	Yes
OK2	1	Opto Coupler	NU	-	DIP-4	-	-	Yes
Q1	1	N-Channel MOSFET	NU	-	SOT-23	-	-	Yes
Q10, Q100	2	PNP Transistor	NU	-	SOT-23	-	-	Yes
Q11	1	PNP Transistor	NU	-	SOT-23	-	-	Yes
Q12	1	NPN Transistor	NU	-	SOT-23	-	-	Yes
Q2, Q9, Q20, Q21	4	N-Channel MOSFET	NVMF5830NL	-	SO-8FL/DFN-5	ON Semiconductor	NVMF5830NLT1G	No
Q3, Q5	2	N-Channel MOSFET	STP12NM50FP	-	TO-220	ST Microelectronics	STP12NM50FP	Yes
Q4	1	N-Channel MOSFET	STP20NM60FP	-	TO-220	ST Microelectronics	STP20NM60FP	Yes
Q6	1	N-Channel MOSFET	BSS138	-	SOT-23	ON Semiconductor	BSS138LT1G	No
Q7	1	PNP Transistor	BC807	-	SOT-23	ON Semiconductor	BC807-16LT1G	No
Q8	1	N-Channel MOSFET	BSS127	-	SOT-23	Diodes Incorporated	BSS127S-7	No
R1, R16, R43, R53,	4	Resistor SMD	360 k Ω	1%	1206	Rohm Semiconductor	MCR18ERTJ364	Yes
R10, R32	2	Resistor SMD	22 Ω	1%	0805	Rohm Semiconductor	MCR10EZPF22R0	Yes
R104	1	Resistor SMD	130 k Ω	1%	0805	Rohm Semiconductor	MCR10EZPF1303	Yes
R107	1	Resistor through Hole, High Voltage	4.7 M Ω	5%	0414	Vishay	VR37000004704JA100	Yes
R109	1	Resistor SMD	430 Ω	1%	0805	Rohm Semiconductor	MCR10EZPF4300	Yes

EVBUM2342/D

Table 3. BILL OF MATERIALS (continued)

Parts	Qty	Description	Value	Tolerance	Footprint	Manufacturer	Manufacturer Part Number	Substitution Allowed
R11, R39	2	Resistor SMD	3.6 kΩ	1%	0805	Rohm Semiconductor	MCR10EZPF3601	Yes
R12, R20, R33, R36, R51	5	Resistor SMD	10 kΩ	1%	0805	Rohm Semiconductor	MCR10EZPF1002	Yes
R126	1	Resistor SMD	5.1 kΩ	1%	0805	Rohm Semiconductor	MCR10EZPF5101	Yes
R129	1	Resistor SMD	220 kΩ	1%	0805	Rohm Semiconductor	MCR10EZPF2203	Yes
R132	1	Resistor SMD	30 kΩ	1%	0805	Rohm Semiconductor	MCR10EZPF3002	Yes
R133	1	Resistor SMD	360 kΩ	1%	0805	Rohm Semiconductor	MCR10EZPF3603	Yes
R134	1	Resistor SMD	2.7 MΩ	5%	1206	Rohm Semiconductor	MCR18ERTJ275	Yes
R135	1	Resistor SMD	3 MΩ	5%	1206	Rohm Semiconductor	MCR18ERTJ305	Yes
R148	1	Resistor SMD	1.5 kΩ	1%	0805	Rohm Semiconductor	MCR10EZPF1501	Yes
R150	1	Resistor SMD	2 Ω	5%	0805	Rohm Semiconductor	MCR10EZHJ2R0	Yes
R17, R28, R34, R46	4	Resistor SMD	1.8 MΩ	5%	0805	Rohm Semiconductor	MCR25JZHJ185	Yes
R2, R3, R13, R24, R30, R49, R69, R78, R111, R140, R142, R145, R147	13	Resistor SMD	0 Ω	-	0805	Rohm Semiconductor	MCR10EZPJ000	Yes
R25	1	Resistor SMD	47 Ω	1%	0805	Rohm Semiconductor	MCR10EZPF47R0	Yes
R26	1	Resistor SMD	2.2 Ω	5%	0805	Rohm Semiconductor	MCR10EZHJ2R2	Yes
R29, R94	2	Resistor SMD	NU	-	1206	-	-	Yes
R38	1	Power Resistor	0.0 Ω/3 W	1%	Through Hole	Vishay/Dale	LVR03R0500FR50	Yes
R4, R82, R88	3	Resistor SMD	68 kΩ	1%	0805	Rohm Semiconductor	MCR10EZPF6802	Yes
R42, R52, R68	3	Resistor SMD	0 Ω	-	1206	Rohm Semiconductor	MCR18EZHJ000	Yes
R44	1	Resistor SMD	NU	-	2010	-	-	Yes
R48	1	VARISTOR	275 V _{AC}	1%	Through Hole	Würth Elektronik	820512711	Yes
R5, R6, R14, R15, R18, R19, R21, R22, R23, R27, R31, R35, R45, R47, R50, R56, R57, R58, R59, R60, R61, R62, R63, R65, R66, R70, R71, R73, R74, R81, R83, R86, R90, R93, R97, R106, R108, R112, R113, R114, R115, R116, R117, R118, R119, R120, R121, R122, R123, R124, R125, R127, R128, R131, R136, R138, R141, R143, R144, R146, R149, R151	62	Resistor SMD	NU	-	0805	-	-	Yes
R54, R55, R100	3	Resistor SMD	10 Ω	1%	0805	Rohm Semiconductor	MCR10EZPF10R0	Yes
R64	1	Resistor SMD	100 Ω	1%	0805	Rohm Semiconductor	MCR10EZPF1000	Yes

EVBUM2342/D

Table 3. BILL OF MATERIALS (continued)

Parts	Qty	Description	Value	Tolerance	Footprint	Manufacturer	Manufacturer Part Number	Substitution Allowed
R67	1	Resistor SMD	13 kΩ	1%	0805	Rohm Semiconductor	MCR10EZPF1302	Yes
R7, R37, R130	3	Resistor SMD	22 kΩ	1%	0805	Rohm Semiconductor	MCR10EZPF2202	Yes
R72	1	Resistor SMD	360 Ω	1%	0805	Rohm Semiconductor	MCR10EZPF3600	Yes
R75, R79	2	Resistor SMD	82 kΩ	1%	0805	Rohm Semiconductor	MCR10EZPF8202	Yes
R76, R95, R110	3	Resistor SMD	47 kΩ	1%	0805	Rohm Semiconductor	MCR10EZPF4702	Yes
R77	1	Resistor SMD	12 kΩ	1%	0805	Rohm Semiconductor	MCR10EZPF1202	Yes
R8, R9, R40, R41	4	Resistor SMD	27 Ω	1%	1206	Rohm Semiconductor	MCR18ERTJ270	Yes
R80	1	Resistor SMD	43 kΩ	1%	0805	Rohm Semiconductor	MCR10EZPF4302	Yes
R84, R105	2	Resistor SMD	1 kΩ	1%	0805	Rohm Semiconductor	MCR10EZPF1001	Yes
R85	1	Resistor SMD	820 Ω	1%	0805	Rohm Semiconductor	MCR10EZPF8200	Yes
R87, R92	2	Resistor SMD	2.7 kΩ	1%	1206	Rohm Semiconductor	MCR18ERTF2701	Yes
R89	1	Resistor SMD	39 kΩ	1%	0805	Rohm Semiconductor	MCR10EZPF3902	Yes
R91	1	NTC Thermistor	0 Ω	1%	strap	-	-	Yes
R96	1	Resistor SMD	5.6 Ω	5%	0805	Rohm Semiconductor	MCR10EZHJ5R6	Yes
R98, R103	2	Resistor SMD	11 kΩ	1%	0805	Rohm Semiconductor	MCR10EZPF1102	Yes
R99, R101, R102	3	Resistor SMD	150 kΩ	1%	0805	Rohm Semiconductor	MCR10EZPF1503	Yes
TR1	1	Transformer	750314580	10%	PQ3225	Würth Elektronik	750314580	Yes
X1	1	Output Terminal Block	Pitch 5 mm	-	20.700M/2	IMO	20.700M/2	Yes
X2	1	Input Terminal Block	Pitch 5 mm	-	KRE 02	LUMBERG	KRE 02	Yes

NOTE: All parts are Pb-Free.

ON Semiconductor and the ON Semiconductor logo are trademarks of Semiconductor Components Industries, LLC dba ON Semiconductor or its subsidiaries in the United States and/or other countries. ON Semiconductor owns the rights to a number of patents, trademarks, copyrights, trade secrets, and other intellectual property. A listing of ON Semiconductor's product/patent coverage may be accessed at www.onsemi.com/site/pdf/Patent-Marking.pdf. ON Semiconductor is an Equal Opportunity/Affirmative Action Employer. This literature is subject to all applicable copyright laws and is not for resale in any manner.

The evaluation board/kit (research and development board/kit) (hereinafter the "board") is not a finished product and is as such not available for sale to consumers. The board is only intended for research, development, demonstration and evaluation purposes and should as such only be used in laboratory/development areas by persons with an engineering/technical training and familiar with the risks associated with handling electrical/mechanical components, systems and subsystems. This person assumes full responsibility/liability for proper and safe handling. Any other use, resale or redistribution for any other purpose is strictly prohibited.

The board is delivered "AS IS" and without warranty of any kind including, but not limited to, that the board is production-worthy, that the functions contained in the board will meet your requirements, or that the operation of the board will be uninterrupted or error free. ON Semiconductor expressly disclaims all warranties, express, implied or otherwise, including without limitation, warranties of fitness for a particular purpose and non-infringement of intellectual property rights.

ON Semiconductor reserves the right to make changes without further notice to any board.

You are responsible for determining whether the board will be suitable for your intended use or application or will achieve your intended results. Prior to using or distributing any systems that have been evaluated, designed or tested using the board, you agree to test and validate your design to confirm the functionality for your application. Any technical, applications or design information or advice, quality characterization, reliability data or other services provided by ON Semiconductor shall not constitute any representation or warranty by ON Semiconductor, and no additional obligations or liabilities shall arise from ON Semiconductor having provided such information or services.

The boards are not designed, intended, or authorized for use in life support systems, or any FDA Class 3 medical devices or medical devices with a similar or equivalent classification in a foreign jurisdiction, or any devices intended for implantation in the human body. Should you purchase or use the board for any such unintended or unauthorized application, you shall indemnify and hold ON Semiconductor and its officers, employees, subsidiaries, affiliates, and distributors harmless against all claims, costs, damages, and expenses, and reasonable attorney fees arising out of, directly or indirectly, any claim of personal injury or death associated with such unintended or unauthorized use, even if such claim alleges that ON Semiconductor was negligent regarding the design or manufacture of the board.

This evaluation board/kit does not fall within the scope of the European Union directives regarding electromagnetic compatibility, restricted substances (RoHS), recycling (WEEE), FCC, CE or UL, and may not meet the technical requirements of these or other related directives.

FCC WARNING – This evaluation board/kit is intended for use for engineering development, demonstration, or evaluation purposes only and is not considered by ON Semiconductor to be a finished end product fit for general consumer use. It may generate, use, or radiate radio frequency energy and has not been tested for compliance with the limits of computing devices pursuant to part 15 of FCC rules, which are designed to provide reasonable protection against radio frequency interference. Operation of this equipment may cause interference with radio communications, in which case the user shall be responsible, at its expense, to take whatever measures may be required to correct this interference.

ON Semiconductor does not convey any license under its patent rights nor the rights of others.

LIMITATIONS OF LIABILITY: ON Semiconductor shall not be liable for any special, consequential, incidental, indirect or punitive damages, including, but not limited to the costs of requalification, delay, loss of profits or goodwill, arising out of or in connection with the board, even if ON Semiconductor is advised of the possibility of such damages. In no event shall ON Semiconductor's aggregate liability from any obligation arising out of or in connection with the board, under any theory of liability, exceed the purchase price paid for the board, if any.

For more information and documentation, please visit www.onsemi.com.

PUBLICATION ORDERING INFORMATION

LITERATURE FULFILLMENT:

Email Requests to: orderlit@onsemi.com

ON Semiconductor Website: www.onsemi.com

TECHNICAL SUPPORT

North American Technical Support:

Voice Mail: 1 800-282-9855 Toll Free USA/Canada

Phone: 011 421 33 790 2910

Europe, Middle East and Africa Technical Support:

Phone: 00421 33 790 2910

For additional information, please contact your local Sales Representative