

Strip Block for Snap-in Mounting with 4 IEC Appliance Outlets F and Space for 1 fused inlet

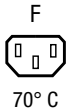

Order required accessories separately

Snap-in version



See below:

Approvals and Compliances

Description

- Panel mount :
 Snap-in version from front side
- 1 Function :
 Module of 4 outlets , with additional carrier frame for accessory mo-
 dules , Pin temperature 70 °C , Protection class I
- Solder terminals or quick connect terminals

Characteristics

- Busbar is of single piece (no soldering)
- Insulation cover on the rear-side
- Suitable for use in equipment according to IEC/UL 60950

Other versions on request

- For protection class II

References

We recommend for new applications [0909](#)
 Last order date: 15.12.2018

Weblinks

[pdf data sheet](#), [html datasheet](#), [General Product Information](#), [Distributor-Stock-Check](#), [Accessories](#), [Detailed request for product](#)

Technical Data

Ratings IEC	10A / 250VAC; 50Hz	appliance inlet/-outlet	F acc. to IEC 60320-3
Ratings UL/CSA	15A / 250VAC; 60Hz		UL 60320-1 CSA C22.2 no. 60320-1
Dielectric Strength	> 2 kVAC between L-N > 2 kVAC between L/N-PE (1 min/50Hz)		(for cold conditions) pin-temperature 70 °C, 10A, Protection Class I
Allowable Operation Temperature	-25 °C to 70 °C		
IP-Protection	from front side IP30 acc. to IEC 60529		
Insulation cover	Suitable for appliances with protection class I acc. to IEC 61140		
Terminal	Solder terminals or quick connect terminals		
Panel Thickness S	Snap-in1/1.2/1.5/2/2.5/3 mm tolerance +/-0.1		
Material: Housing	Thermoplastic, black, UL 94V-0		

Approvals and Compliances

Detailed information on product approvals, code requirements, usage instructions and detailed test conditions can be looked up in [Details about Approvals](#)

SCHURTER products are designed for use in industrial environments. They have approvals from independent testing bodies according to national and international standards. Products with specific characteristics and requirements such as required in the automotive sector according to IATF 16949, medical technology according to ISO 13485 or in the aerospace industry can be offered exclusively with customer-specific, individual agreements by SCHURTER.

Approvals



The approval mark is used by the testing authorities to certify compliance with the safety requirements placed on electronic products.

Approval Reference Type: 4758

Approval Logo	Certificates	Certification Body	Description
	VDE Approvals	VDE	Certificate Number: 40030337
	UL Approvals	UL	UL File Number: E103791

Product standards

Product standards that are referenced

Organization	Design	Standard	Description
	Designed according to	IEC 60320-1	Appliance couplers for household and similar general purposes
	Designed according to	IEC 60320-3	Appliance couplers for household and similar general purposes
	Designed according to	UL 60320-1	Standard for Attachment Plugs and Receptacles
	Designed according to	CSA C22.2 no. 60320-1	General Use Receptacles, Attachment Plugs, and Similar Wiring Devices





Application standards

Application standards where the product can be used

Organization	Design	Standard	Description
	Designed for applications acc.	IEC/UL 60950	IEC 60950-1 includes the basic requirements for the safety of information technology equipment.

Compliances

The product complies with following Guide Lines

Identification	Details	Initiator	Description
	CE declaration of conformity	SCHURTER AG	The CE marking declares that the product complies with the applicable requirements laid down in the harmonisation of Community legislation on its affixing in accordance with EU Regulation 765/2008.
	RoHS	SCHURTER AG	Directive RoHS 2011/65/EU, Amendment (EU) 2015/836
	China RoHS	SCHURTER AG	The law SJ / T 11363-2006 (China RoHS) has been in force since 1 March 2007. It is similar to the EU directive RoHS.
	REACH	SCHURTER AG	On 1 June 2007, Regulation (EC) No 1907/2006 on the Registration, Evaluation, Authorization and Restriction of Chemicals 1 (abbreviated as "REACH") entered into force.

Dimensions [mm]

Quadblock and Cut-out for a 2 mm snap-in inlet with fuseholder type 6200 or 6220

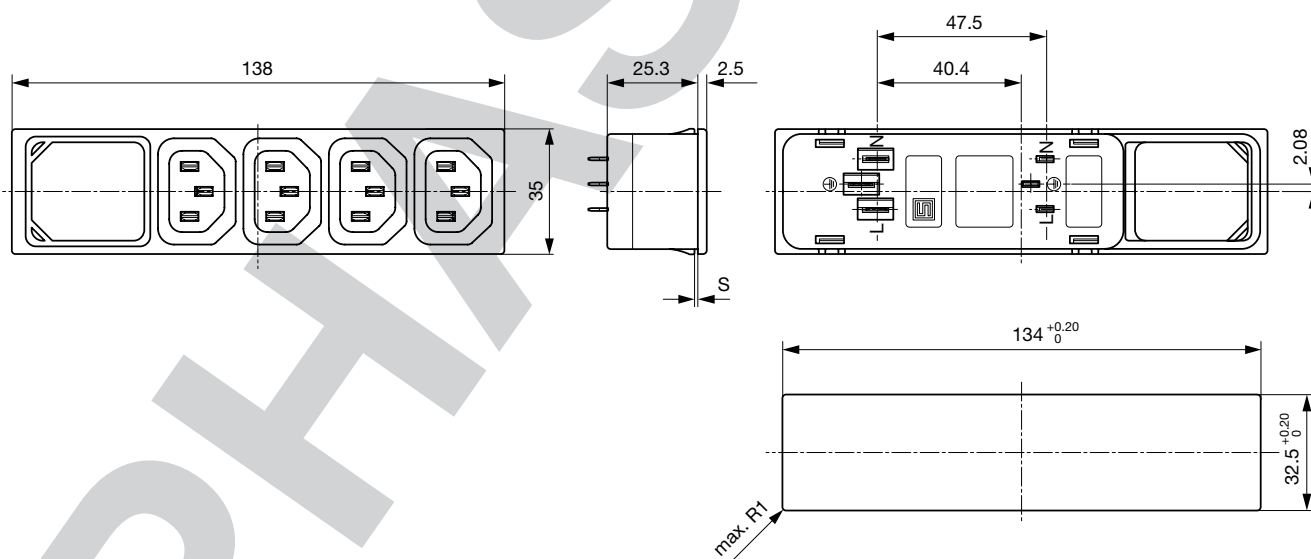

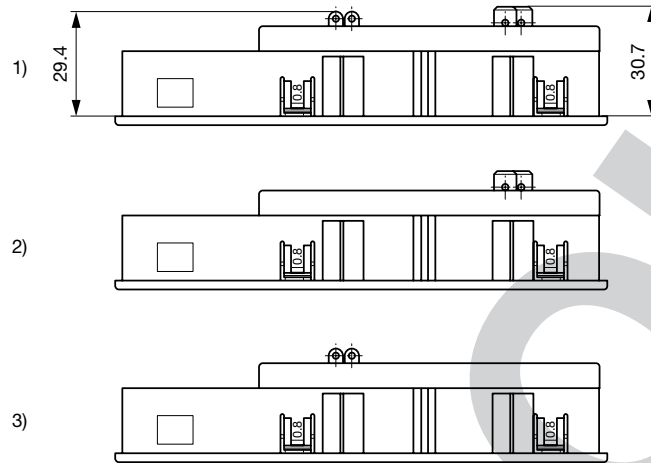

- 1) Solder and quick connect terminals 6.3x0.8 mm
- 2) only quick connect terminals 6.3x0.8 mm
- 3) only solder terminals

All Variants

Panel Thickness [mm]	Terminal	Length [mm]	Order Number
1	Quick connect terminals 6.3 x 0.8 mm	138 mm	4758.3200
1.2	Quick connect terminals 6.3 x 0.8 mm	138 mm	4758.8200
1.5	Quick connect terminals 6.3 x 0.8 mm	138 mm	4758.4200
2	Quick connect terminals 6.3 x 0.8 mm	138 mm	4758.5200
2.5	Quick connect terminals 6.3 x 0.8 mm	138 mm	4758.6200
3	Quick connect terminals 6.3 x 0.8 mm	138 mm	4758.7200
1	Solder terminals 4 x 0.8 mm	138 mm	4758.3400
1.2	Solder terminals 4 x 0.8 mm	138 mm	4758.8400
1.5	Solder terminals 4 x 0.8 mm	138 mm	4758.4400
2	Solder terminals 4 x 0.8 mm	138 mm	4758.5400
2.5	Solder terminals 4 x 0.8 mm	138 mm	4758.6400
3	Solder terminals 4 x 0.8 mm	138 mm	4758.7400
1	Solder terminals 4 x 0.8 mm and quick connect terminals 6.3 x 0.8 mm	138 mm	4758.3000
1.2	Solder terminals 4 x 0.8 mm and quick connect terminals 6.3 x 0.8 mm	138 mm	4758.8000
1.5	Solder terminals 4 x 0.8 mm and quick connect terminals 6.3 x 0.8 mm	138 mm	4758.4000
2	Solder terminals 4 x 0.8 mm and quick connect terminals 6.3 x 0.8 mm	138 mm	4758.5000
2.5	Solder terminals 4 x 0.8 mm and quick connect terminals 6.3 x 0.8 mm	138 mm	4758.6000
3	Solder terminals 4 x 0.8 mm and quick connect terminals 6.3 x 0.8 mm	138 mm	4758.7000

Availability for all products can be searched real-time: <https://www.schurter.com/en/Stock-Check/Stock-Check-SCHURTER>

Please note, all quadblocs are available in protection-class II upon request.

Cord retaining clamp see accessories

Packaging unit 50 Pcs

Mating Inlets/Plugs

Category / Description

[Plug Overview complete](#)



4732, Mounting: Power Cord, Plug: IEC E, Cable	4732
4735, Mounting: Power Cord, Plug: IEC E, Cable	4735
9009, Mounting: Plug: IEC E, Screw clamps	9009
4733, Mounting: Power Cord, Plug: IEC E, Cable	4733
4736, Mounting: Power Cord, Plug: IEC E, Cable	4736

[Plug further types to 4758](#)

PHASE-OUT