



Universal QUAD Mode LED Driver

The DRW-A4D series of compact LED drivers offers universal input voltages (120/230/277V), patent pending, quad mode dimming and superior performance for compact lighting fixtures, such as downlights, tracklights/spotlights and wall sconces where small form factor, flexibility in dimming control and input voltage requirements are critical factors.

Product Offering

- Power:** 15 / 21 / 30 W
- Universal Input:** 120 / 220-240 / 277 V (50/60 Hz)
- Output:** 350 / 500 / 700 mA (30-42 V)
- Quad Mode Dimming:** Leading and Trailing edge Phase Cut, 0/1 – 10V, PWM
- Plastic and Metal (Back Feed) housing options**
- UL Listed, Class P (Class 2 Output)**
- Suitable for dry or damp locations**

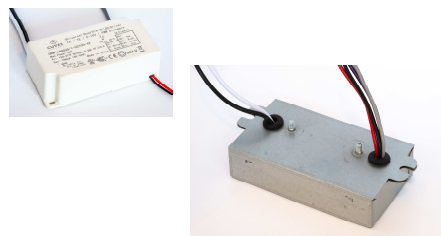

Features and Benefits

Universal Input	One fixture design that works across all major countries' AC voltages (120 / 220-240 / 277V), simplifying design and SKU reduction
Quad Mode Dimming	One fixture design that works across all major dimming methods, phase cut (LE/TE), 0/1-10V and PWM, simplifying design and SKU reduction
Compact Size	Specifically designed to fit in small lighting fixtures
Deep Dimming	Excellent dimming performance to less than 1% with stable light output
5 Year Warranty	Backed by the industry leading warranty of 5 years gives confidence in long term reliability and maintenance free operation



Universal Input



Quad-Mode Dimming

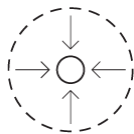

COMPACT SIZE



DEEP DIMMING



5 YEAR WARRANTY





1 - Input Characteristics

Specification item	Value	Condition
Nominal Input Voltage Range AC	120 – 277 VAC	
Nominal Input Voltage Range AC	108 – 305 VAC	Operational range
Maximum Input Current @120V	0.14 A (15W) 0.21 A (21W) 0.28 A (30W)	Full output power @ 120V Input Voltage
Maximum Input Current @230V	0.08 A (15W) 0.11 A (21W) 0.15 A (30W)	Full output power @ 230V Input Voltage
Maximum Input Current @277V	0.07 A (15W) 0.09 A (21W) 0.13 A (30W)	Full output power @ 277V Input Voltage
Input Frequency	50 / 60 Hz	Performance range
Power Factor with Full Load	> 0.9	Full output power @ 120 / 230 / 277V Input Voltage
Efficiency @ 120V	87% (15W) 86% (21W) 85% (30W)	Full load @ 120V Input Voltage
Efficiency @ 230 / 277V	87% (15W) 88% (21W) 89% (30W)	Full load @ 230V / 277V Input Voltage
THD with Full Load	< 20% (15W) < 20% (21W) < 20% (30W)	At nominal input voltage and nominal LED voltage
Maximum Inrush Current	< 10 A	At 120 – 277V input 25°C cold start at 100% conditions. For more details in the attached graph
No-load Power Consumption	< 0.5 W	
Start-up Time	< 0.5 s	





2 - Output Characteristics

Specification item	Value	Condition
Rated LED Output Power	11 – 15W (15W) 15 – 21W (21W) 21 – 30W (30W)	
Nominal LED Output Current	350 mA (15W) 500 mA (21W) 700 mA (30W)	
LED Output Current Tolerance	±5%	
LED Output Voltage Range DC	30 – 42 VDC	
Open Loop (no load) Voltage	< 52 VDC	driver will limit the output voltage to <52V if LED load is opened
Output Current Ripple LF	< 10%	< 2KHz
Output P _{st} LM	< 0.5	
Output SVM	< 0.4	

3 - Dimming Characteristics

Specification item	Value	Condition
Dimming Protocol	1. Leading Edge Phase-Cut 2. Trailing Edge Phase-Cut 3. 0/1 – 10V 4. PWM	All 4 dimming protocols supported at all input voltages of 120V / 220 – 240V / 277V
Dimming Range	1% - 100% typical	Actual dimming performance is dimmer dependent. Please consult Cuvee for specific dimmer compatibility



3.1 - 0/1 – 10V Dimming Control Characteristics

Specification item	Value	Condition
Dim+, Dim-	0/1 – 10V	The DRW-A4D series operate with 0/1 – 10V dimmers. The Dim+/Dim- signal pins can be used to adjust the output via a standard commercial wall dimmer, an external control voltage source (0 to 10 Vdc), or a variable resistor
Current Supplied by Dim+ Signal Pin	< 1mA	
Output Current Tolerance While Being Dimmed	±8%	

0/1 – 10V Dimming

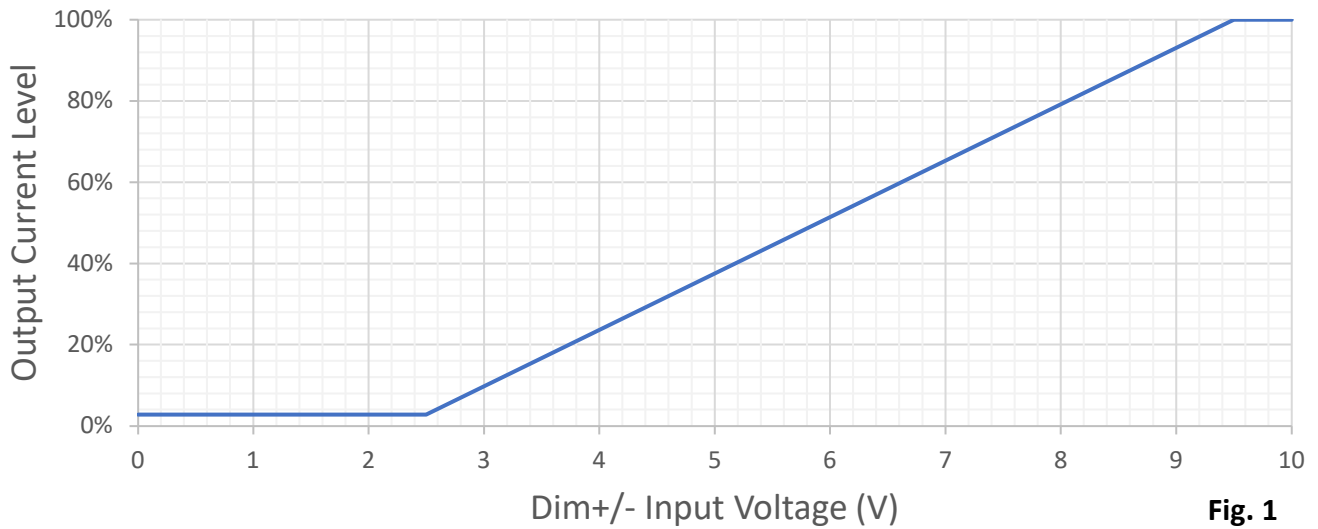

Fig. 1

A fixed or variable resistor can be also used from the Dim+ signal pin to the Dim- pin to adjust the output current

Resistance Dimming

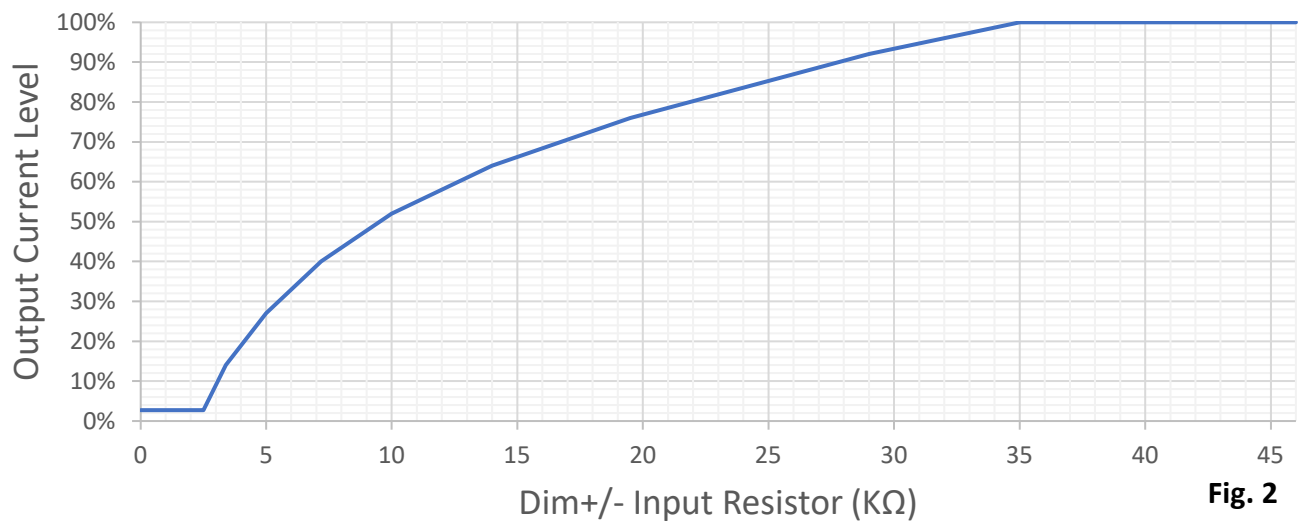

Fig. 2



3.2 - PWM Dimming Control Characteristics

Specification item	Value	Condition
Dim+, Dim-	10 – 12V (Pk-Pk)	The Dim+/Dim- signal pins can be used to adjust the output via a standard PWM dimmer
Input Pulse Minimum Pulse Width	2 μ s	
PWM Frequency	15Hz – 150KHz	

PWM Dimming

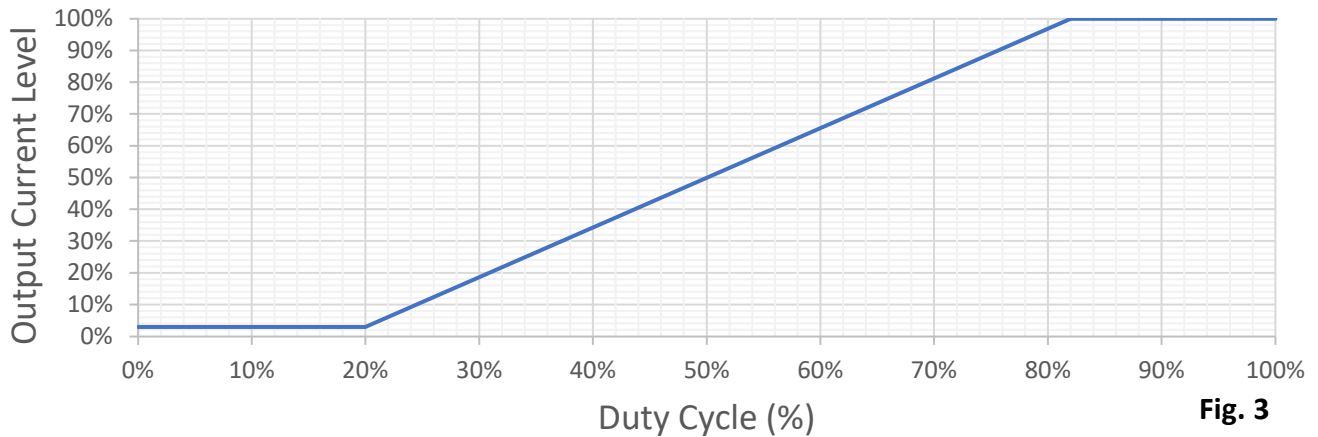

Fig. 3

4 - Environmental Conditions

Specification item	Value	Condition
Ambient Temperature (Ta) Range	-20 to 45°C	Higher ambient temperature are possible as long as Tc conforms to the operating case temperature range
Operating Case Temperature (Tc) Range	-20 to 72°C	Case Temperature measured at Tc mark on product
Max. Case Temperature (Tc max)	95°C	Case Temperature measured at Tc mark on product
Storage Temperature	-40 to 85°C	
Relative Humidity	80%	Non-condensing
Lifetime	50,000 hours	At Tc within Operating Case Temperature Range. See details in Section 11.
Warranty	5 years	At Tc within Operating Case Temperature Range.
Working Locations	Suitable for dry or damp locations	

5 - Protection Features

Specification item	Value	Condition
Over Current Protection (OCP)	YES	Automatic recovery
Over Temperature Protection (OTP)	YES	Gradually reduce output power when Tc exceed 85°C. Automatic recovery
Output Short-Circuit Protection (SCP)	YES	Automatic recovery

6 - Outline Drawing

6.1a - Outline Drawing (Plastic)

L x W x H
81.4 x 41.3 x 25.5 mm

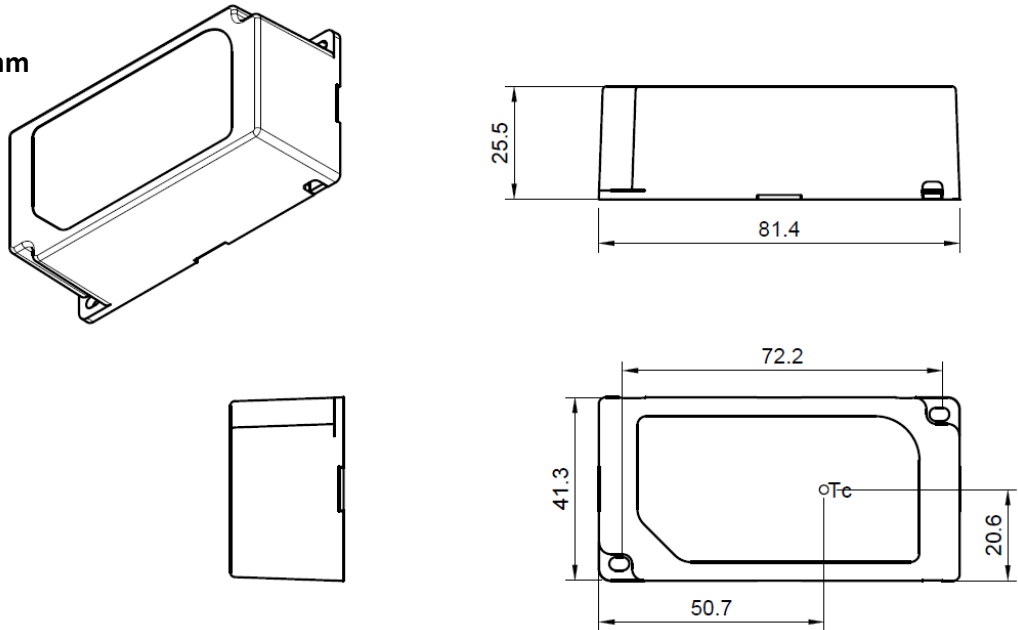

6.1b - Mechanical Details

Specification item	Value	Condition
Length (L)	81.4 mm	
Width (W)	41.3 mm	
Height (H)	25.5 mm	
Weight	125 g	

6.1c - Wire Specifications

Input Wire (L-Black / N-White)	18 AWG
Output Wire (LED+ - Red / LED- - Black)	22 AWG
Dim+ (Purple) / Dim- (Grey) Control Wire	22 AWG
Wire Length (Input / Output / Control)	10 - 15 cm



6.2a - Outline Drawing (Metal Back Feed)

L x W x H
107.3 x 60.04 x 25.26 mm

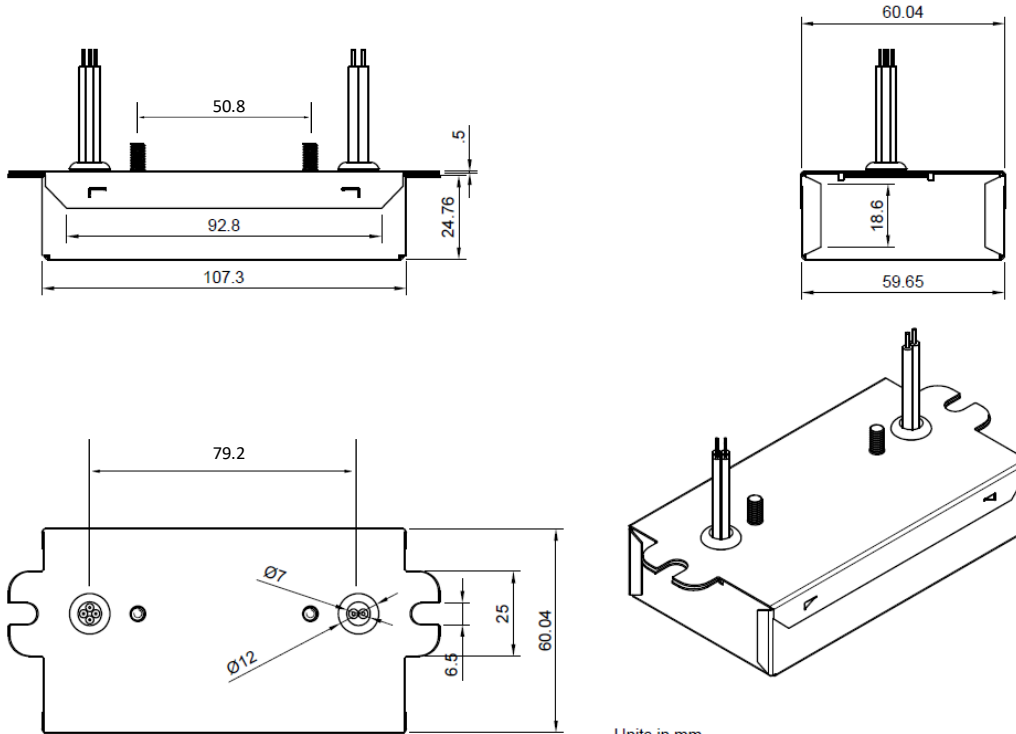

6.2b - Mechanical Details

Specification item	Value	Condition
Length (L)	107.3 mm	
Width (W)	60.04 mm	
Height (H)	25.26 mm	
Weight	250 g	

6.2c - Wire Specifications

Input Wire (L-Black / N-White)	18 AWG
Output Wire (LED+ - Red / LED- - Black)	22 AWG
Dim+ (Purple) / Dim- (Grey) Control Wire	22 AWG
Wire Length (Input / Output / Control)	10 - 15 cm





7 - EMC Compliance Approvals

Specification item	Value	Condition
Conducted and Radiated EMI	FCC CFR Title 47 Part 15 Class B EN 55015:2013 (CISPR 15:2013)	at 120 Vac and 277 Vac at 220, 230, and 240 Vac
Harmonic Current Emissions	IEC 61000-3-2:2014	For Class C equipment
Voltage Fluctuations & Flicker	IEC 61000-3-3:2013	
ESD (Electrostatic Discharge)	IEC 61547 Section 5.2 Test des.: IEC 61000-4-2	4 kV contact discharge, 8 kV air discharge, level 3
Continuous Radiated Disturbance	IEC 61547 Section 5.3 Test des.: IEC 61000-4-3	3 V/m, 80 - 1000 MHz, 80% modulated at distance of 3 meters
Electrical Fast Transient	IEC 61547 Section 5.5 Test des.: IEC 61000-4-4	± 1 kV on AC power port for 1 minute, ±1 kV on signal/control lines
Surge	IEC 61547 Section 5.7 Test des.: IEC 61000-4-5	± 1 kV line to line (differential mode)
Continuous Conducted Disturbance	IEC 61547 Section 5.6 Test des.: IEC 61000-4-6	3V, 0.15-80 MHz, 80% modulated, Level 2
Power Frequency Magnetic Field	IEC 61547 Section 5.4 Test des.: IEC 61000-4-8	3A/m, 50/60Hz, level 2
Voltage Dips	IEC 61547 Section 5.8, 5.9 Test des.: IEC 61000-4-11	70% dip during 25 cycles @ 50Hz, 30 cycles @ 60Hz 0% dip during ½ cycles

8 - Safety Agency Approvals

Specification item	Value	Condition
UL / cUL	UL 8750	UL Listed, Class P (Class 2 Output) (E514800)
ENEC / CE / UKCA	EN 61347-1:2015, EN 61347-2-13:2014/A1:2017	



9 – Graphs (120V)

Operating Window

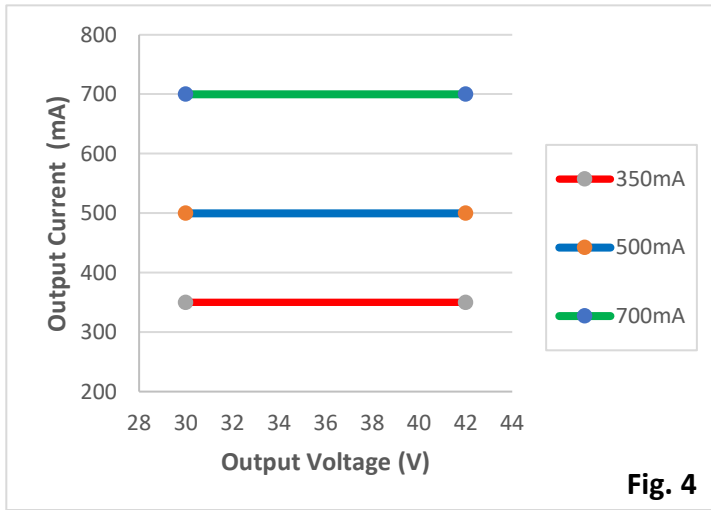

Power Factor vs. Load

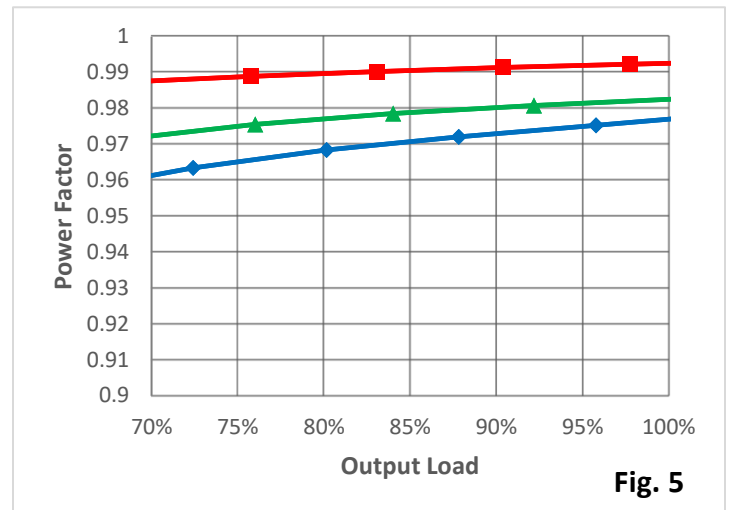

Efficiency vs. Load

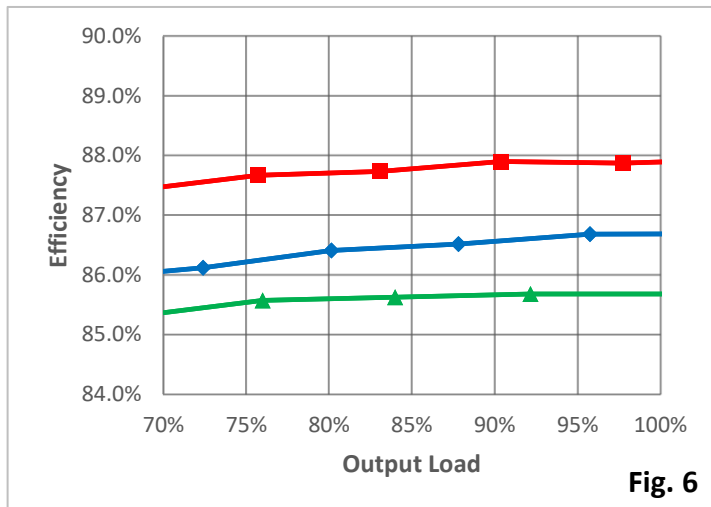

Input Current vs. Load

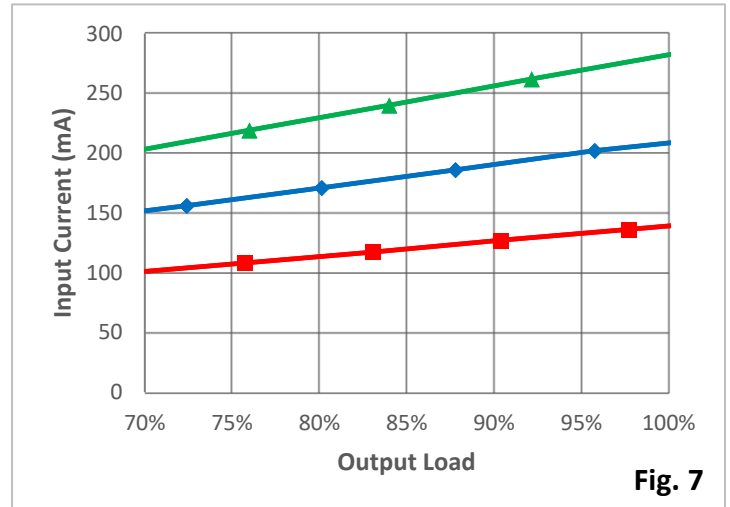

9 – Graphs (230V)

Operating Window

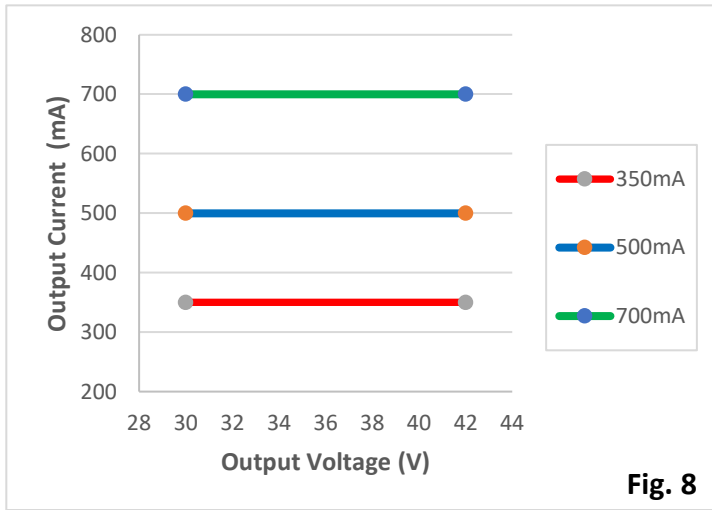

Power Factor vs. Load

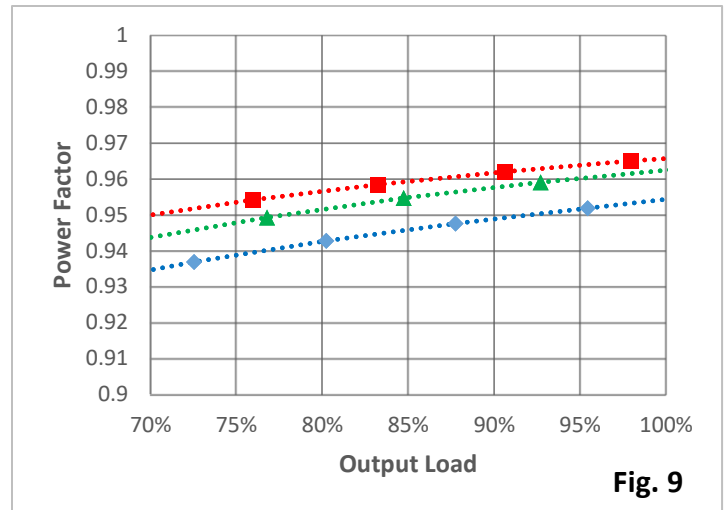

Efficiency vs. Load

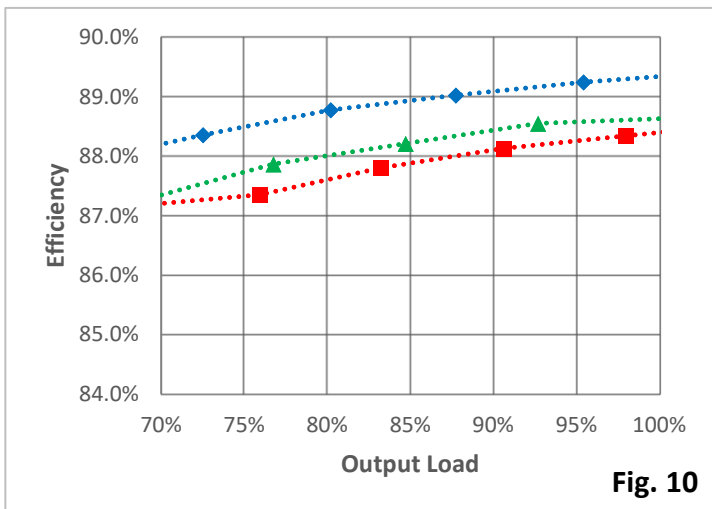

Input Current vs. Load

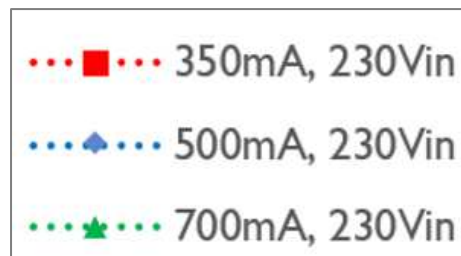
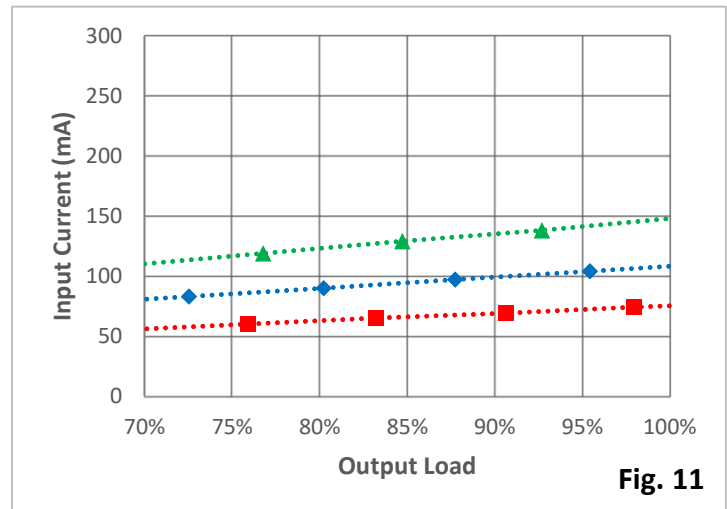

9 – Graphs (277V)

Operating Window

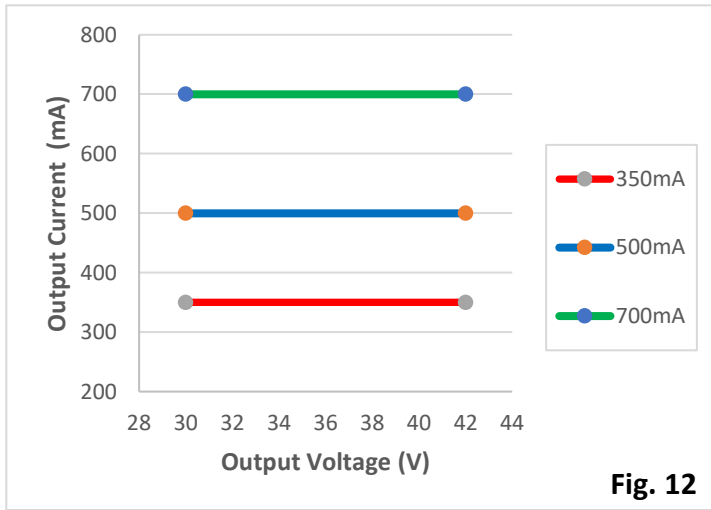

Power Factor vs. Load

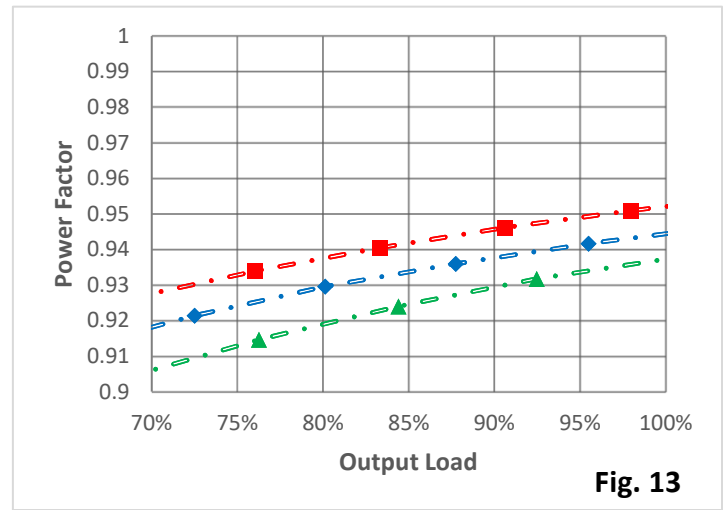

Efficiency vs. Load

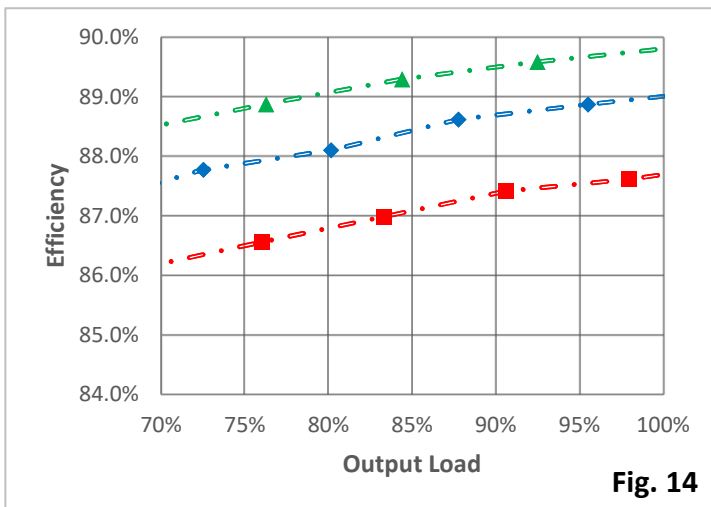

Input Current vs. Load

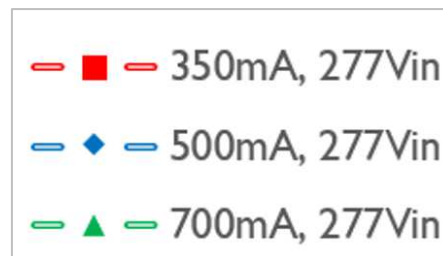
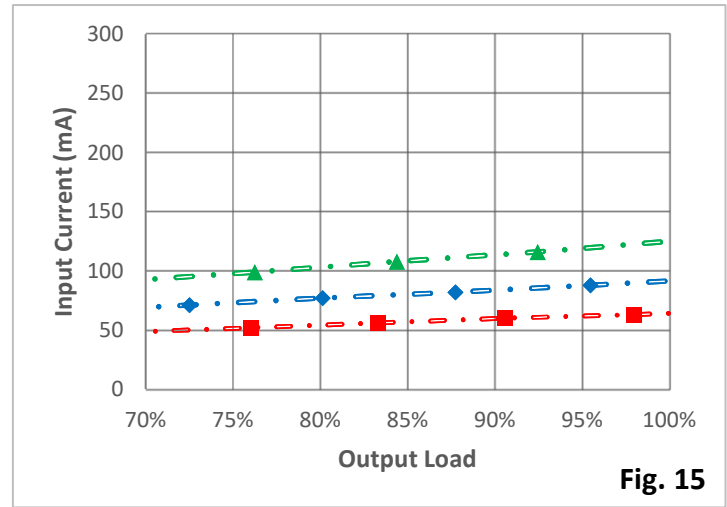

10 - Inrush Current

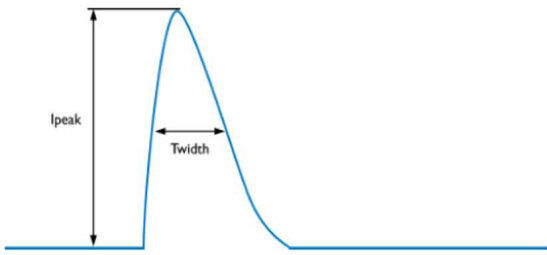

Input Voltage	I _{peak} (A)			T _{width} (Time @50% of I _{peak})
	15 W	21 W	30 W	
120Vac	1.69 A	2.53 A	4.56 A	110 μs
230Vac	3.10 A	4.65 A	8.37 A	177 μs
277Vac	3.70 A	5.56 A	10.00 A	204 μs

Estimated Maximum Number of Drivers per Miniature Circuit Breaker (MCB)*

Estimated Maximum Number of Drivers per MCB (15W)

Input Voltage	B10	B13	B16	B20	C10	C13	C16	C20
120Vac	42	55	68	85	50	65	80	100
230Vac	75	97	120	150	87	113	140	175
277Vac	85	111	137	171	100	130	160	200

Estimated Maximum Number of Drivers per MCB (21W)

Input Voltage	B10	B13	B16	B20	C10	C13	C16	C20
120Vac	28	37	45	57	33	43	53	66
230Vac	54	70	87	109	63	82	101	127
277Vac	66	86	106	133	77	101	124	155

Estimated Maximum Number of Drivers per MCB (30W)

Input Voltage	B10	B13	B16	B20	C10	C13	C16	C20
120Vac	21	28	34	43	25	33	40	50
230Vac	40	52	64	80	47	61	75	93
277Vac	41	54	66	83	54	70	86	108

* Estimation based on typical MCB characteristics; recommend users to calculate the actual number with MCB parameters intended to be used



11 - Predicted Lifetime verse Case and Ambient Temperature

Predicted Lifetime (Hours) vs Temperature
DRW-A4D015/1-CC350-42-350(BF)

Fig. 19

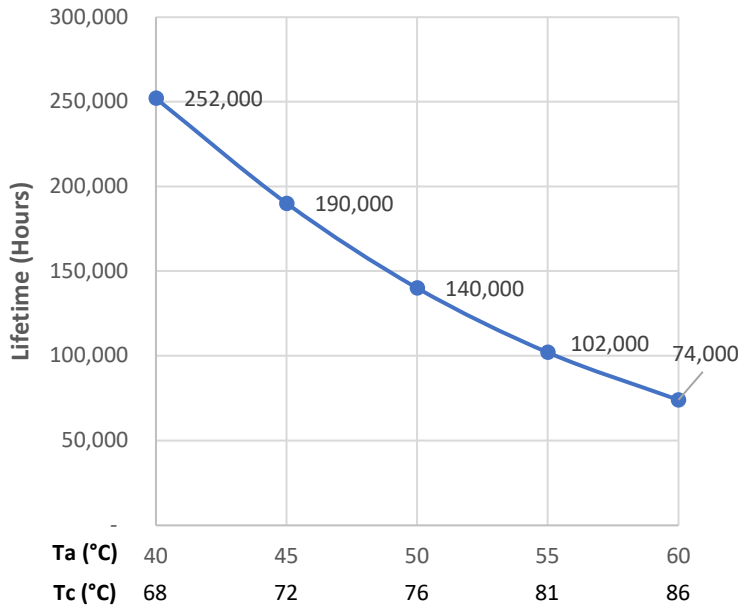

Predicted Lifetime (Hours) vs Temperature
DRW-A4D021/1-CC500-42-500(BF)

Fig. 20

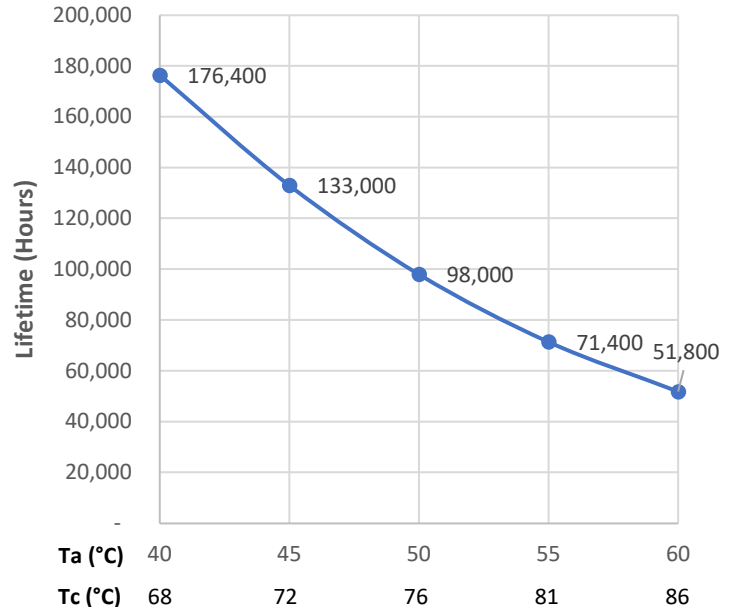

Predicted Lifetime (Hours) vs Temperature
DRW-A4D030/1-CC700-42-700(BF)

Fig. 21

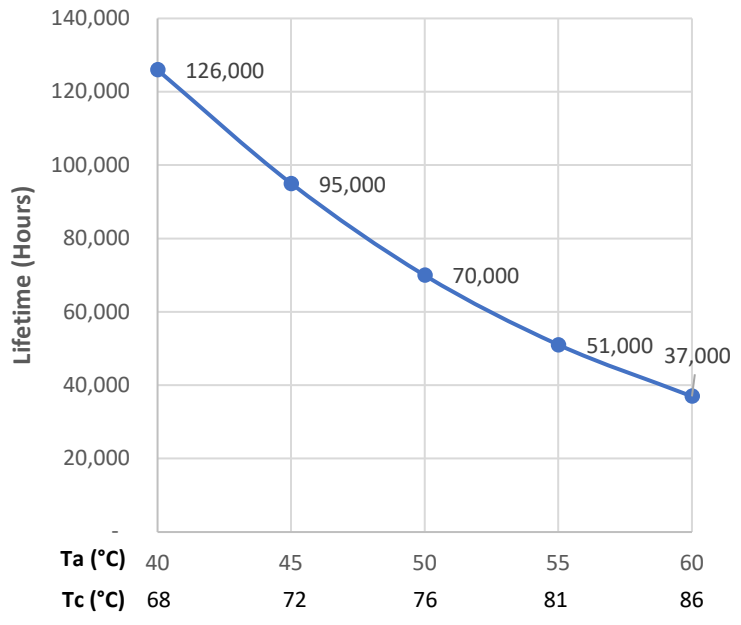

12 - Ordering Info

Specification item	Part Number	Housing
15W Driver (350mA / 30 – 42V)	DRW-A4D015/1-CC350-42-350	Plastic (White)
21W Driver (500mA / 30 – 42V)	DRW-A4D021/1-CC500-42-500	Plastic (White)
30W Driver (700mA / 30 – 42V)	DRW-A4D030/1-CC700-42-700	Plastic (White)
15W Driver (350mA / 30 – 42V)	DRW-A4D015/1-CC350-42-350BF	Metal (Back Feed)
21W Driver (500mA / 30 – 42V)	DRW-A4D021/1-CC500-42-500BF	Metal (Back Feed)
30W Driver (700mA / 30 – 42V)	DRW-A4D030/1-CC700-42-700BF	Metal (Back Feed)

