

4-line ESD protection for high speed lines

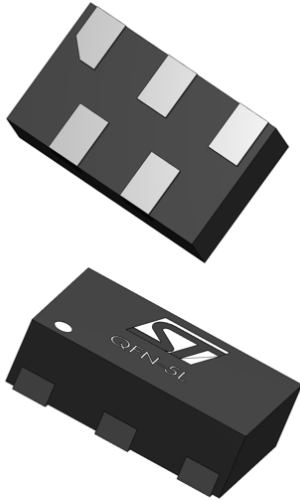

μQFN-5L

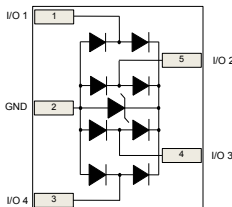

Features

- Very compact 500 μm pitch package, for easy PCB layout
- Very-large bandwidth: 11.5 GHz (HSP051-4M5), 18 GHz (HSP053-4M5)
- Very-low capacitance: 0.35 pF (HSP051-4M5 - I/O to GND), 0.25 pF (HSP053-4M5 - I/O to GND)
- Low leakage current: < 1 nA
- High integration
- Suitable for high density boards
- Extended operating junction temperature range : -40 °C to 150 °C
- Exceeds IEC 61400-4-2 level standard:
 - ±20 kV (HSP051-4M5, contact discharge)
 - ±10 kV (HSP053-4M5, contact discharge)
 - ±30 kV (HSP051-4M5, air discharge)
 - ±25 kV (HSP053-4M5, air discharge)

Applications

The **HSP051-4M5** and **HSP053-4M5** are designed to protect against to electro-static discharge sub-micron technology circuits driving:

- HDMI 2.1, HDMI 2.0 and HDMI 1.4
- USB4, USB 3.2 Gen 2 and Gen 1
- Display port
- Digital video interface
- Serial ATA

The ultra low variation of the capacitance ensures very low influence on signal-skew. The large bandwidth make it compatible with HDMI 2.1 8K (12 Gbps), HDMI 2.0 4K/2K (5.94 Gbps), USB4 (20 Gbps) and USB 3.1 Gen 2 (10 Gbps)

Description

The **HSP051-4M5** and **HSP053-4M5** are a 4-channel ESD array with a rail to rail architecture designed specifically for the protection of high speed differential lines.

The device is packaged in μQFN 1.3 mm x 0.8 mm with a 500 μm pitch.

Product status link

[HSP051-4M5,](#)
[HSP053-4M5](#)

1 Characteristics

Table 1. Absolute maximum ratings ($T_{amb} = 25\text{ }^{\circ}\text{C}$)

Symbol	Parameter		Value	Unit	
V_{PP}	Peak pulse voltage	IEC 61000-4-2: Contact discharge	HSP051-4M5	20	kV
			HSP053-4M5	10	
		IEC 61000-4-2: Air discharge	HSP051-4M5	30	
			HSP053-4M5	25	
I_{PP}	Peak pulse current (8/20 μs)		HSP051-4M5	3	A
T_{stg}	Storage temperature range			-65 to +150	$^{\circ}\text{C}$
T_j	Operating junction temperature range			-40 to +150	
T_L	Maximum lead temperature for soldering during 10 s			260	

Figure 1. Electrical characteristics - parameters definition

Symbol	Parameter
V_{BR}	= Breakdown voltage
V_{CL}	= Clamping voltage
I_{RM}	= Leakage current at V_{RM}
V_{RM}	= Stand-off voltage
I_F	= Forward current
I_R	= Breakdown current
I_{PP}	= Peak pulse current
V_F	= Forward voltage drop
R_d	= Dynamic resistance

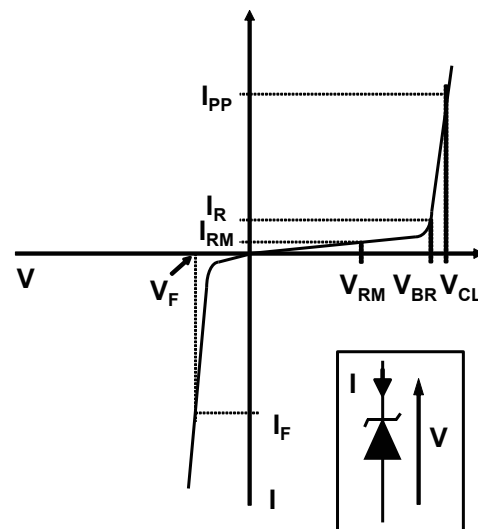

Table 2. Electrical characteristics (T_{amb} = 25 °C)

Symbol	Parameter		Test conditions	Min.	Typ.	Max.	Unit			
V _{BR}	Breakdown voltage		I _R = 1 mA	HSP051-4M5	5.7	6.4	V			
				HSP053-4M5	5.3	5.8				
V _{RM}	Reverse working voltage					5				
I _{RM}	Leakage current		V _{RM} = 3.6 V per line		< 1	50	nA			
			V _{RM} = 5 V per line			3		70		
V _{CL}	Reverse Clamping voltage		I _{pp} = 3A, 8/20μs	HSP051-4M5		11.3	V			
			TLP measurement (pulse duration 100 ns), 16 A I _{pp}		HSP051-4M5	13.7				
					HSP053-4M5	19.5				
			8 kV contact discharge after 30 ns, IEC 61000-4-2		HSP051-4M5	13				
			HSP053-4M5	16						
R _d	Dynamic resistance, TLP measurement (pulse duration 100 ns)		I/O to GND		HSP051-4M5	0.35	Ω			
					HSP053-4M5	0.68				
			GND to I/O		HSP051-4M5	0.45				
					HSP053-4M5	0.65				
C _{I/O - I/O}	Capacitance V _{I/O} = 0 V, V _{OSC} = 30 mV		F = 2.5 GHz to 9 GHz		HSP051-4M5	0.20	0.30	pF		
					HSP053-4M5	0.15	0.20			
C _{I/O - GND}					F = 200 MHz to 2.5 GHz		HSP051-4M5		0.60	0.76
							HSP053-4M5		0.35	0.5
	F = 2.5 GHz to 9 GHz				HSP051-4M5	0.35	0.43			
					HSP053-4M5	0.25	0.4			
f _C	Differential mode cut-off frequency at - 3dB				HSP051-4M5	11.5	GHz			
					HSP053-4M5	18				

1.1 Characteristics (curves)

Figure 2. Leakage current versus junction temperature (typical values)

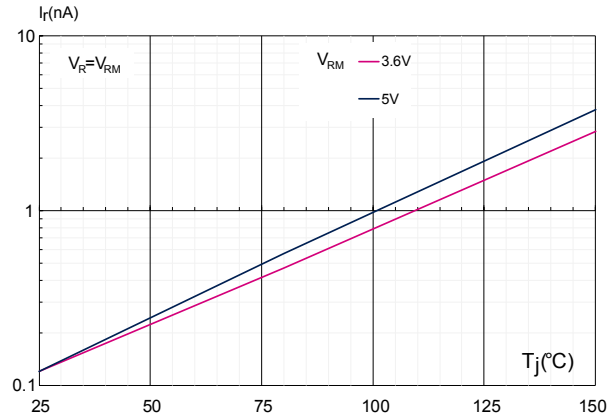

Figure 3. HSP051-4M5 S21 attenuation measurement

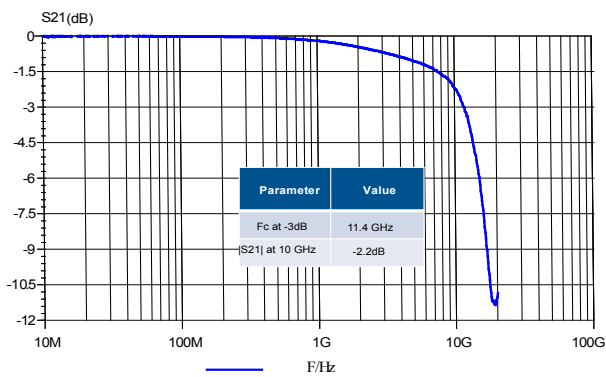

Figure 4. HSP053-4M5 S21 attenuation measurement

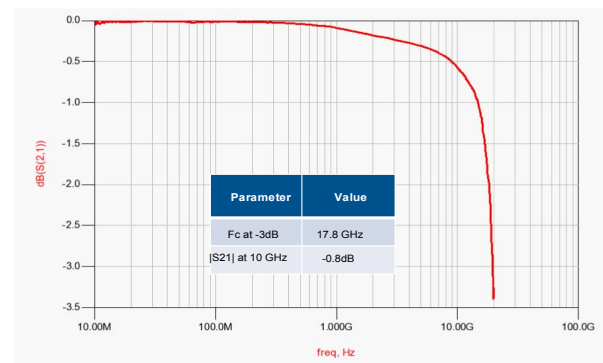

Figure 5. HDMI2.1 12 Gbps eye diagram without HSP0x-4M5 (with worst cable model (WCM3), EQ with 8 dB CTLE and One-tap DFE)

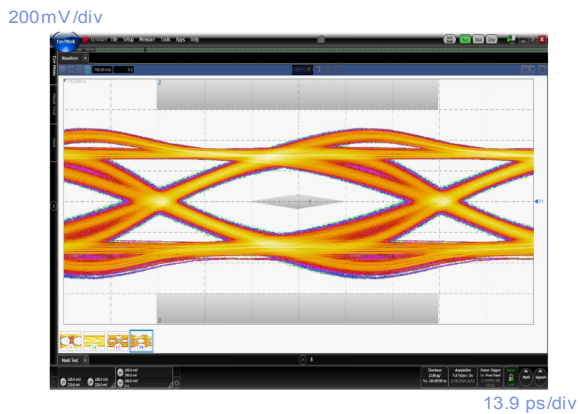

Figure 6. HDMI2.1 12 Gbps eye diagram with HSP05x-4M5 (with worst cable model (WCM3), EQ with 8 dB CTLE and One-tap DFE)

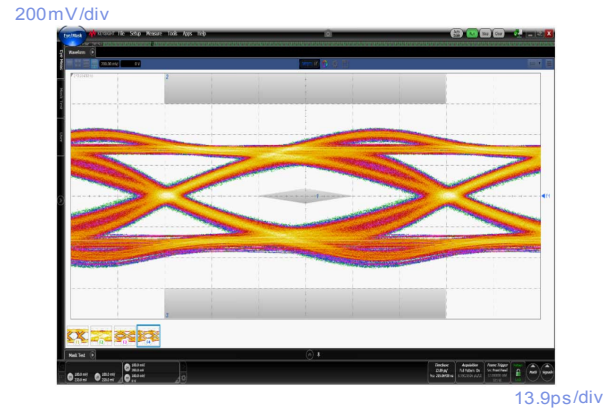
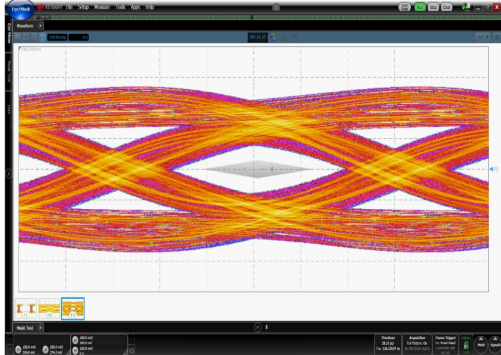

Figure 7. HDMI2.0 5.94 Gbps eye diagram without HSP05x-4M5 (with worst cable model and equalizer)

250mV/div



28.1ps/div

Figure 8. HDMI2.0 5.94 Gbps eye diagram with HSP05x-4M5 (with worst cable model and equalizer)

250mV/div

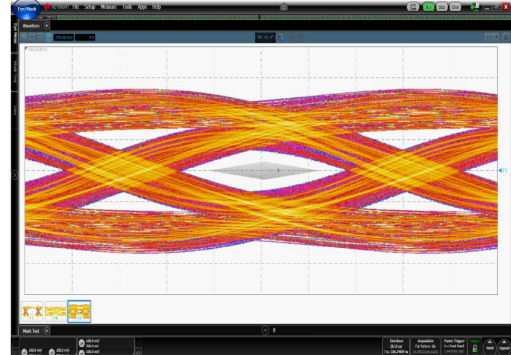

28.1ps/div

Figure 9. USB4 20Gbps eye diagram at TP3, without HSP05x-4M5, Preset0 + ref cable 0.8m + CTLE 0dB + DFE

200mV/div

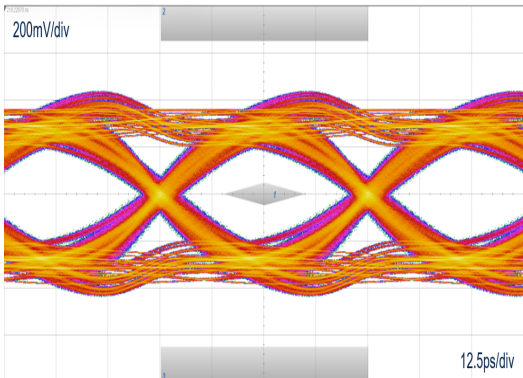

12.5ps/div

Figure 10. USB4 20Gbps eye diagram at TP3, with HSP05x-4M5, Preset0 + ref cable 0.8m + CTLE 0dB + DFE

200mV/div

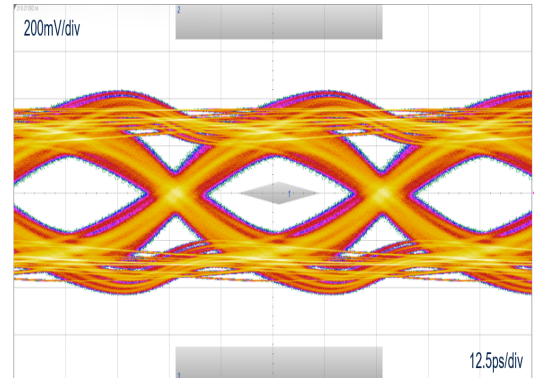

12.5ps/div

Figure 11. USB 3.2 Gen 2 10.0 Gbps eye diagram without HSP05x-4M5 (with type C connector, reference cable, equalizer with ADC = 6 dB and DFE)

100mV/div

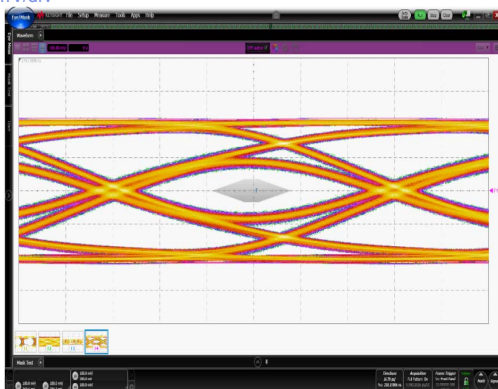

16.7ps/div

Figure 12. USB 3.2 Gen 2 10.0 Gbps eye diagram with HSP05x-4M5 (with type C connector, reference cable, equalizer with ADC = 6 dB and DFE)

100mV/div

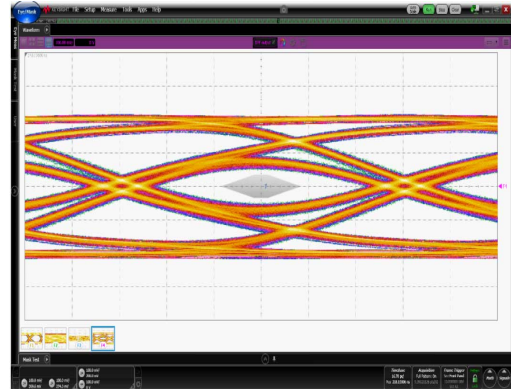

16.7ps/div

Figure 13. USB 3.2 Gen 1 5.0 Gbps eye diagram without HSP051-4M5 (with type C connector, reference cable and equalizer)

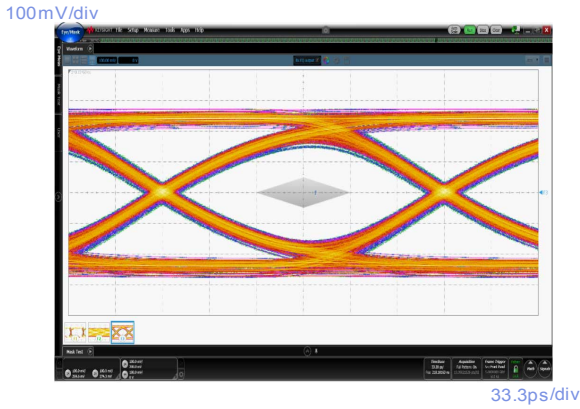

Figure 14. USB 3.2 Gen 1 10.0 Gbps eye diagram with HSP051-4M5 (with type C connector, reference cable and equalizer)

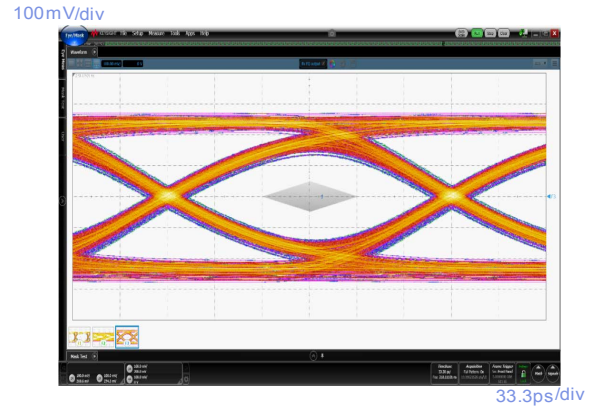

Figure 15. HSP051-4M5 ESD response to IEC61000-4-2 (+8 kV contact discharge)

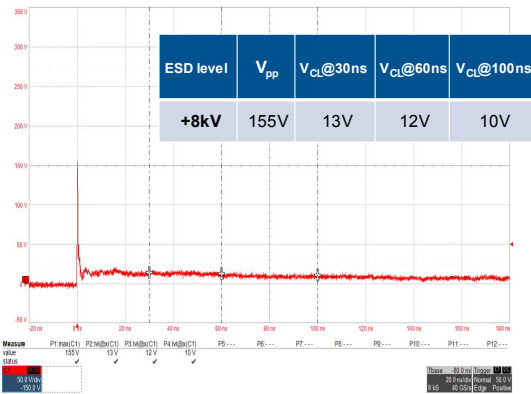

Figure 16. HSP051-4M5 ESD response to IEC61000-4-2 (-8 kV contact discharge)

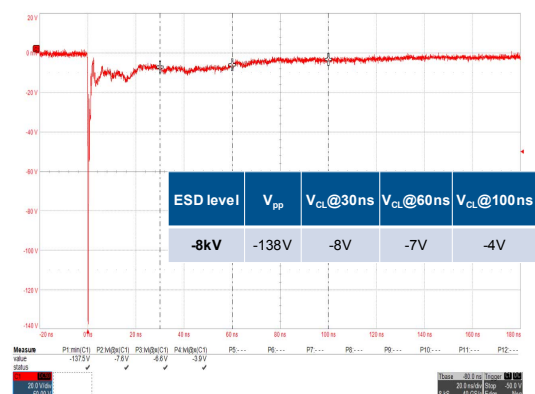

Figure 17. HSP053-4M5 ESD response to IEC61000-4-2 (+8 kV contact discharge)

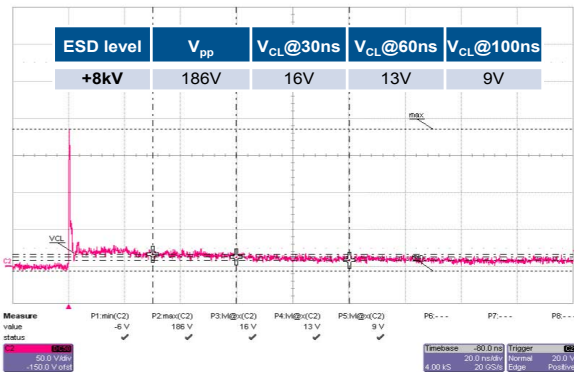

Figure 18. HSP053-4M5 ESD response to IEC61000-4-2 (-8 kV contact discharge)

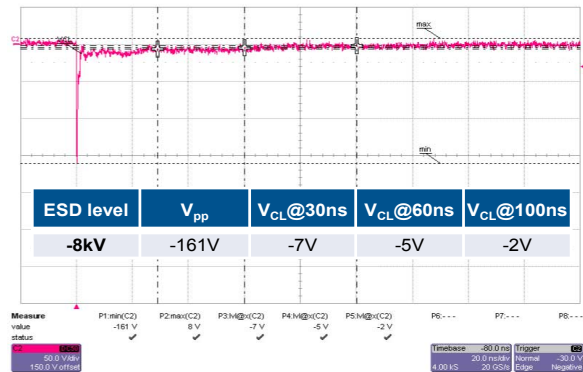

Figure 19. HSP051-4M5 TLP Characteristic (pulse duration 100 ns)

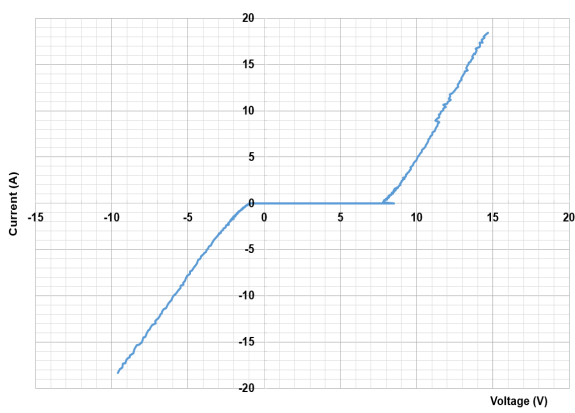

Figure 20. HSP053-4M5 TLP Characteristic (pulse duration 100 ns)

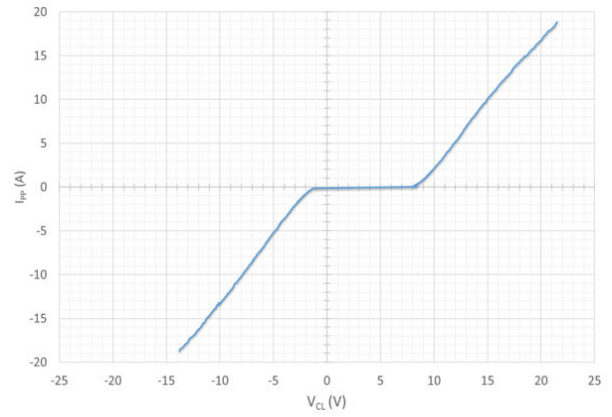
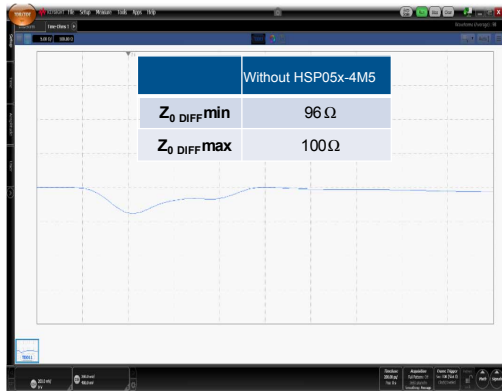

Figure 21. TDR measurement without HSP05x-4M5

5Ω/div



200ps/div

Figure 22. TDR measurement with HSP051-4M5

5Ω/div

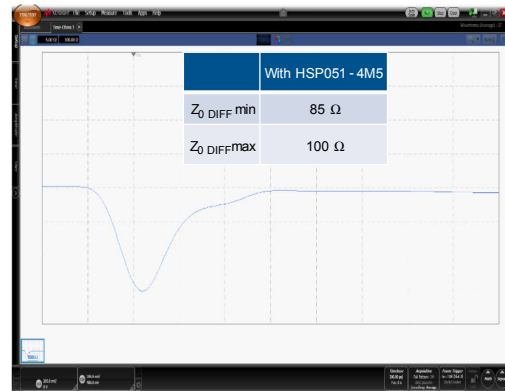

200ps/div

Figure 23. TDR measurement with HSP053-4M5



2 Package information

In order to meet environmental requirements, ST offers these devices in different grades of **ECOPACK** packages, depending on their level of environmental compliance. ECOPACK specifications, grade definitions and product status are available at: www.st.com. ECOPACK is an ST trademark.

2.1 MicroQFN-5L package information

Figure 24. MicroQFN-5L package outline

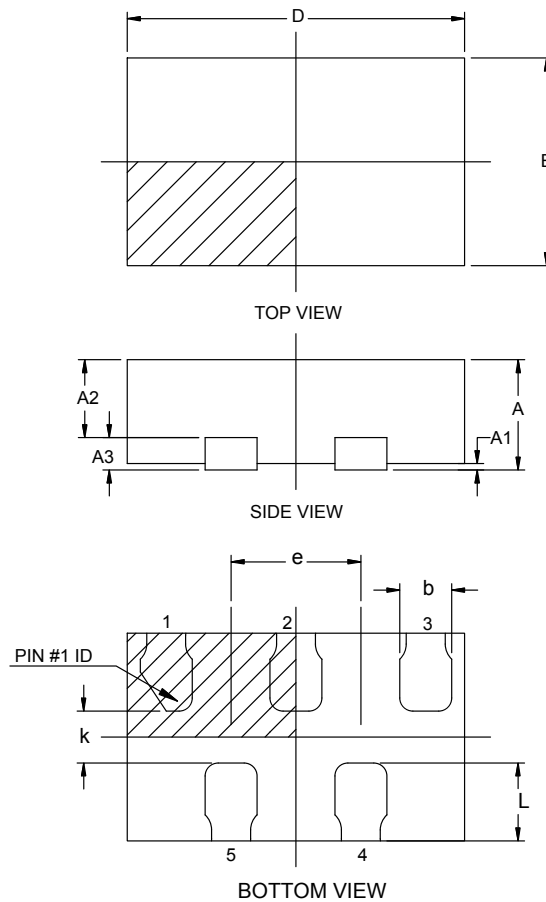

Table 3. MicroQFN-5L package mechanical data

Ref.	Dimensions					
	Millimeters			Inches		
	Min.	Typ.	Max.	Min.	Typ.	Max.
A	0.31	0.38	0.40	0.012	0.015	0.016
A1	0.00	0.02	0.05	0.000	0.001	0.002
A2	0.15	0.25	0.35	0.005	0.010	0.014
A3		0.130			0.005	
b	0.15	0.20	0.25	0.005	0.008	0.010
D	1.20	1.30	1.40	0.047	0.051	0.056
e		0.50			0.020	
E	0.70	0.80	0.90	0.027	0.031	0.036
L	0.20	0.25	0.30	0.007	0.010	0.012
k	0.20	0.25		0.007	0.010	

Figure 25. Footprint (dimensions in mm)

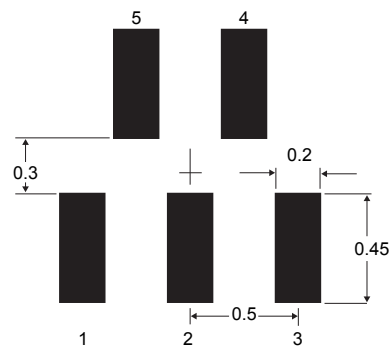

Figure 26. HSP051-4M5 marking



Figure 27. HSP053-4M5 marking

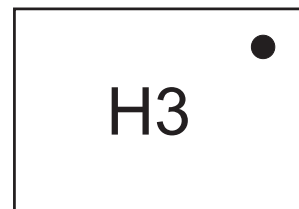
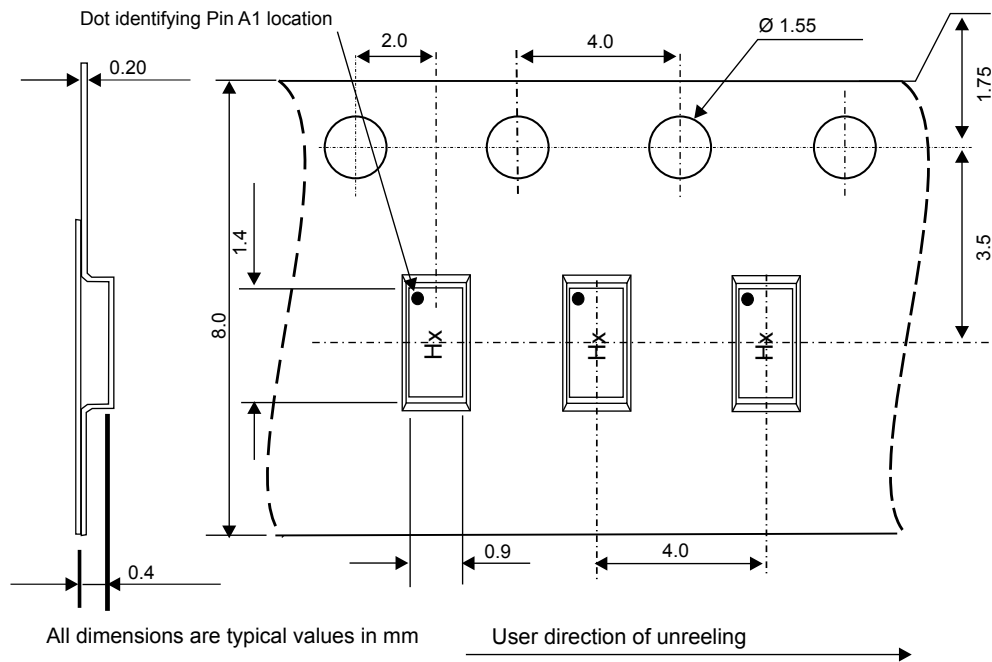

Figure 28. Tape and reel specification



3 Recommendation on PCB assembly

3.1 Solder paste

1. Halide-free flux qualification ROL0 according to ANSI/J-STD-004.
2. “No clean” solder paste is recommended.
3. Offers a high tack force to resist component movement during high speed.
4. Solder paste with fine particles: powder particle size is 20-45 μm .

3.2 Placement

1. Manual positioning is not recommended.
2. It is recommended to use the lead recognition capabilities of the placement system, not the outline centering
3. Standard tolerance of ± 0.05 mm is recommended.
4. 3.5 N placement force is recommended. Too much placement force can lead to squeezed out solder paste and cause solder joints to short. Too low placement force can lead to insufficient contact between package and solder paste that could cause open solder joints or badly centered packages.
5. To improve the package placement accuracy, a bottom side optical control should be performed with a high resolution tool.
6. For assembly, a perfect supporting of the PCB (all the more on flexible PCB) is recommended during solder paste printing, pick and place and reflow soldering by using optimized tools.

3.3 PCB design preference

1. To control the solder paste amount, the closed via is recommended instead of open vias.
2. The position of tracks and open vias in the solder area should be well balanced. A symmetrical layout is recommended, to avoid any tilt phenomena caused by asymmetrical solder paste due to solder flow away.

3.4 Reflow profile

Figure 29. ST ECOPACK® recommended soldering reflow profile for PCB mounting

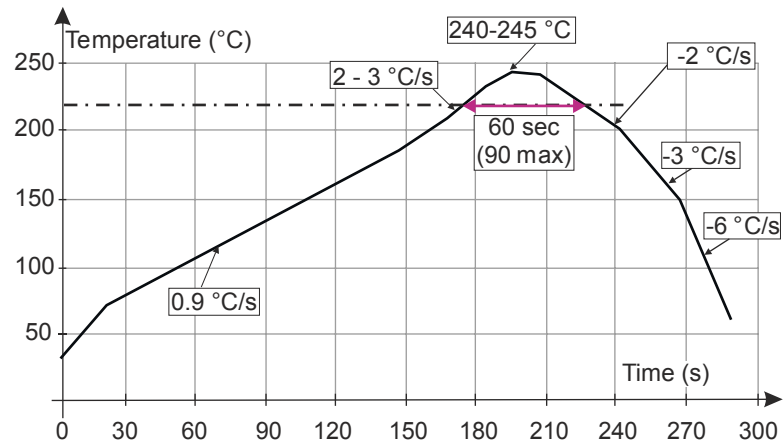

Note: Minimize air convection currents in the reflow oven to avoid component movement.

Note: Maximum soldering profile corresponds to the latest IPC/JEDEC J-STD-020.

4 Ordering information

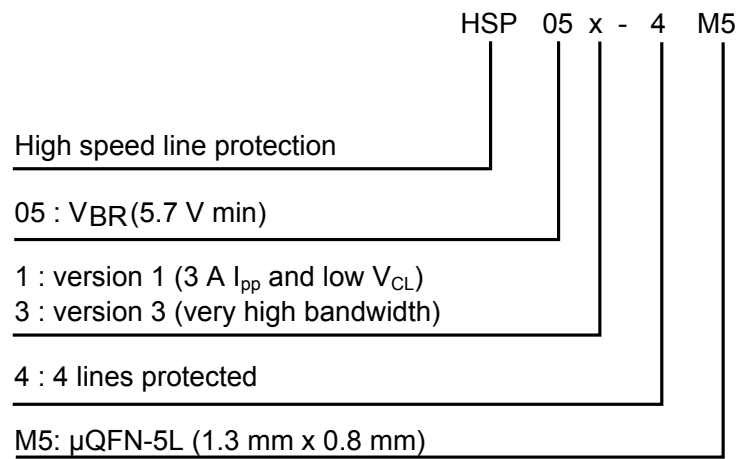
Figure 30. Ordering information scheme

Table 4. Ordering information

Order code	Marking ⁽¹⁾	Package	Weight	Base qty.	Delivery mode
HSP051-4M5	H1	μ QFN-5L	1.04 mg	6000	Tape and reel
HSP053-4M5	H3				

1. The marking can be rotated by multiples of 90° to differentiate assembly location

Revision history

Table 5. Document revision history

Date	Revision	Changes
04-Feb-2016	1	Initial release.
21-Dec-2018	2	New version of product.
07-Feb-2019	3	Updated link syntax.
07-Nov-2022	4	Merged HSP051-4M5 with HSP053-4M5. Minor text changes.
14-Apr-2023	5	Updated Table 2 .

IMPORTANT NOTICE – READ CAREFULLY

STMicroelectronics NV and its subsidiaries (“ST”) reserve the right to make changes, corrections, enhancements, modifications, and improvements to ST products and/or to this document at any time without notice. Purchasers should obtain the latest relevant information on ST products before placing orders. ST products are sold pursuant to ST’s terms and conditions of sale in place at the time of order acknowledgment.

Purchasers are solely responsible for the choice, selection, and use of ST products and ST assumes no liability for application assistance or the design of purchasers’ products.

No license, express or implied, to any intellectual property right is granted by ST herein.

Resale of ST products with provisions different from the information set forth herein shall void any warranty granted by ST for such product.

ST and the ST logo are trademarks of ST. For additional information about ST trademarks, refer to www.st.com/trademarks. All other product or service names are the property of their respective owners.

Information in this document supersedes and replaces information previously supplied in any prior versions of this document.

© 2023 STMicroelectronics – All rights reserved