

QT-Brightek Lamp Series
5mm Through Hole Lamp
Part No.: QBL8SA40D

Product: QBL8SA40D	Date: September 22, 2014	Page 1 of 8
	Version# 1.0	

Table of Contents

Introduction	3
Electrical / Optical Characteristic (T=25 °C)	4
Absolute Maximum Rating	4
Characteristic Curves.....	5
Packing	7
Labeling	7
Ordering Information	7
Revision History	8
Disclaimer	8

Introduction

Feature:

- Red Diffused lens
- Packed in tape and reel
- Super bright 5mm round type TH lamp
- AlGaAs technology
- 40 °viewing angle
- Bulk Pack

Description:

These super bright 5mm round type TH lamps with 8.7mm lens height are suitable for all applications requiring higher brightness.

Application:

- General purpose indicator application
- Electronic signs and electronics board
- LED lighting

Certification & Compliance:

- TS16949
- ISO9001
- RoHS Compliant

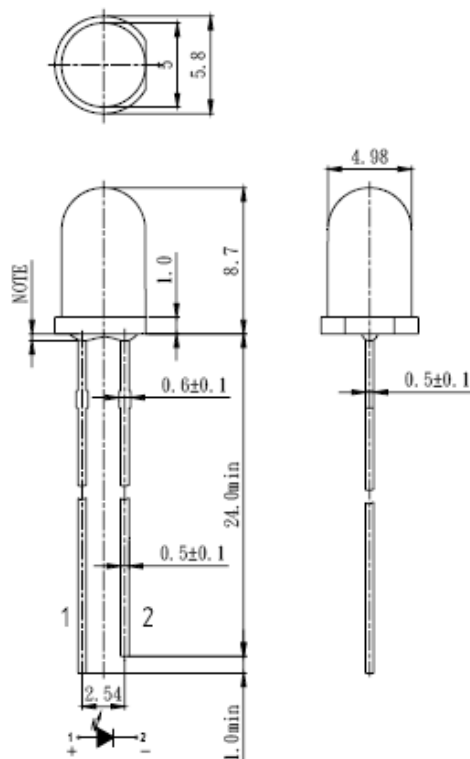
**Dimension:**

Units: mm / tolerance = +/-0.3mm

Electrical / Optical Characteristic (T=25 °C)

Product	Color	I _F (mA)	V _F (V)		λ _D (nm)			I _V (mcd)	
			Typ.	max	Min	Typ.	Max.	min	typ.
QBL8SA40D	Red	20	2.0	2.5	630	-	650	18	60

Absolute Maximum Rating

Material	P _d (mW)	I _F (mA)	V _R (V)	T _{OP} (°C)	T _{ST} (°C)
AlGaAs	80	30	5	-30 to + 80	-40 to +100

*Duty 1/10 @ 1KHz

** Wave Soldering for no more than 5 sec @ 260 °C

Characteristic Curves

AlGaAs

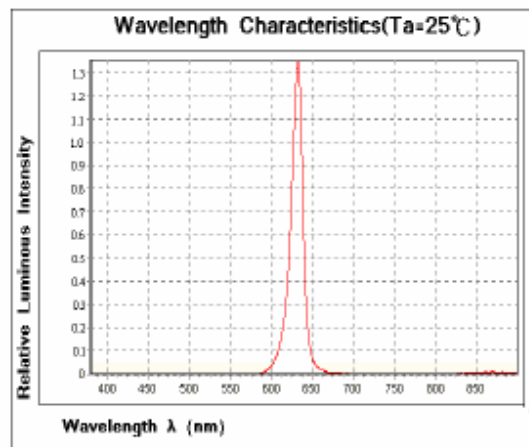
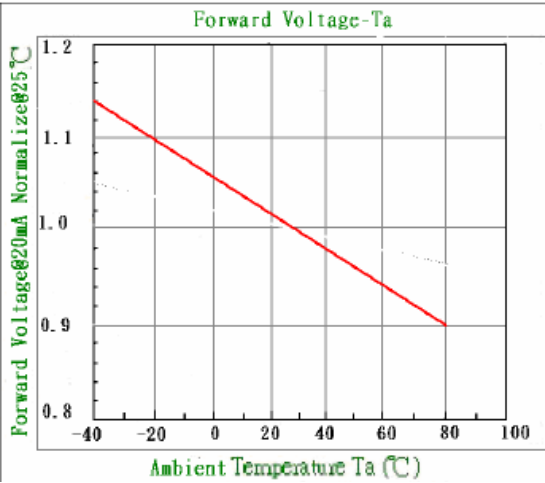
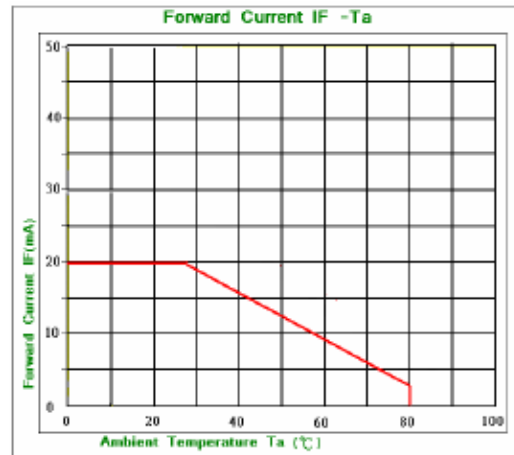
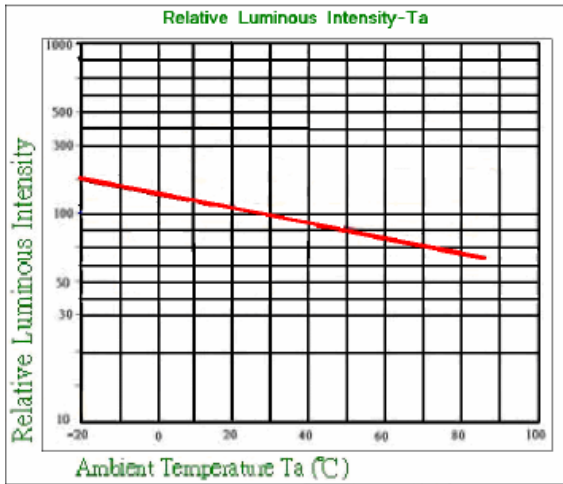
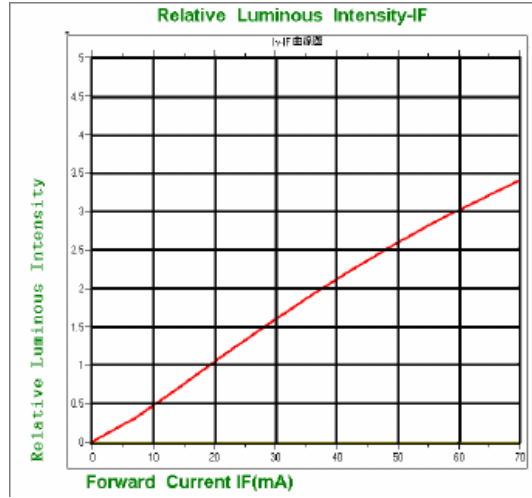
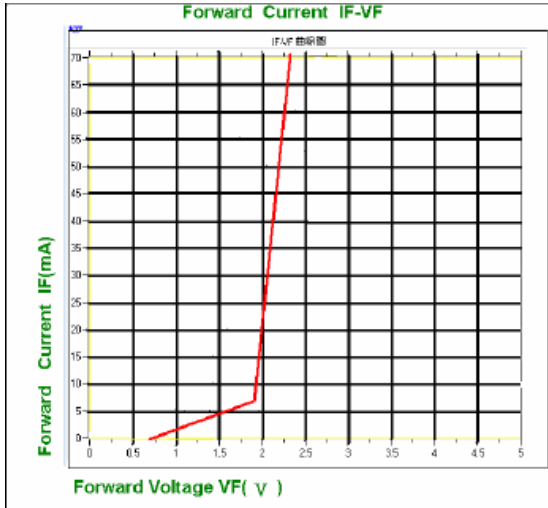

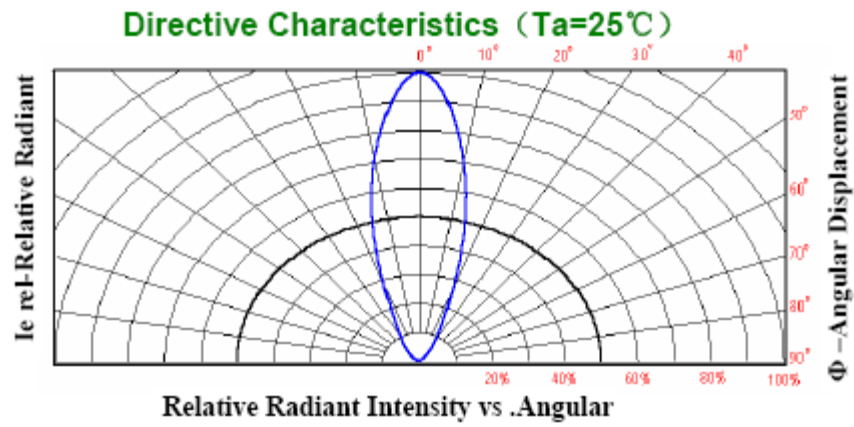

Packing
Bulk Pack 500pcs

Labeling



Part No: _____

Customer Lot No: _____

Item: _____

Q'ty: _____

Vf: _____

Iv: _____

Date: _____

ROHS PASS

Ordering Information

Part #	Orderable Part #	Spec Range	Quantity per bag
QBL8SA40D	QBL8SA40D	Iv = 60mc typ., Wd = 645nm	500 pc

Revision History

Description:	Revision #	Revision Date
New Release of QBL8SA40D	V1.0	09/22/2014

Disclaimer

QT-BRIGHTTEK reserves the right to make changes without further notice to any products herein to improve reliability, function or design. QT-BRIGHTTEK does not assume any liability arising out of the application or use of any product or circuit described herein; neither does it convey any license under its patent rights, nor the rights of others.

Life Support Policy

QT-BRIGHTTEK's products are not authorized for use as critical components in life support devices or systems without the express written approval of QT-BRIGHTTEK. As used herein:

1. Life support devices or systems are devices or systems which, (a) are intended for surgical implant into the body, or (b) support or sustain life, and (c) whose failure to perform when properly used in accordance with instructions for use provided in the labeling, can be reasonably expected to result in a significant injury of the user.
2. A critical component in any component of a life support device or system whose failure to perform can be reasonably expected to cause the failure of the life support device or system, or to affect its safety or effectiveness.

Product: QBL8SA40D	Date: September 22, 2014	Page 8 of 8
	Version# 1.0	