

# AC charging cable - EV-T1G2C-1AC32A-25FT10ASBK11 - 1628379

Please be informed that the data shown in this PDF Document is generated from our Online Catalog. Please find the complete data in the user's documentation. Our General Terms of Use for Downloads are valid (<http://phoenixcontact.com/download>)



AC charging cable, AC charging cable with Vehicle Connector, open cable end, with protective cap, C-Line black / black, Type 1, SAE J1772, IEC 62196-2, 32 A / 250 V (AC), design line C-Line, cable: 25 ft, black, straight, NOTE: Cable management may be required., mating face: black, handle area: black

## Product Description

AC charging cable with Vehicle Connector and open cable end for charging electric vehicles (EV) with alternating current (AC) via type 1 Vehicle Inlets, for installation at charging stations for E-Mobility (EVSE)

## Your advantages

- ✔ Consistent design of all Phoenix Contact Vehicle Connectors and Infrastructure Plugs
- ✔ Silver-plated surface of the power and signal contacts
- ✔ Certified in accordance with IATF 16949:2016 and ISO 9001:2015
- ✔ Convenient handling, thanks to the ergonomic handle and additional, rubber grip components
- ✔ Tested in accordance with selected tests of automotive standards LV124, LV214, LV215-2
- ✔ Reliable function of the locking lever with additional seal
- ✔ Optional locking option with a U-lock
- ✔ Consistent longitudinal water tightness prevents water ingress in the cable



## Key Commercial Data

Packing unit	1 pc
GTIN	 4 055626 476889
GTIN	4055626476889

## Technical data

### Product definition

Product type	AC charging cable with Vehicle Connector, open cable end, with protective cap
Type	C-Line black / black
Standards/regulations	SAE J1772
	IEC 62196-2
Charging standard	Type 1

# AC charging cable - EV-T1G2C-1AC32A-25FT10ASBK11 - 1628379

## Technical data

### Product definition

Charging mode	Level 2
Note	NOTE: Cable management may be required.
	Cable management is required in certain regions if the cable length exceeds 5.0 m (Switzerland) or 7.5 m (USA) (IEC 61851-1).

### Dimensions

Vehicle connector width	58.00 mm
Vehicle connector height	151.10 mm
Vehicle connector depth	236.10 mm
Conductor length	25 ft
Stripping length	60 mm ±15 mm

### Ambient conditions

Ambient temperature (operation)	-30 °C ... 50 °C
Ambient temperature (storage/transport)	-40 °C ... 80 °C
Max. altitude	5000 m (above sea level)
Degree of protection	3R (plugged in; when plugged in and ready to operate, the degree of protection is only ensued if both plug-in components are original products from Phoenix Contact or suitable standard-compliant products)

### Electrical properties

Maximum charging power	8 kW
Number of phases	1
Number of power contacts	3 (L1, N, PE)
Rated current of power contacts	32 A
Rated voltage for power contacts	250 V AC
Number of signal contacts	2 (CP, CS)
Rated current for signal contacts	2 A
Rated voltage for signal contacts	30 V AC
Type of signal transmission	Pulse width modulation
Note on the connection method	Crimp connection, cannot be disconnected
Resistor coding	480 Ω (Lever actuated)
	150 Ω (Lever not actuated)

### Mechanical properties

Insertion/withdrawal cycles	> 10000
Insertion force	< 75 N
Withdrawal force	< 75 N

### Design

Design line	C-Line
Housing color	black
Mating face color	black
Color handle area	black

# AC charging cable - EV-T1G2C-1AC32A-25FT10ASBK11 - 1628379

## Technical data

### Design

Actuating element color	silver
Color protective cap	black
Customer variations	On request

### Material

Housing material	Plastic
Material handle area	Soft plastic
Actuating lever material	Metal
Material protective cap	Soft plastic
Material mating face	Plastic
Flammability rating	V0
Material surface of contacts	Ag

### Cable

Cable structure	3 x 10 AWG + 1 x 18 AWG
Wiring standards/regulations	UL 62
	FFSO7.E343212
External cable diameter	17 mm ±0.4 mm
Type of conductor	straight
Outer sheath, material	TPE
External sheath, color	black
Minimum bending radius	255 mm (15 x diameter)

### Locking

Locking type	No locking option for U-lock
--------------	------------------------------

### Environmental Product Compliance

REACH SVHC	Lead 7439-92-1
China RoHS	Environmentally Friendly Use Period = 10;
	For details about hazardous substances go to tab "Downloads", Category "Manufacturer's declaration"

### Drawings

# AC charging cable - EV-T1G2C-1AC32A-25FT10ASBK11 - 1628379

Connection diagram

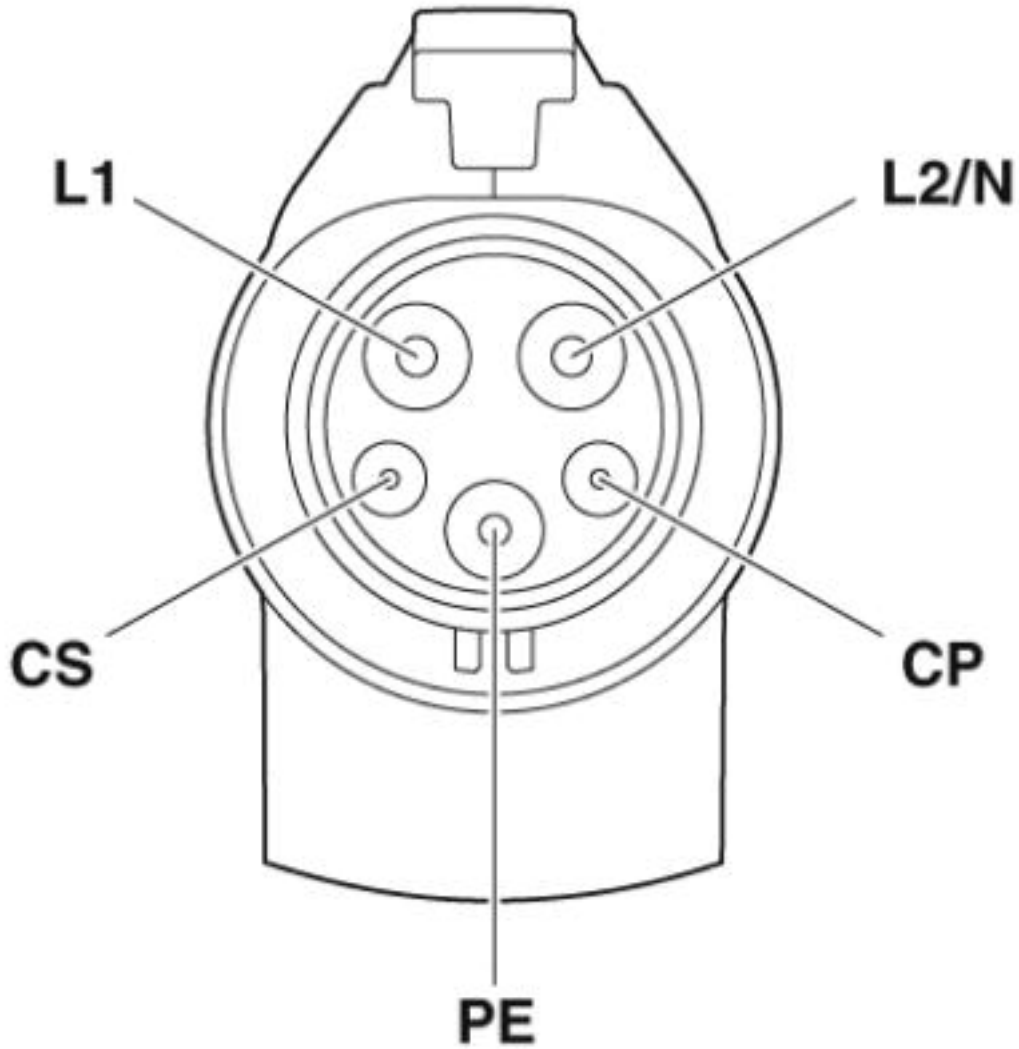

Pin assignment of the Vehicle Connector

# AC charging cable - EV-T1G2C-1AC32A-25FT10ASBK11 - 1628379

Dimensional drawing

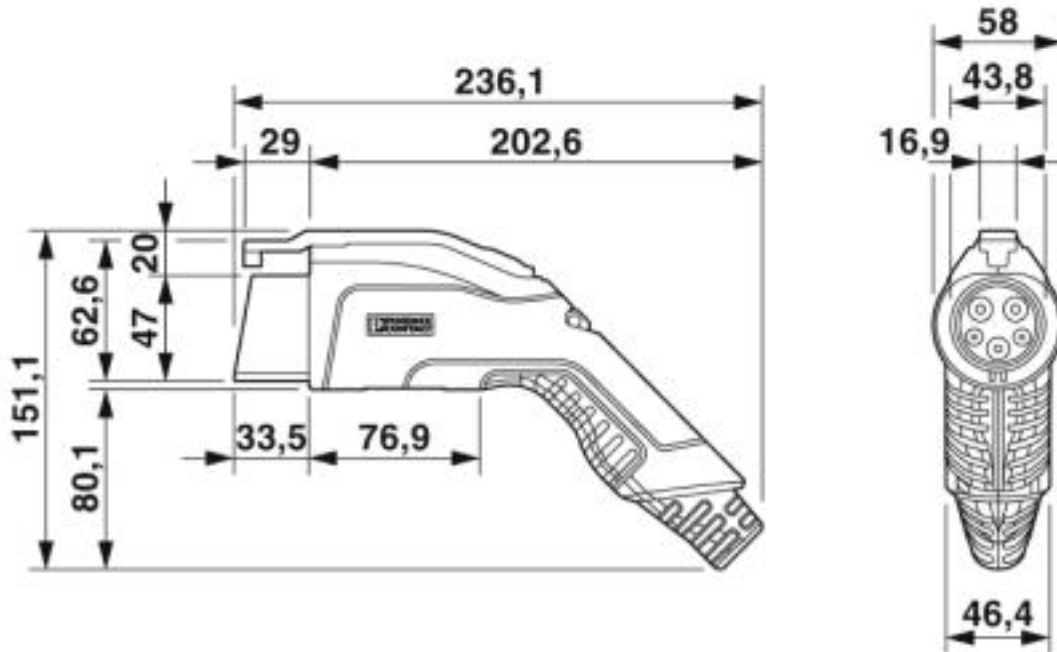

Ensure that the vehicle connector is placed in an appropriate resting position that ensures a minimum protection rating of IP24 in accordance with IEC 61851-1 for the entire time between charging. Use the dimensions of the vehicle connector to create this type of resting position. Detailed specifications can also be found in the download area.

Schematic diagram



Terminology definition

# AC charging cable - EV-T1G2C-1AC32A-25FT10ASBK11 - 1628379

Schematic diagram

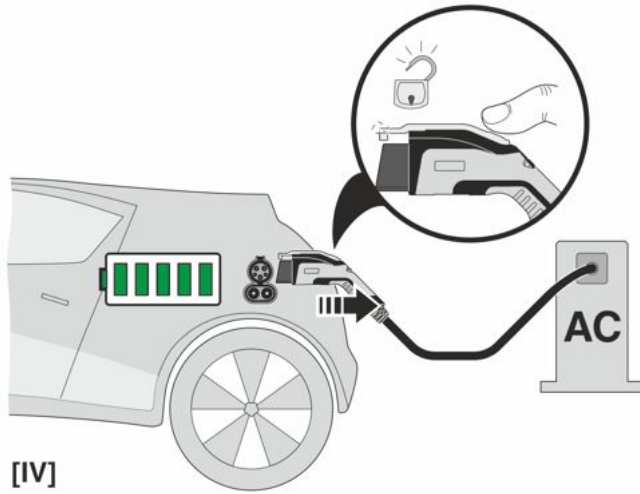
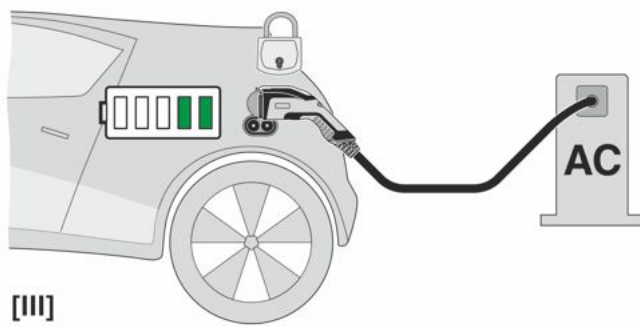
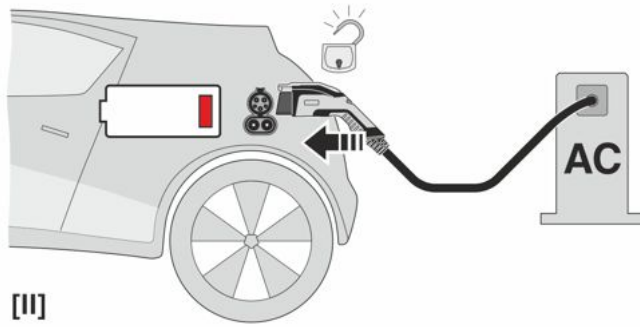

# AC charging cable - EV-T1G2C-1AC32A-25FT10ASBK11 - 1628379

## Approvals

### Approvals

---

#### Approvals

cULus Recognized

---

#### Ex Approvals

---

### Approval details

cULus Recognized  <a href="http://database.ul.com/cgi-bin/XYV/template/LISEXT/1FRAME/index.htm">http://database.ul.com/cgi-bin/XYV/template/LISEXT/1FRAME/index.htm</a> E473195-20160303	
Nominal voltage UN	250 V
Nominal current IN	32 A
mm <sup>2</sup> /AWG/kcmil	10

---

Phoenix Contact 2019 © - all rights reserved  
<http://www.phoenixcontact.com>

PHOENIX CONTACT GmbH & Co. KG  
Flachsmarktstr. 8  
32825 Blomberg  
Germany  
Tel. +49 5235 300  
Fax +49 5235 3 41200  
<http://www.phoenixcontact.com>