

## ALC70H272KP450

Aliases (A546KW272M450H)

ALC70, Aluminum Electrolytic, 2,700 uF, 20%, 450 VDC, -40/+85°C

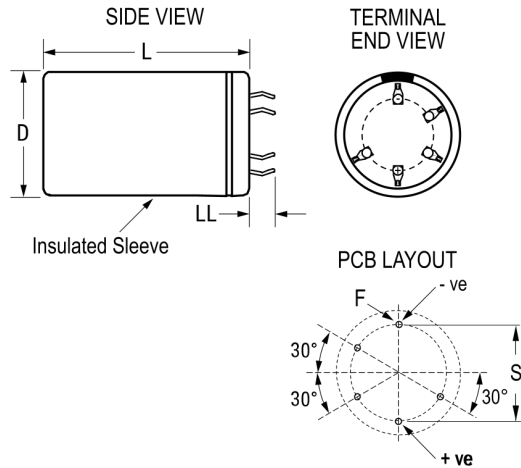

Click [here](#) for the 3D model.

### Dimensions

D	50mm +1mm
L	105mm +/-2mm
S	25mm +/-0.1mm
LL	4mm +/-1mm
F	2mm +/-0.1mm

### Packaging Specifications

Sleeving	Yes
Packaging	Bulk, Bag

### General Information

Series	ALC70
Dielectric	Aluminum Electrolytic
Description	Snap-In, Aluminum Electrolytic
RoHS	Yes
Lead	5 Pin Short
AEC-Q200	No
Halogen Free	Yes
Component Weight	310 g
Notes	Dimensions D And L Include Sleeving.
Shelf Life	156 Weeks

### Specifications

Capacitance	2,700 uF
Capacitance Tolerance	20%
Voltage DC	450 VDC, 495 VDC (Surge)
Temperature Range	-40/+85°C
Rated Temperature	85°C
Life	18000 Hrs (Rated Voltage and Ripple Current at 85C), 29000 Hrs (Rated Voltage at 85C)
Resistance	52.66 mOhms (100Hz 20C), 31.03 mOhms (10kHz 20C)
Ripple Current	8.455 Amps (100Hz 85C), 15.99 Amps (10kHz 85C)
Leakage Current	6000 uA (5min 20°C)