



LED Display Product Data Sheet LTC-4857E

Spec No.: DS30-2000-101

Effective Date: 05/27/2000

Revision: -

LITE-ON DCC

RELEASE

BNS-OD-FC001/A4

FEATURES

- * 0.4 inch (10.21- mm) DIGIT HEIGHT.
- * CONTINUOUS UNIFORM SEGMENTS.
- * LOW POWER REQUIREMENT.
- * EXCELLENT CHARACTERS APPEARANCE.
- * HIGH BRIGHTNESS & HIGH CONTRAST.
- * WIDE VIEWING ANGLE.
- * SOLID STATE RELIABILITY.
- * CATEGORIZED FOR LUMINOUS INTENSITY.

DESCRIPTION

The LTC-4857E is a 0.4 inch (10.21-mm) digit height triple digit seven-segment display. This device utilizes red orange LED chips, which are made from GaAsP on GaP substrate, and has a gray face and white segments.

DEVICE

PART NO.	DESCRIPTION
RED ORANGE	COMMON ANODE
LTC-4857E	

PACKAGE DIMENSIONS

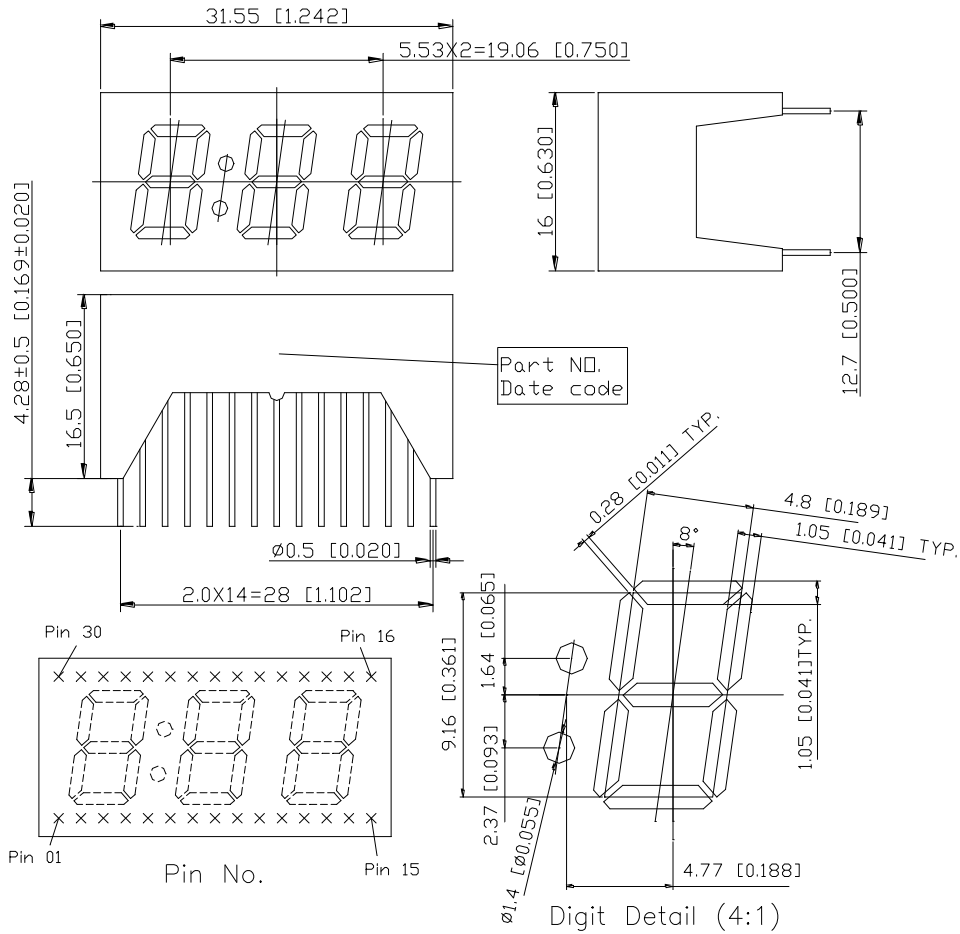

NOTES: All dimensions are in millimeters. Tolerances are ± 0.25 mm (0.01") unless otherwise noted.

INTERNAL CIRCUIT DIAGRAM

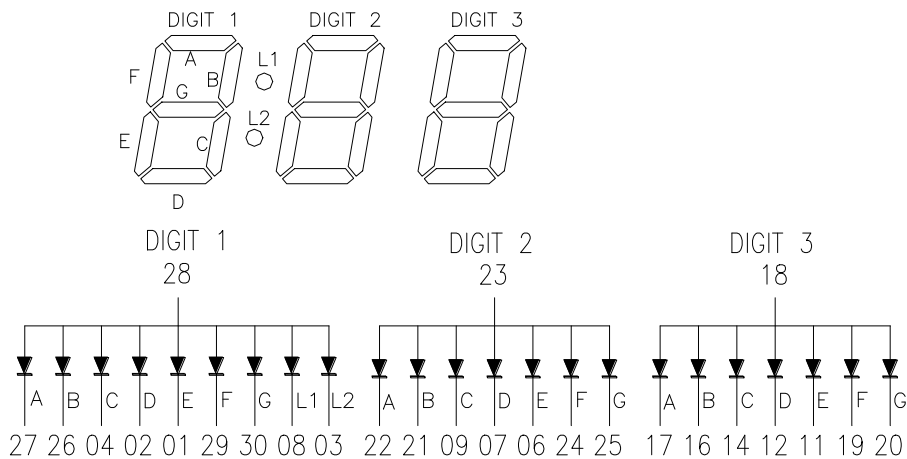

PIN CONNECTION

No.	CONNECTION	No.	CONNECTION
1	CATHODE E (DIGIT 1)	16	CATHODE B (DIGIT 3)
2	CATHODE D (DIGIT 1)	17	CATHODE A (DIGIT 3)
3	CATHODE L2 (DIGIT 1)	18	COMMON ANODE (DIGIT 3)
4	CATHODE C (DIGIT 1)	19	CATHODE F (DIGIT 3)
5	NO CONNECTION	20	CATHODE G (DIGIT 3)
6	CATHODE E (DIGIT 2)	21	CATHODE B (DIGIT 2)
7	CATHODE D (DIGIT 2)	22	CATHODE A (DIGIT 2)
8	CATHODE L1 (DIGIT 1)	23	COMMON ANODE (DIGIT 2)
9	CATHODE C (DIGIT 2)	24	CATHODE F (DIGIT 2)
10	NO CONNECTION	25	CATHODE G (DIGIT 2)
11	CATHODE E (DIGIT 3)	26	CATHODE B (DIGIT 1)
12	CATHODE D (DIGIT 3)	27	CATHODE A (DIGIT 1)
13	NO CONNECTION	28	COMMON ANODE (DIGIT 1)
14	CATHODE C (DIGIT 3)	29	CATHODE F (DIGIT 1)
15	NO CONNECTION	30	CATHODE G (DIGIT 1)

ABSOLUTE MAXIMUM RATING AT Ta=25°C

PARAMETER	MAXIMUM RATING	UNIT
Power Dissipation Per Segment	75	mW
Peak Forward Current Per Segment (1/10 Duty Cycle, 0.1ms Pulse Width)	100	mA
Continuous Forward Current Per Segment Derating Linear From 25°C Per Segment	25 0.28	mA mA/°C
Reverse Voltage Per Segment	5	V
Operating Temperature Range	-35°C to +105°C	
Storage Temperature Range	-35°C to +105°C	
Solder Temperature: max 260°C for max 3sec at 1.6mm[1/16inch] below seating plane.		

ELECTRICAL / OPTICAL CHARACTERISTICS AT Ta=25°C

PARAMETER	SYMBOL	MIN.	TYP.	MAX.	UNIT	TEST CONDITION
Average Luminous Intensity	I _v	800	2200		μcd	I _F =10mA
Peak Emission Wavelength	λ _p		630		nm	I _F =20mA
Spectral Line Half-Width	Δλ		40		nm	I _F =20mA
Dominant Wavelength	λ _d		621		nm	I _F =20mA
Forward Voltage Per Segment	V _F		2.0	2.6	V	I _F =20mA
Reverse Current Per Segment	I _R			100	μA	V _R =5V
Luminous Intensity Matching Ratio	I _v -m			2:1		I _F =10mA

Note: Luminous intensity is measured with a light sensor and filter combination that approximates the CIE (Commision Internationale De L'Eclairage) eye-response curve.

TYPICAL ELECTRICAL / OPTICAL CHARACTERISTIC CURVES

(25°C Ambient Temperature Unless Otherwise Noted)

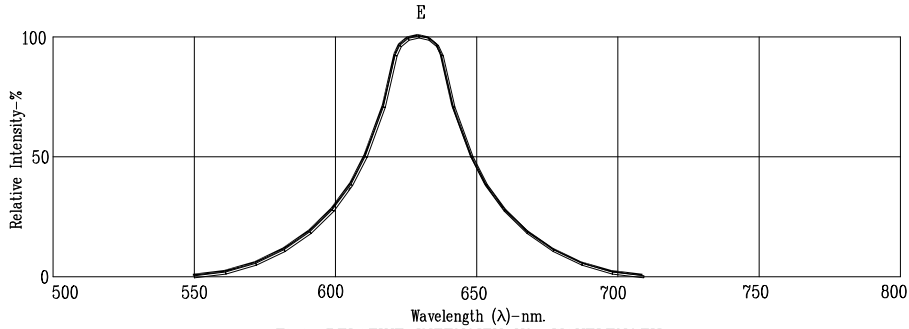

Fig1. RELATIVE INTENSITY VS. WAVELENGTH

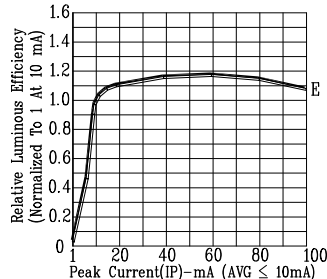

Fig4. RELATIVE LUMINOUS EFFICIENCY (LUMINOUS INTENSITY PER UNIT CURRENT) VS. PEAK CURRENT (REFRESH RATE 1KHz)

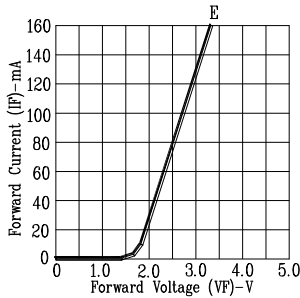

Fig2. FORWARD CURRENT VS. FORWARD VOLTAGE

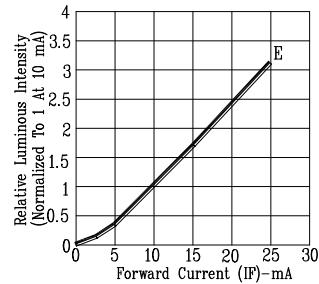

Fig3. RELATIVE LUMINOUS INTENSITY VS. FORWARD CURRENT

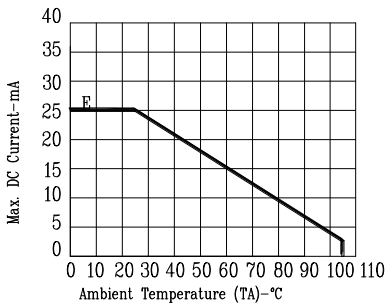

Fig8. MAX. ALLOWABLE DC CURRENT VS. AMBIENT TEMPERATURE.

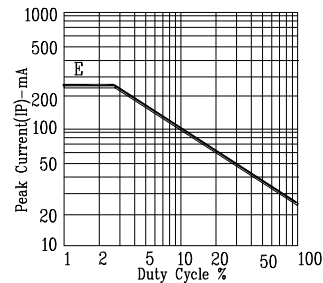

Fig9. MAX. PEAK CURRENT VS. DUTY CYCLE % (REFRESH RATE 1KHz)

NOTE: E=RED ORANGE