

# Pharaoh

SR4L073 • lamiiANT<sup>®</sup>

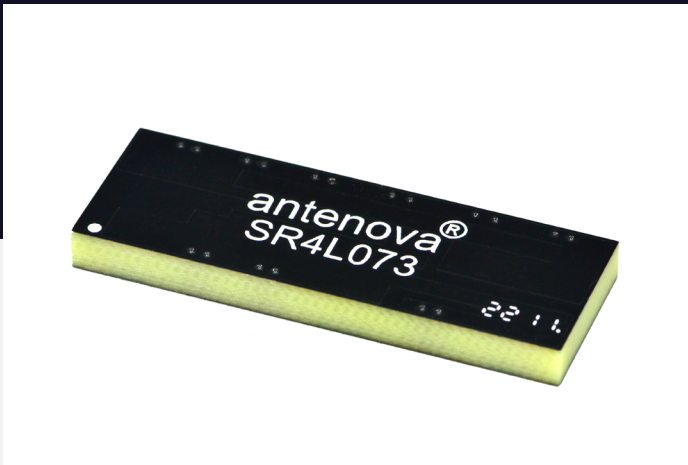

## Features

- Antenna for cellular 4G/LTE applications
- Has good efficiency on a small PCB size
- Centre, off-centre or corner placement
- Suitable for high volume manufacturing
- High performance: DFI (Designed For Integration)
- Evaluation PCB size: 60x40mm

# Contents

<b>1.</b>	<b>Description</b>	<b>2</b>
<b>2.</b>	<b>Applications</b>	<b>2</b>
<b>3.</b>	<b>General data</b>	<b>2</b>
<b>4.</b>	<b>Part number</b>	<b>3</b>
<b>5.</b>	<b>RF characteristics</b>	<b>3</b>
<b>6.</b>	<b>RF performance</b>	<b>4</b>
<b>6.1.</b>	Return loss	4
<b>6.2.</b>	VSWR	4
<b>6.3.</b>	Efficiency	5
<b>6.4.</b>	Antenna pattern	6
<b>7.</b>	<b>Antenna dimensions</b>	<b>11</b>
<b>8.</b>	<b>Schematic symbol and pin definition</b>	<b>12</b>
<b>9.</b>	<b>Host PCB footprint</b>	<b>12</b>
<b>10.</b>	<b>Electrical interface</b>	<b>13</b>
<b>10.1.</b>	Transmission line	13
<b>10.2.</b>	Matching circuit	13
<b>11.</b>	<b>Antenna integration guide</b>	<b>14</b>
<b>11.1.</b>	Antenna placement	14
<b>11.2.</b>	Host PCB layout	15
<b>11.3.</b>	Host PCB clearance	15
<b>12.</b>	<b>Reference board</b>	<b>16</b>
<b>12.1.</b>	Reference board matching circuit	16
<b>13.</b>	<b>Soldering</b>	<b>17</b>
<b>14.</b>	<b>Hazardous material regulation conformance</b>	<b>17</b>
<b>15.</b>	<b>Packaging</b>	<b>17</b>
<b>15.1.</b>	Optimal storage conditions	17
<b>15.2.</b>	Tape characteristics	18
<b>15.3.</b>	Reel dimensions	19
<b>15.4.</b>	Box dimensions	19
<b>15.5.</b>	Bag properties	20
<b>15.6.</b>	Reel label information	20

## 1. Description

---

A SMD antenna for fitting onto a PCB. The antenna operates on the most common 4G bands: LTE 700, GSM850, GSM900, DCS1800, PCS1900, WCDMA2100, LTE B7 (2500-2690MHz), and LTE B40 (2300 – 2400MHz).

## 2. Applications

---

- Telematics and OBD tracking devices
- Pet Trackers
- Wearables such as Fitness bands
- Bike Trackers
- M2M (Machine to Machine) / Remote monitoring
- POS (Point of Sale) terminals
- Small sensors for IoT (Internet of Things)
- Drone communications

## 3. General data

---

FREQUENCY	698-824MHz 824-960MHz 1710-2200MHz 2300-2400MHz 2500-2690MHz
POLARIZATION	Linear
OPERATING TEMPERATURE	-40°C to 140°C
ENVIRONMENTAL CONDITION TEST	ISO16750-4 5.1.1.1/5.1.2.1/5.3.2
IMPEDANCE WITH MATCHING	50 Ω
WEIGHT	<3.4g
ANTENNA TYPE	SMD
DIMENSIONS	37.0 x 13.0 x 3.3 (mm)

## 4. Part number

PHARAOH  
SR4L073



## 5. RF characteristics

All data measured on Antenna's evaluation PCB Part No. SR4L073-EVB-1 (EVK size 60mm x 40mm)

	698-824MHZ	824-960MHZ	1710-2170MHZ
PEAK GAIN	-1.4dBi	-0.1dBi	2.9dBi
AVERAGE GAIN (LINEAR)	-6.0dBi	-4.5dBi	-1.0dBi
AVERAGE EFFICIENCY	>25%	>35%	>80%
MAXIMUM RETURN LOSS	-4.6dB	-6.4dB	-11.3dB
MAXIMUM VSWR	3.8:1	2.8:1	1.7:1

	2300-2400MHZ	2500-2690MHZ
PEAK GAIN	2.6dBi	2.9dBi
AVERAGE GAIN (LINEAR)	-1.7dBi	-2.1dBi
AVERAGE EFFICIENCY	>65%	>60%
MAXIMUM RETURN LOSS	-8.5dB	-8.5dB
MAXIMUM VSWR	2.2:1	2.2:1

## 6. RF performance

### 6.1. Return loss

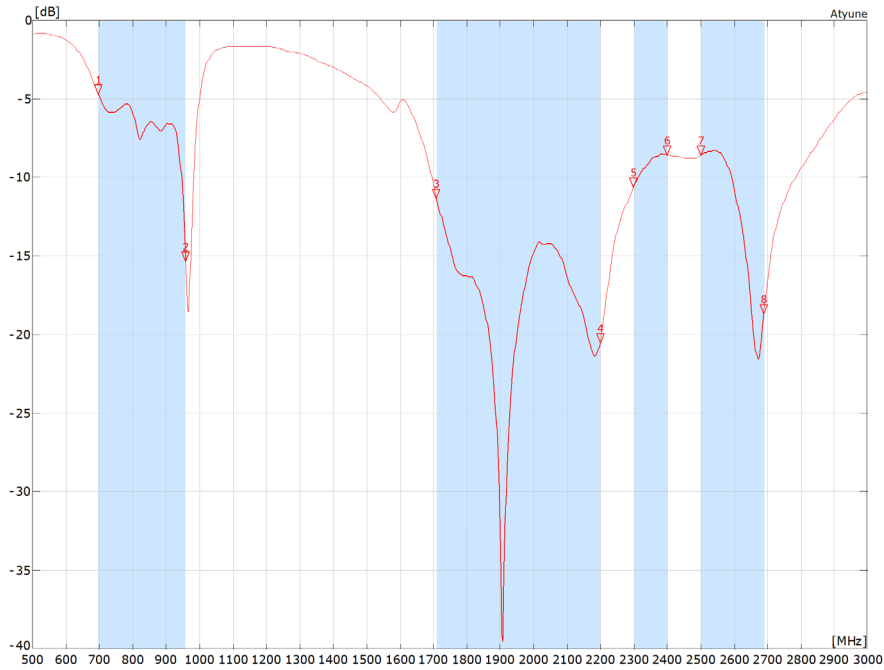

All data measured on Antenna's evaluation PCB Part No. SR4L073-EVB-1 (EVK size 60mm x 40mm)

### 6.2. VSWR

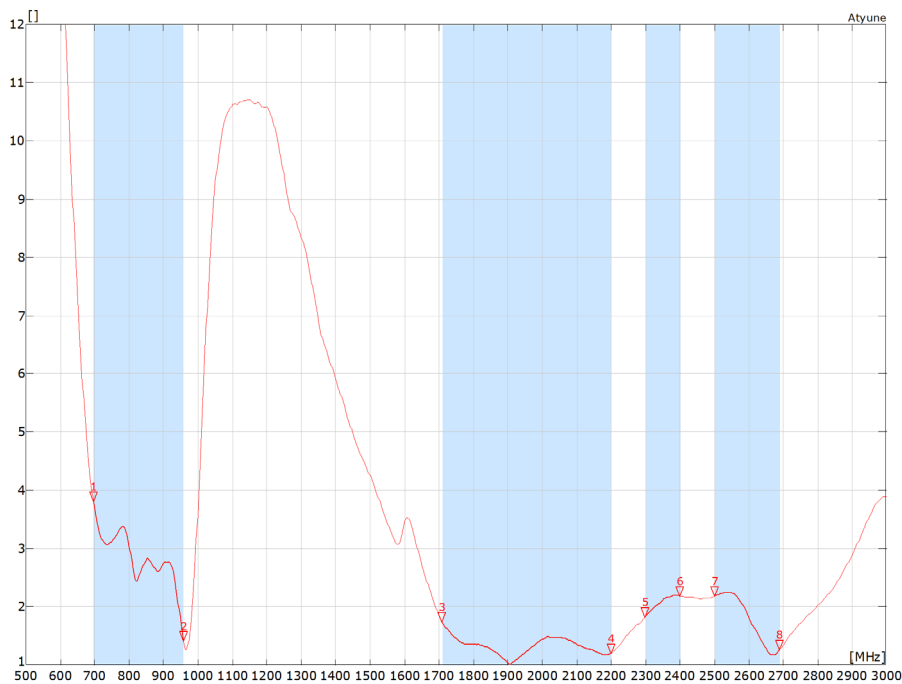

All data measured on Antenna's evaluation PCB Part No. SR4L073-EVB-1 (EVK size 60mm x 40mm)

### 6.3. Efficiency

The data was measured based on 3 different sizes of EVBs(Eval Boards): (50x40mm, 60x40mm, 90x40mm)

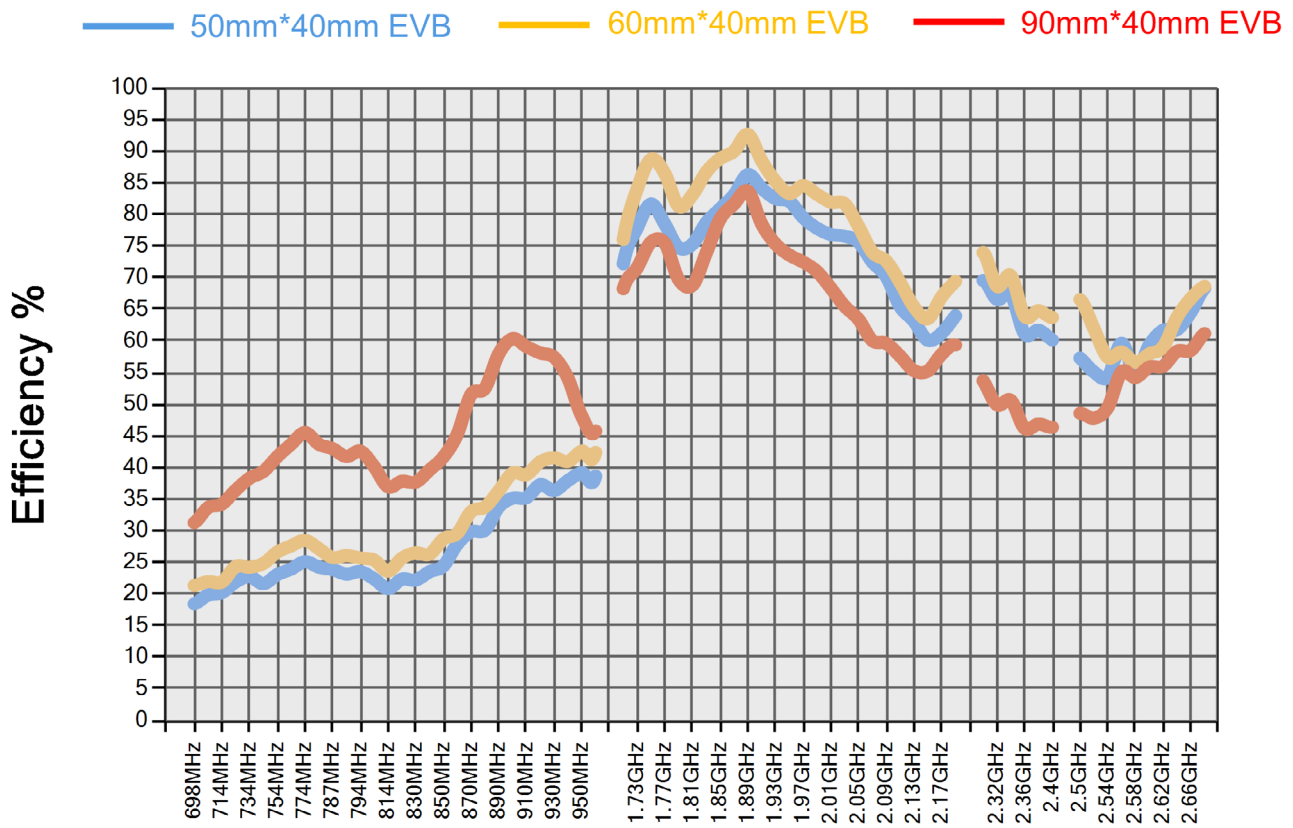

## 6.4. Antenna pattern

### 6.4.1. 698 MHz – 824 MHz

3D pattern at 764MHz

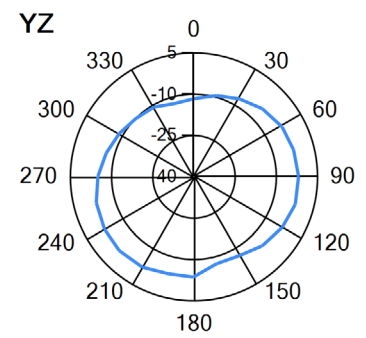
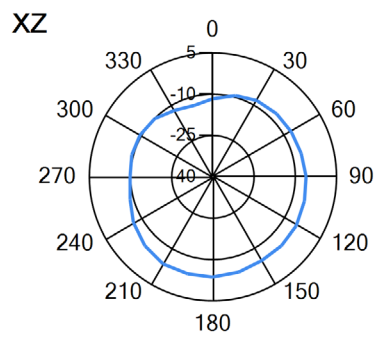
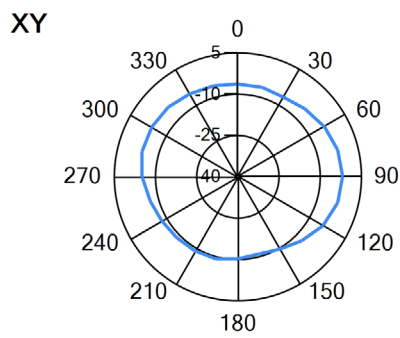
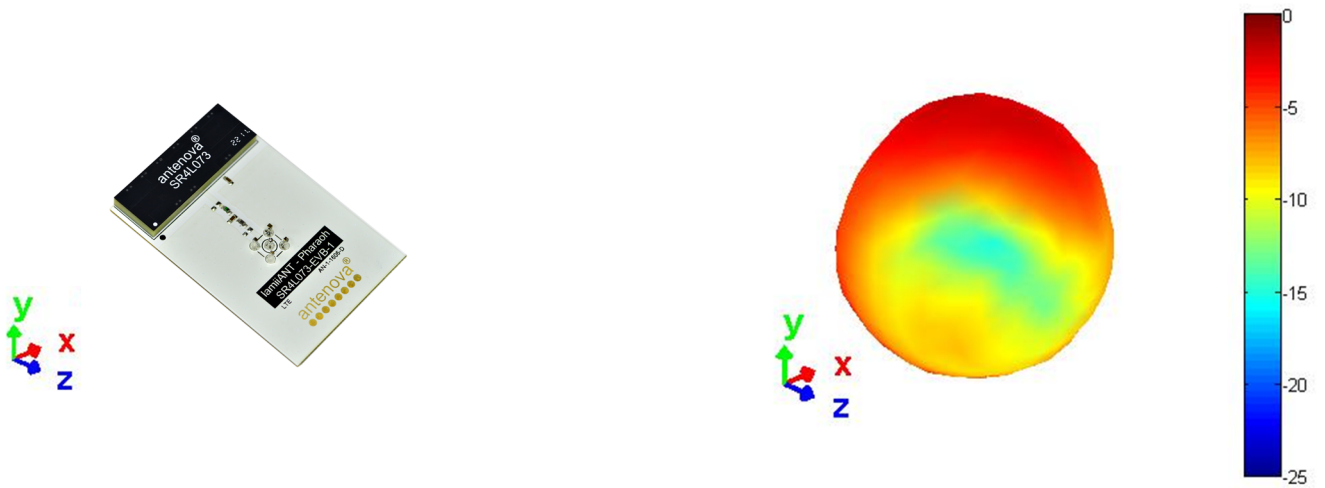

— 764MHz

6.4.2. 824 MHz – 960 MHz

3D pattern at 900MHz

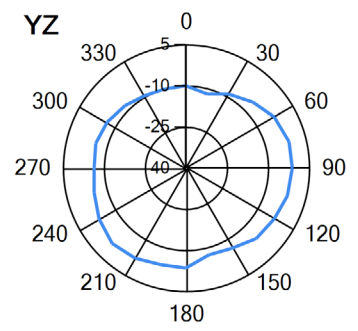
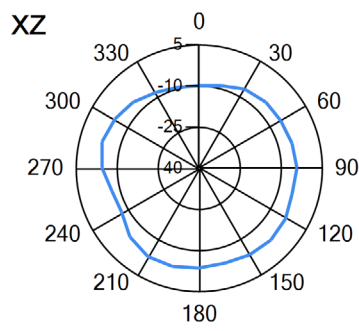
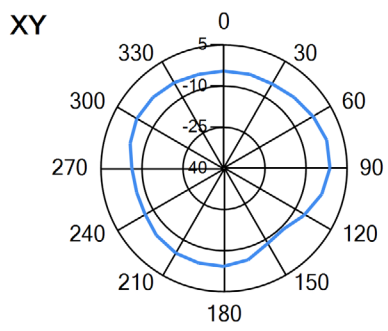
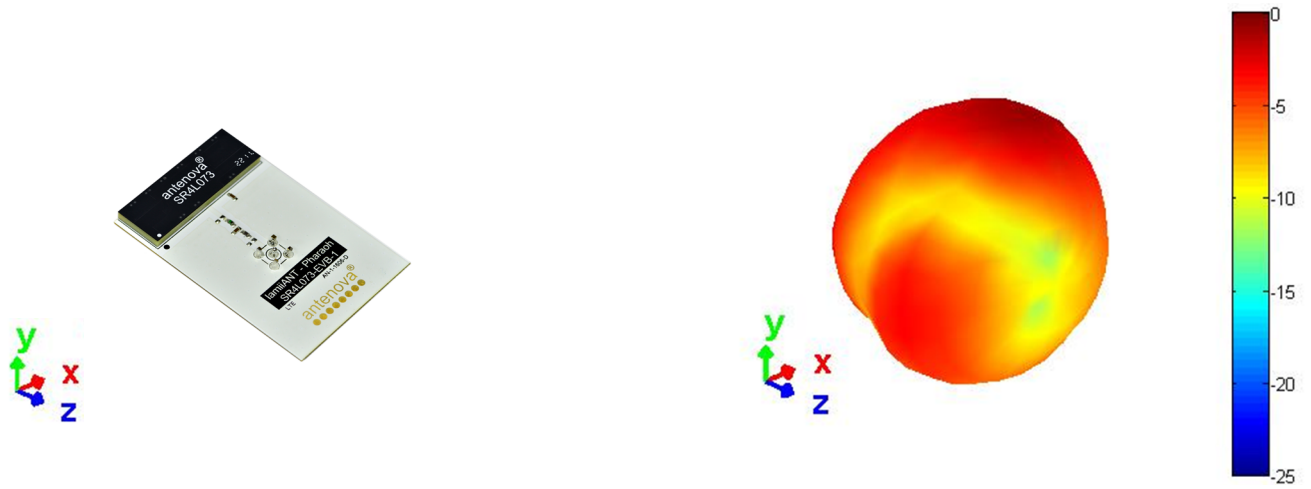

— 900MHz



6.4.3. 1710 MHz – 2200 MHz

3D pattern at 1930MHz

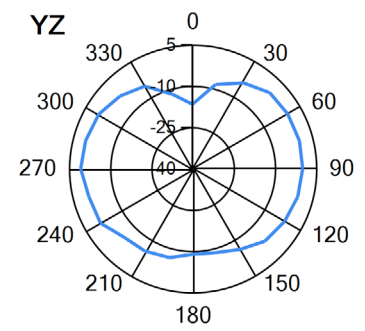
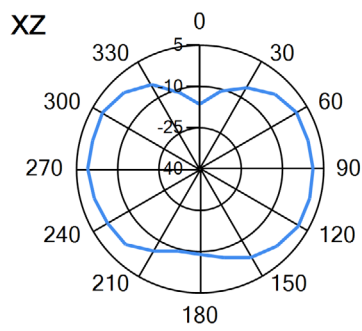
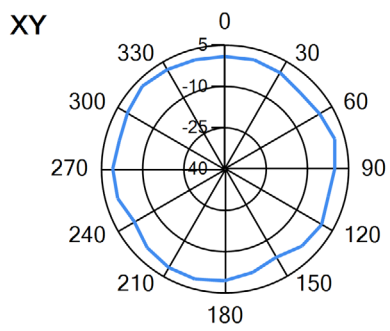
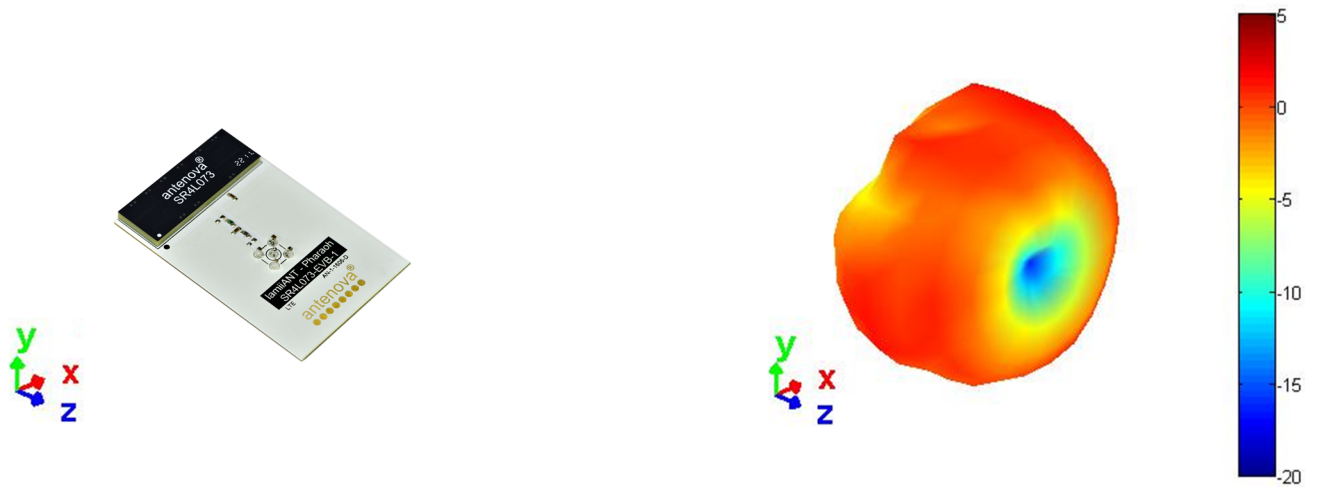

— 1.93GHz

6.4.4. 2300 MHz – 2400 MHz

3D pattern at 2340MHz

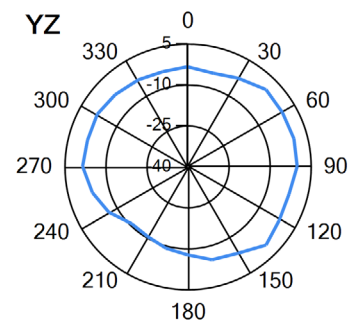
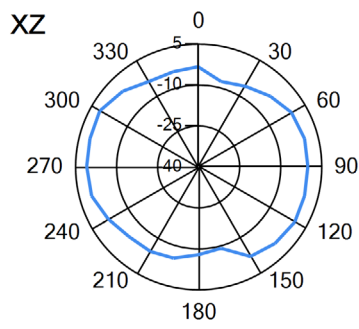
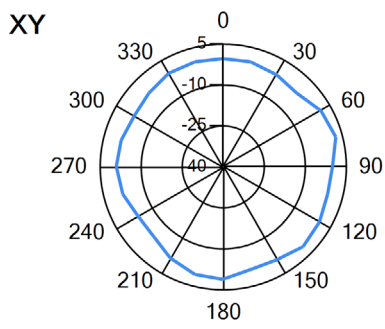
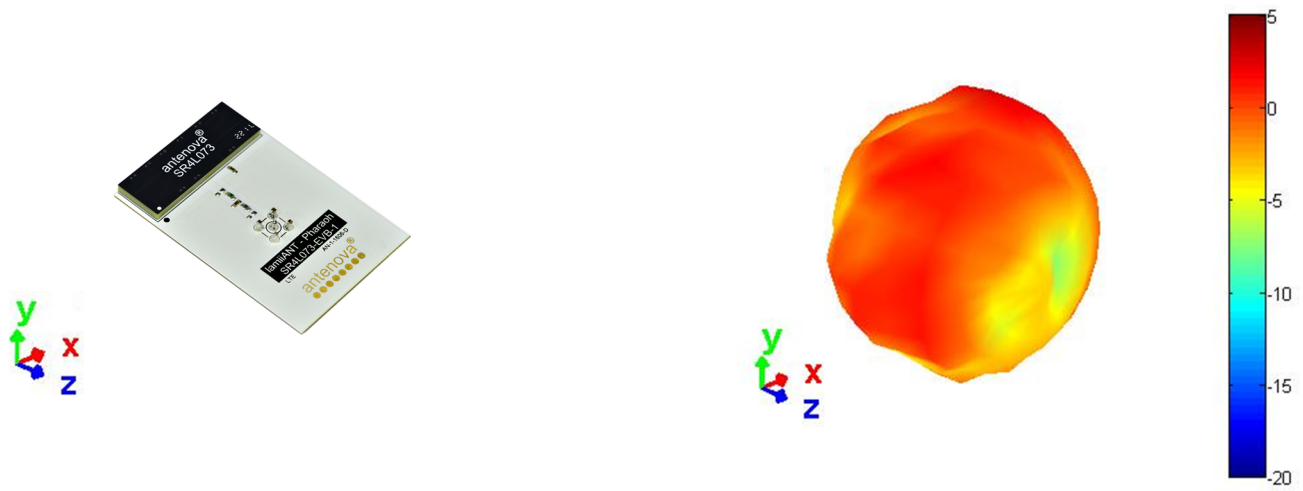

— 2.34GHz

6.4.5. 2500 MHz – 2690 MHz

3D pattern at 2600MHz

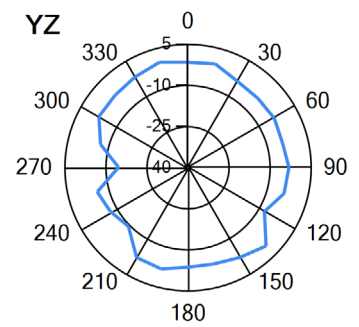
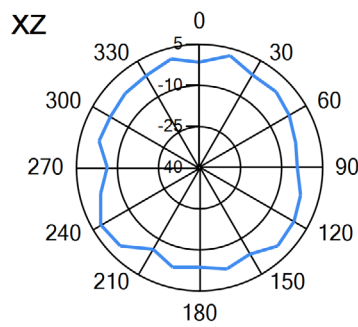
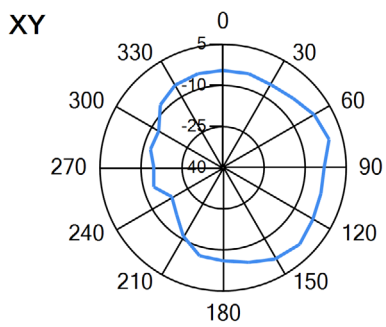
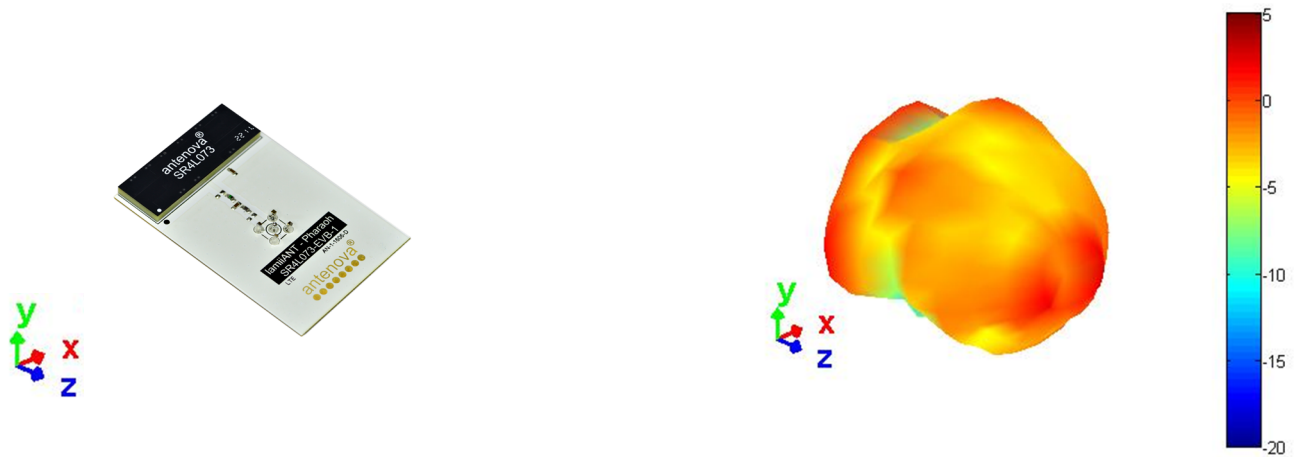

— 2.6GHz

## 7. Antenna dimensions

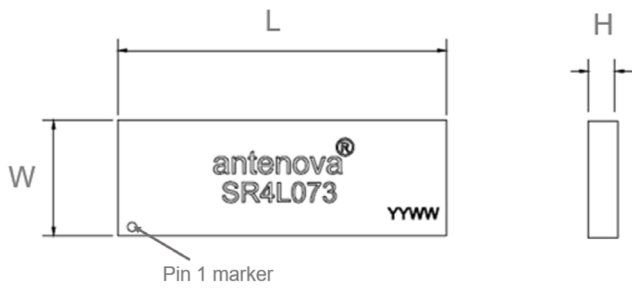

Top view

L	W	H
Length	Width	Height
37.0 ±0.1	13.0 ±0.1	3.3 ±0.1

All dimensions in (mm)

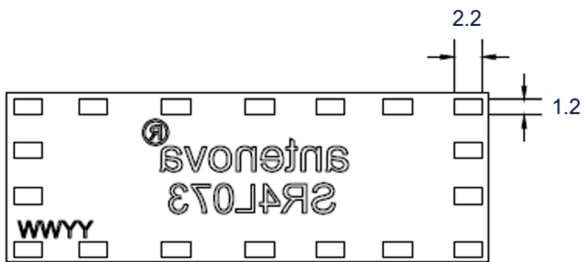

Bottom view

## 8. Schematic symbol and pin definition

The circuit symbol for the antenna is shown below. The antenna has 18 pins with only 2 as functional. All other pins are for mechanical strength.

PIN	DESCRIPTION
4	Feed (Transceiver port)
5	Return/GND
1, 2, 3, 6, 7, 8, 9, 10, 11, 12, 13, 14, 15, 16, 17, 18	NC (Not used, mechanical only)



## 9. Host PCB footprint

The recommended host PCB footprint is below.

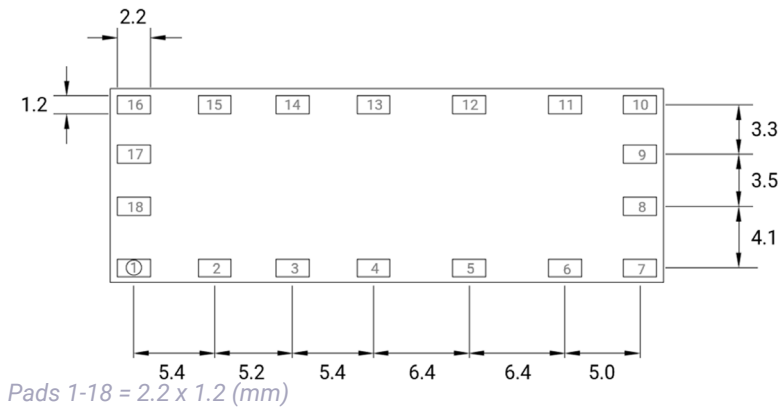

## 10. Electrical interface

### 10.1. Transmission line

All transmission lines should be designed to have a characteristic impedance of 50Ω.

- The length of each transmission lines should be kept to a minimum
- All other parts of the RF system like transceivers, power amplifiers, etc, should also be designed to have a 50 Ω impedance

A co-planar transmission line can be designed using an online transmission line calculator tool, such as:

<https://blog.antenova.com/rf-transmission-line-calculator>

The PCB thickness, copper thickness and substrate dielectric constant are entered, then the tool calculates the transmission line width and gaps on either side of the track to give a 50 Ω impedance.

### 10.2. Matching circuit

The antenna requires a matching circuit that must be optimized for each product. The matching circuit will require up to six components and the following circuit should be designed into the host PCB. Not all components may be required but should be included as a precaution. The matching network should be placed close to the antenna feed to ensure it is optionally effective in tuning the antenna.

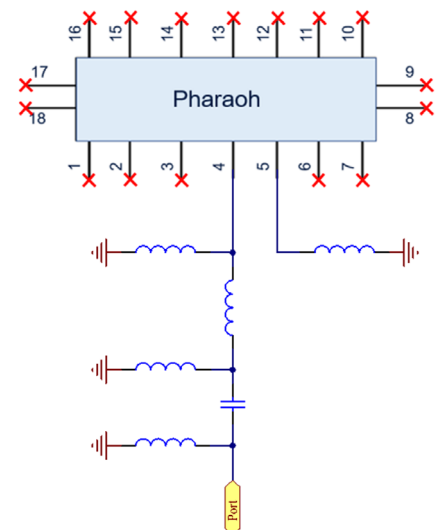

## 11. Antenna integration guide

We recommend the following during the design phase to maximise antenna performance and minimize noise:

- Minimum 4 layer PCB
- Route signals and power internally where possible
- Flood all layers with ground
- Knit ground on all layers together with plenty of vias

Follow placement guidance carefully. Antenova provide technical support to help you with your design, and also provide design assistance on PTCRB certification. Register for an account on <https://ask.antenova.com/> to access technical support.

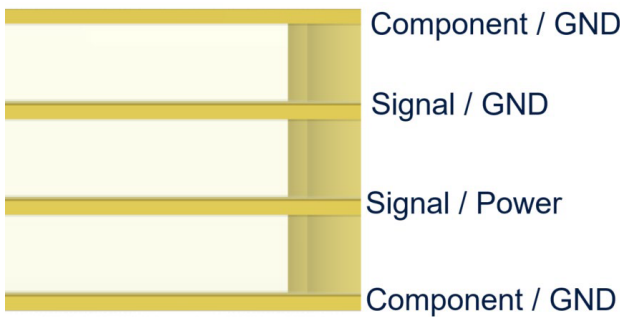

### 11.1. Antenna placement

The best position for the antenna is in the corner of the short side of the PCB. This allows the longer side of the PCB to be a ground plane, a long ground plane improves the antenna's efficiency. The antenna requires clearance ideally in 5 spatial directions as shown below. Where this cannot be achieved you should keep as many clear as possible to a minimum of 3. Please note performance will degrade with fewer clearances.

The Antenova placement tool can be used to advise on antenna placement, see: <https://blog.antenova.com/intelligent-antenna-selection-and-placement-tool-antenova>

Correct

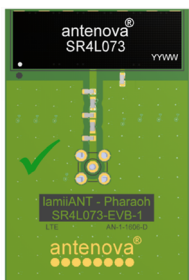

Incorrect

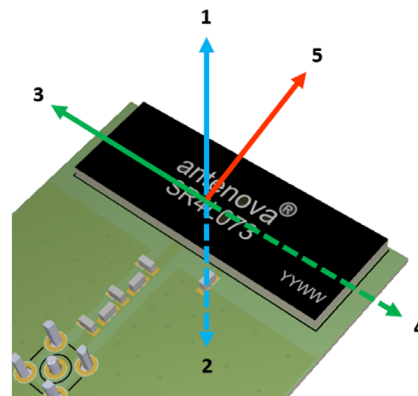
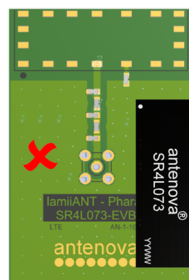

### 11.2. Host PCB layout

The host PCB must be designed using the PCB footprint shown with the correct clearances. An example of the PCB layout shows the antenna footprint. Please note this clearance area is critical to the performance of the antenna and must be applied through all layers of the PCB.

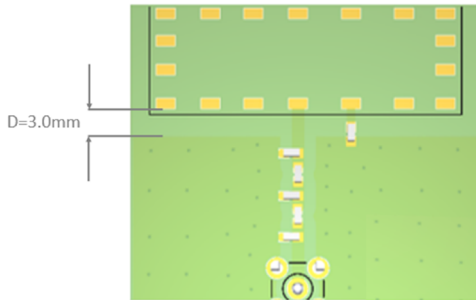

All dimensions in (mm)

### 11.3. Host PCB clearance

The diagram below shows the antenna footprint and clearance through all layers on the PCB. Only the antenna pads and connections to feed and GND are present within this clearance area.

Placement of components and GND with traces adjacent to the antenna should maintain a minimum clearance of 10mm from either side. The antenna should therefore be placed in the corner to only have one side affected.

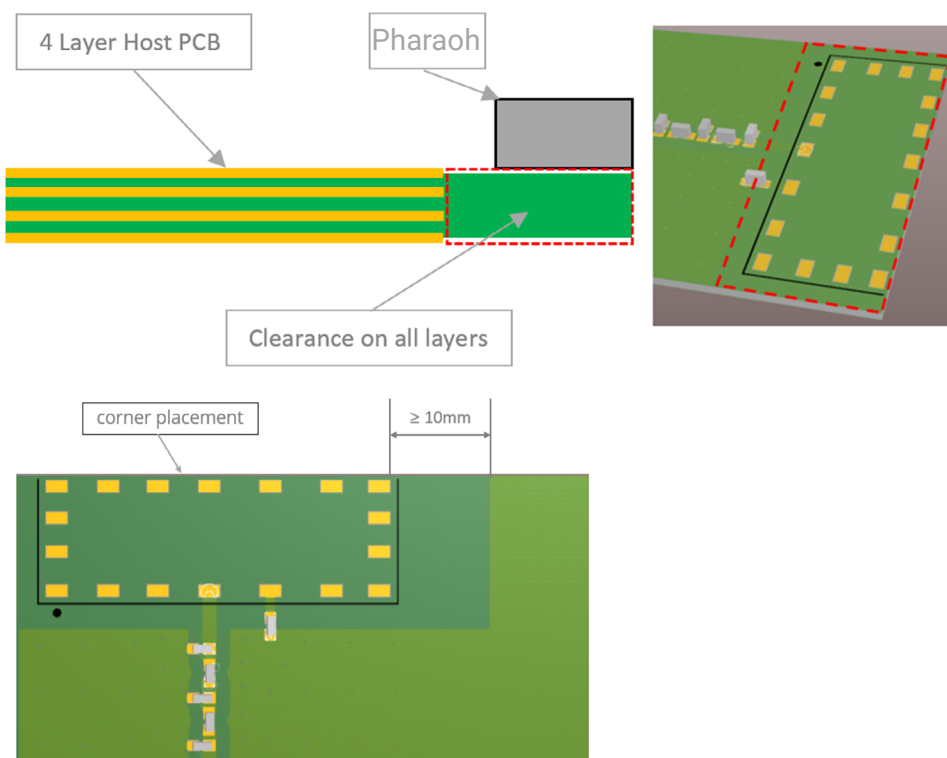



## 12. Reference board

A reference board is used for evaluating the antenna SR4L073 and it includes a SMA female connector. (Part number: SR4L073-EVB-1)

To order a reference board please see [antenova.com](http://antenova.com)

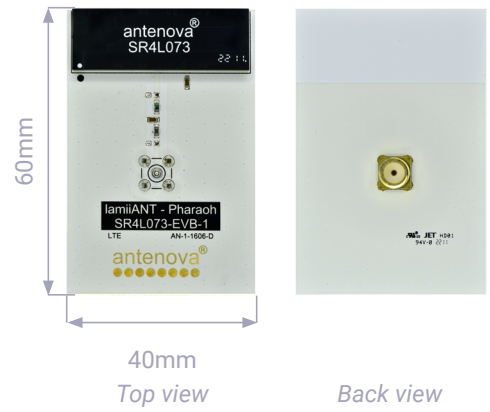

### 12.1. Reference board matching circuit

DESIGNATOR	TYPE	VALUE	DESCRIPTION
L1	NA	DNP	Not Fitted
L2	Inductor	1.2nH	Murata LQG18HN series
L3	Inductor	12nH	Murata LQG18HN series
L4	NA	DNP	Not Fitted
L5	Inductor	12nH	Murata LQG18HN series
C1	Capacitor	2.7pF	Murata GRM188 series

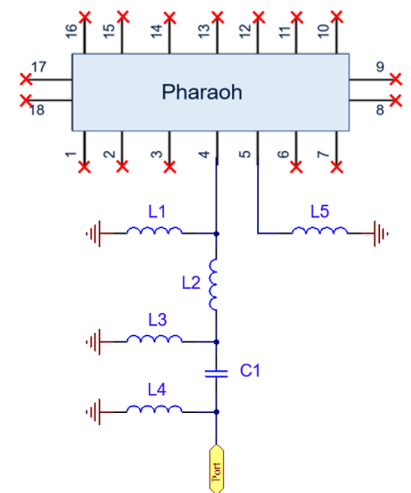

## 13. Soldering

---

This antenna is suitable for lead free soldering. The reflow profile should be adjusted to suit the device, oven and solder paste, while observing the following conditions:

- For leaded soldering, the maximum temperature should not exceed 240 °C.
- For lead free soldering, a maximum temperature of 255 °C for no more than 20 seconds is permitted.
- The antenna should not be exposed to temperatures exceeding 120 °C more than 3 times during the soldering process.

## 14. Hazardous material regulation conformance

---

The antenna has been tested to conform to RoHS and REACH requirements. A certificate of conformance is available from Antenova's website.

## 15. Packaging

---

### 15.1. Optimal storage conditions

---

TEMPERATURE	-10°C to 40°C
HUMIDITY	Less than 75% RH
SHELF LIFE	24 Months
STORAGE PLACE	Away from corrosive gas and direct sunlight
PACKAGING	Reels should be stored in unopened sealed manufacturer's plastic packaging.
MSL LEVEL	1

Note: Storage of open reels of antennas is not recommended due to possible oxidization of pads on antennas. If short term storage is necessary, then it is highly recommended that the bag containing the antenna reel is re-sealed and stored in conditions as described in the table above.

The shelf life of the antenna is 2 years provided the factory seal on the package has not been broken.

15.2. Tape characteristics

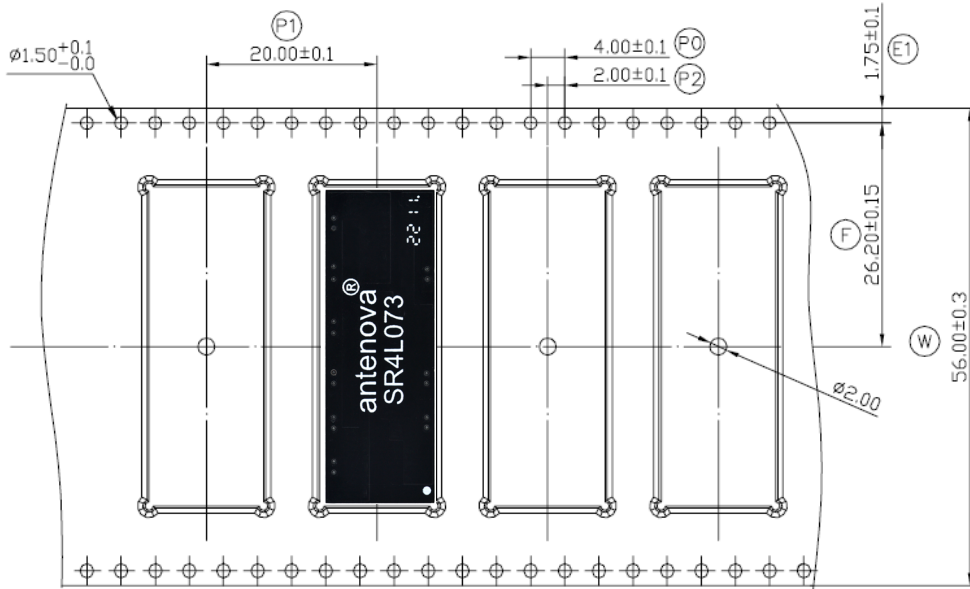

P0	P1	P2	D0
4.00 ± 0.1	20.00 ± 0.1	2.00 ± 0.1	1.50 ± 0.1

E	F	W
1.75 ± 0.1	26.20 ± 0.15	56.00 ± 0.3

All dimensions in (mm)

QUANTITY	LEADING SPACE	TRAILING SPACE
750 pcs / reel	25 blank antenna holders	25 blank antenna holders

15.3. Reel dimensions

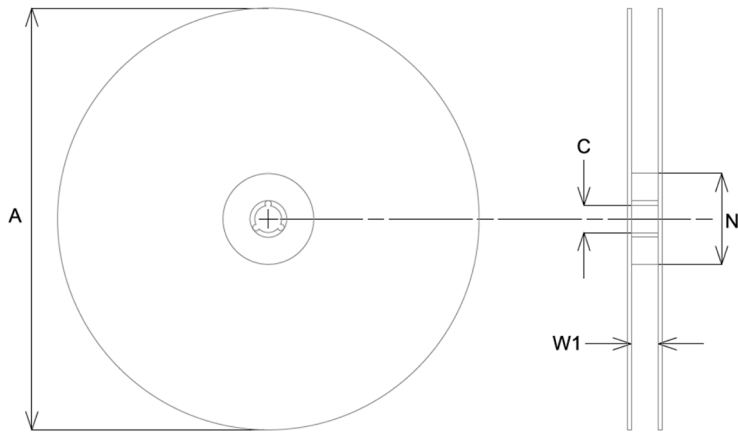

A	C	N	W1
330.0 ± 2.0	13.0 ± 0.5	100.0 ± 0.5	56 ± 0.3

All dimensions in (mm)

15.4. Box dimensions

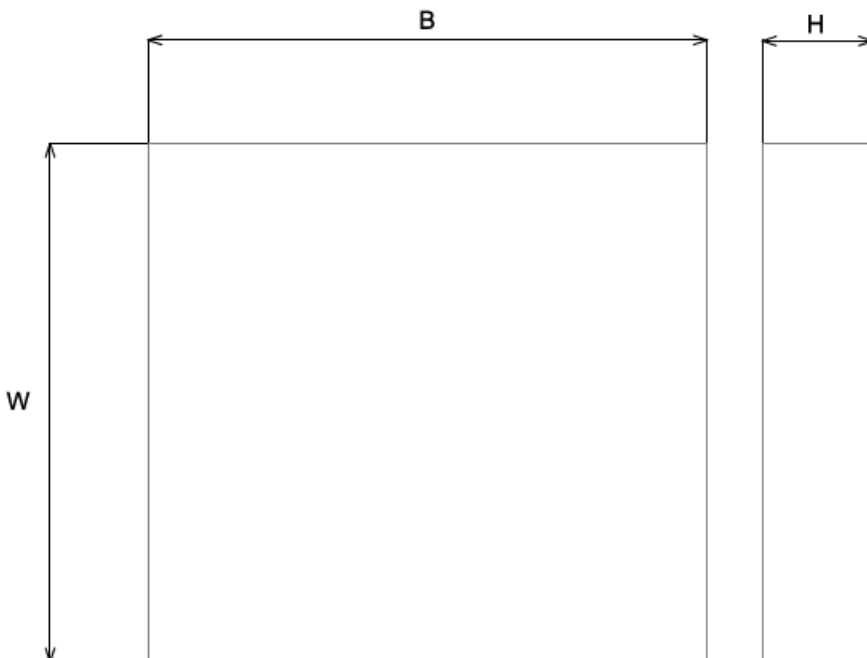

WIDTH (W)	BREADTH (B)	HEIGHT (H)
350mm	355mm	70mm

15.5. Bag properties

---

Reels are supplied in protective plastic packaging.

15.6. Reel label information

---



Quality statements

Antenova’s products conform to REACH and RoHS legislation. For our statements regarding these and other quality standards, please see antenova.com.



Antenova reserves all rights to the contents of this document. Antenova gives no warranties based solely on the accuracy or completeness of the contents of this document and reserves the right to make changes to the specifications of the products described herein at any time and without notice.

Datasheet version

1.01 released Apr 05th 2022

1.02 released May 22nd 2022

# Antenna design, integration and test resources

Product designers – the details contained in this datasheet will help you to complete your embedded antenna design. Please follow our technical advice carefully to obtain optimum antenna performance.

We aim to support our customers to create high performance wireless products. You will find a wealth of design resources, calculators and case studies to aid your design on our website.

Antenova's design laboratories are equipped with the latest antenna design tools and test chambers. We provide antenna design, test and technical integration services to help you complete your design and obtain the required certifications.

If you cannot find the antenna you require in our product range, please contact us to discuss creating a custom antenna to meet your exact requirements.

Share knowledge with **RF experts** around the world.

**ask.antenova** is a global forum for designers and engineers working with wireless technology.

[VISIT ASK.ANTENOVA](https://www.ask.antenova.com)

Visit [antenova.com](https://www.antenova.com)

Order antenna samples and evaluation boards, and read our antenna resources

[VISIT ANTENOVA.COM](https://www.antenova.com)

Request a volume quotation for antennas:

[sales@antenova.com](mailto:sales@antenova.com)

Global headquarters

**Antenova Ltd, 2nd Floor Titan Court, 3 Bishop Square, Hatfield, AL10 9NA**

**+44 (0) 1707 927589**