

REVISIONS					
REV	ECO	DESCRIPTION	DATE	BY	APPR
A1	--	RELEASED	16MAR2020	J. HEAD	DH

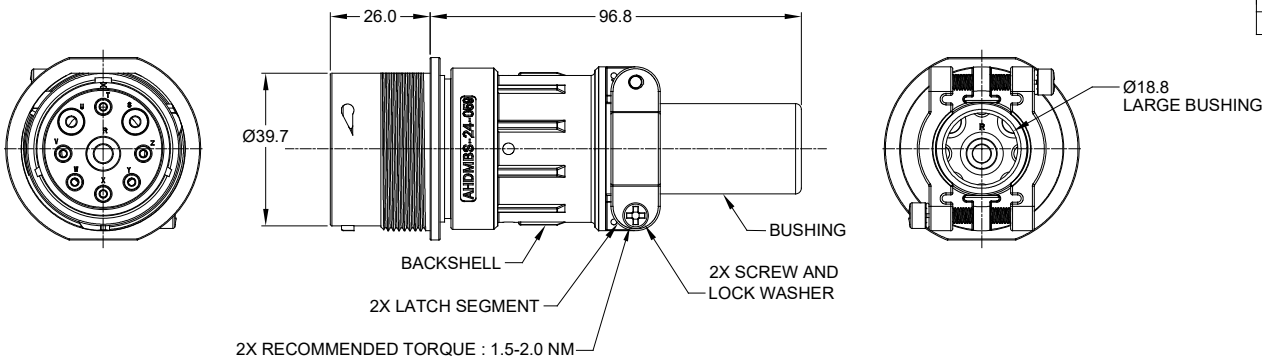

NOTES: UNLESS OTHERWISE SPECIFIED

- 1. RECEPTACLE MATERIAL:  
SHELL: ZINC ALLOY, NICKEL PLATED  
INSERT AND RETAINING RING: THERMOPLASTIC  
SEAL: SILICONE RUBBER
- 2. BACKSHELL MATERIAL:  
SHELL: ALUMINIUM ALLOY, NICKEL PLATED;  
LATCH SEGMENT: ALUMINIUM ALLOY, NICKEL PLATED;  
SCREW AND LOCK WASHER: STAINLESS STEEL;  
BUSHING: EPDM.
- 3. SPECIFICATIONS:  
3.1 OPERATING TEMPERATURE: -55°C TO +125°C.  
3.2 DIELECTRIC WITHSTANDING VOLTAGE: LESS THAN 2 MILLIAMPS CURRENT LEAKAGE @ 1500 VOLTS AC.  
3.3 INSULATION RESISTANCE: 1000 MEGOHM MIN @ 25°C.  
3.4 MOISTURE RESISTANCE: IP67 & IP69K (MATED CONDITION).  
3.5 MATING CYCLE DURABILITY: 100 CYCLES  
3.6 RoHS COMPLIANT
- 4. APPLY TO CABLE OD SIZE: Ø11.20-Ø24.08 . CAN BE USED:  
4.1. WITH LARGE AND SMALL BUSHINGS IN PLACE.  
4.2. WITH ONLY LARGE BUSHING IN PLACE.  
4.3. WITH BOTH BUSHINGS REMOVED.
- 5. ALL DIMENSIONS ARE FOR REFERENCE USE ONLY.
- 6. SEE SPECIFIC RECEPTACLE DRAWING FOR:  
6.1 CONTACT SIZE AND WIRE RANGE.  
6.2 RETAINING RING COLOR.  
6.3 MATING PART(S).  
6.4 CONTACT LAYOUT AND ALL OTHER SPECIFICATIONS.

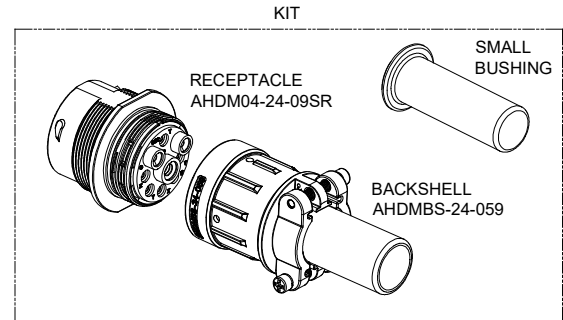
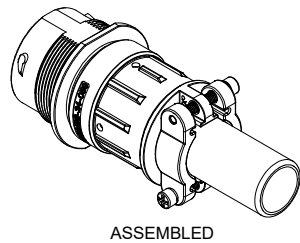

AHDMS-24-059		HDM-24-09SR-059	
QUANTITY	PART NUMBER	DESCRIPTION	
		ITEM	
<b>MATERIALS LIST</b>			
UNLESS OTHERWISE SPECIFIED 1) All dimensions are in metric (mm). 2) Tolerances are as follows: 1 PL DEC ±0.30 2 PL DEC ±0.15 3 PL DEC ±0.08 Fractions ±1/64 Angles ±1° 3) Note reference =		SIGNATURES      DATE DRAWN: J. HEAD      16MAR2020 CHECKED: ENGINEER: APPROVAL:	
MATERIAL SPECIFICATIONS:		CUSTOMER:	
PROCESS SPECIFICATIONS:		THIS DRAWING IS SUPPLIED FOR INFORMATION ONLY. DESIGN FEATURES, SPECIFICATIONS AND PERFORMANCE DATA SHOWN HEREON ARE THE PROPERTY OF THE AMPHENOL CORPORATION. NO RIGHTS OF REPRODUCTION ARE IMPLIED. ALL DIMENSIONS ARE SUBJECT TO NORMAL MANUFACTURING VARIATIONS.	
NEXT ASSY:	SIZE: B C-	TYPE: AHDMS-24-059	REVISION: A1
SCALE: NONE		SHEET 1 OF 1	

TITLE: KIT RECEPT AND BACKSHELL SZ 24  
DWG NO: AHDMS-24-09SR-059  
REV: A1  
SH: 1  
OF: 1

# MagnaMate™ ATHP - DuraMate™ AHDP - DuraMate™ AHDM Series - Contact Size 12 Options

Machined Contacts, Sockets & Pins				
Part Number	Description	Size	AWG	Type
AT60-204-12141-10	Male Contact - Pin, Nickel-plated	12	10-12	Machined
AT62-203-12141-10	Female Contact - Socket, Nickel-plated	12	10-12	Machined
AT60-220-1231	Male Contact - Pin, Gold-plated	12	12-14	Machined
AT62-210-1231	Female Contact - Socket, Gold-plated	12	12-14	Machined
AT60-204-12141	Male Contact - Pin, Nickel-plated	12	12-14	Machined
AT62-203-12141	Female Contact - Socket, Nickel-plated	12	12-14	Machined

DiagnosticGrade™ Machined Contacts, Sockets & Pins				
• Smaller AWG for Diagnostic Applications • Gold-plated • Increased Mating Cycles • Cost-effective				
Part Number	Description	Size	AWG	Type
65-54749	Male Contact - DiagnosticGrade™, Pin, Gold-plated	12	20	Machined
AT62-210-1231-1820	Female Contact - DiagnosticGrade™, Socket, Gold-plated	12	20	Machined

Tooling - Machined Contacts		
Part	Part Number	Description
	CA-5D12	Universal Hand Crimp Tool, Size 12/16/20 (Machined contacts only)
	CA-5E12	Pneumatic Crimp Tool, Size 12/16/20 (Machined contacts only)

Contact Removal Tools		
Part	Part Number	Description
	AT11-337-1205	Contact Removal Tool, Plastic, Size 12
	A114017	Sealing Plug, Size 12, White





Stamped & Formed Contacts, Sockets & Pins				
Part Number	Description	Size	AWG	Type
AT60-12-0244	Male Contact - Pin, Gold-plated	12	10-12	Stamped & Formed
AT62-12-0244	Female Contact - Socket, Gold-plated	12	10-12	Stamped & Formed
AT60-12-0222	Male Contact - Pin, Nickel-plated	12	10-12	Stamped & Formed
AT62-12-0222	Female Contact - Socket, Nickel-plated	12	10-12	Stamped & Formed
AT60-12-0144	Male Contact - Pin, Gold-plated	12	12-14	Stamped & Formed
AT62-12-0144	Female Contact - Socket, Gold-plated	12	12-14	Stamped & Formed
AT60-12-0166	Male Contact - Pin, Nickel-plated	12	12-14	Stamped & Formed
AT62-12-0166	Female Contact - Socket, Nickel-plated	12	12-14	Stamped & Formed

Tooling - Stamped & Formed Contacts		
Part	Part Number	Description
	MXF-3973	Crimp Die - Size 12 (S&F contacts only)
	MXF-3985	Crimp Die - Size 12 (S&F contacts only) 10-12AWG -02XX Series
	ATT-12-00	Hand Crimp Tool - Size 12, 12AWG (S&F contacts only)
	ATT-12-01	Hand Crimp Tool - Size 12, 10AWG (S&F contacts only)

**Amphenol Sine Systems**  
 44724 Morley Drive  
 Clinton Township, MI 48036 USA  
[www.amphenol-sine.com](http://www.amphenol-sine.com)  
 01/2022

# DuraMate™ ATHD Series™ - Contact Size 8 Options





Machined Contacts, Pins and Sockets					
Part Number	Description	Size	AWG	Type	Amps
AT60-204-08141	Male Contact - Pin, Copper Alloy, Nickel-Plated	8	8-10	Machined	60A
AT62-203-08141	Female Contact - Socket, Copper Alloy, Nickel-Plated	8	8-10	Machined	60A

Tooling - Machined Contacts		
Part	Part Number	Description
	WA23	Heavy Duty Pneumatic Crimp Tool -Uses Universal Positioner Part No. WA23-101DA and Crimp Locator MFX-3961
	WA23-2	Die Assembly -for CA-5E12 Heavy Duty Pneumatic Crimp Tool, Size 8
	WA23-10	Contact Locator, Size 8
	96-978-22	Crimper and Dies -for Size 10mm <sup>2</sup> -185mm <sup>2</sup> Wires

Contact Removal Tools		
Part	Part Number	Description
	AT114008	Contact Removal Tool, Plastic, Size 8, 8-10AWG

## DuraMate™ ATHD Series™ - Contact Size 4 Options

Machined Contacts, Pins and Sockets					
Part Number	Description	Size	AWG	Type	Amps
AT60-203-04141-4	Male Contact - Pin, Copper Alloy, Nickel-Plated	4	4	Machined	100A
AT60-204-0490	Male Contact - Pin, Copper Alloy, Nickel-Plated	4	6	Machined	100A
AT62-203-04141-4	Female Contact - Socket, Copper Alloy, Nickel-Plated	4	4	Machined	100A
AT62-203-04141	Female Contact - Socket, Copper Alloy, Nickel-Plated	4	6	Machined	100A

Tooling - Machined Contacts		
Part	Part Number	Description
	WA23	Heavy Duty Pneumatic Crimp Tool -Uses Universal Positioner Part No. WA23-101DA and Crimp Locator MFX-3961
	WA23-138DA	Die Assembly -for Heavy Duty Pneumatic Crimp Tool, Size 4
	WA23-11	Contact Locator, Size 4
	96-978-22	Crimper and Dies -for Size 10mm <sup>2</sup> -185mm <sup>2</sup> Wires

Contact Removal Tools		
Part	Part Number	Description
	AT11-027-0405	Contact Removal Tool, Plastic, Size 4, 4AWG