

● Features:

- * Non-contact switching.
- * For direct pc board or dual-in-line socket mounting.
- * Fast switching speed.
- * This product doesn't contain restriction substance, comply RoHS standard

● Package Dimensions

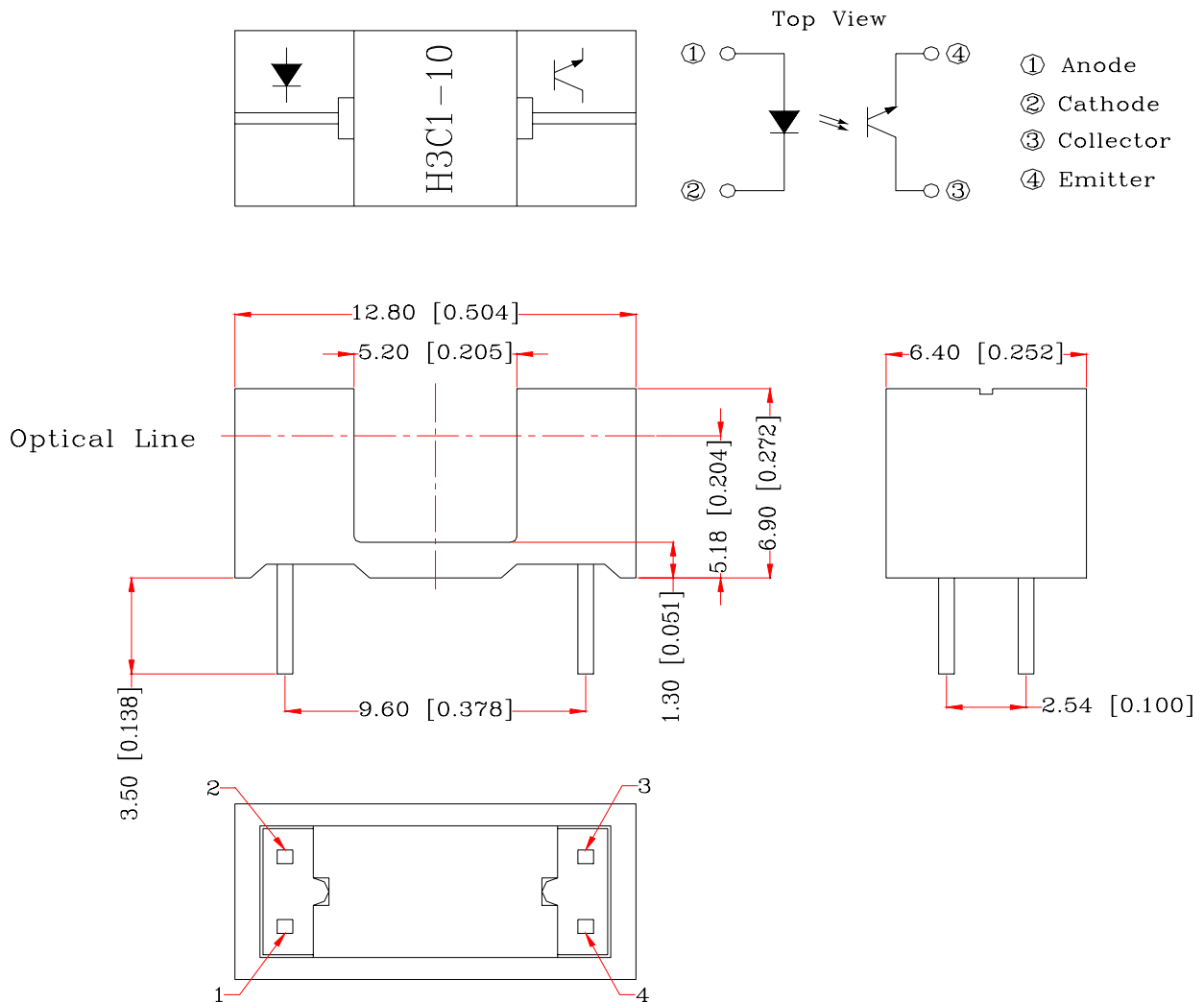

Notes:

1. All dimensions are in millimeters(inches).
2. Tolerance is $\pm 0.25\text{mm}$ unless otherwise specified.
3. Lead spacing is measured where the leads emerge from the package.
4. Specifications are subject to change without notice.



● Absolute Maximum Rating (Ta=25°C)

Item		Symbol	Rating	Unit
Input	Power Dissipation	Pd	75	mW
	Reverse Voltage	V _R	5	V
	Forward Current	I _F	50	mA
	Peak Forward Current (*1)	I _{FP}	1	A
Output	Collector Power Dissipation	P _C	100	mW
	Collector Current	I _C	40	mA
	C-E Voltage	V _{CEO}	30	V
	E-C Voltage	V _{ECO}	5	V
Operating Temperature		Topr	-40 ~ +85	°C
Storage Temperature		Tstg	-40 ~ +100	°C
Soldering Temperature (*2)		Tsol	260	°C

(*1) tw=100 uSec. 、 T=10 mSec.

(*2) t=5 Sec

● Electrical Optical Characteristics (Ta=25°C)

Parameter		Symbol	Condition	Min.	Typ.	Max.	Unit
Input	Forward Voltage	V _F	I _F =20mA	—	1.2	1.5	V
	Reverse Current	I _R	V _R =5V	—	—	100	μA
	Peak Wavelength	λ _p	I _F =20mA		940		nm
Output	Dark Current	I _D	V _{CE} =10V	—	—	100	nA
	C-E Saturation Voltage	V _{CE(sat)}	I _C =0.5mA I _F =20mA	—	—	0.4	V
Light Current		I _L	V _{CE} =5V I _F =10mA	0.5	—	5	mA
Speed	Rise Time	T _r	I _{FP} =20mA V _{CE} =5V	—	15	—	μsec
	Fall Time	T _f	R _L =1000Ω	—	15	—	μsec

● Typical Electrical / Optical Characteristics Curves (Ta=2°C)

Fig.1 Power Dissipation vs. Ambient Temperature

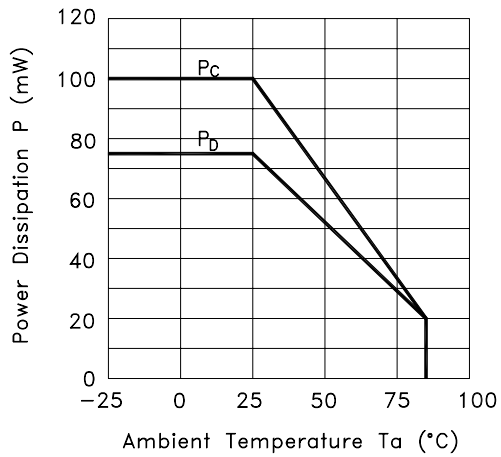

Fig.2 Forward Current vs. Forward Voltage

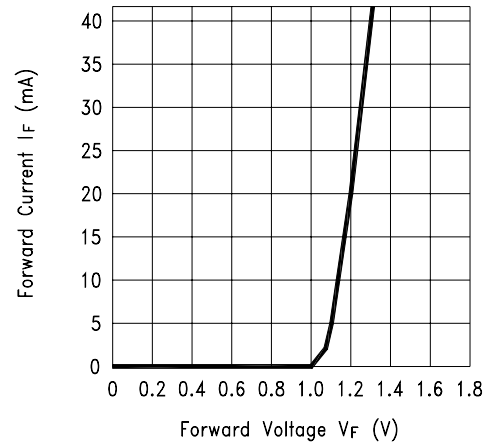

Fig.3 Collector Current vs. Collector-emitter Voltage

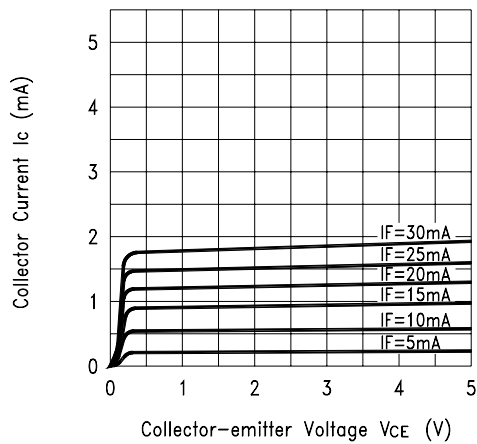
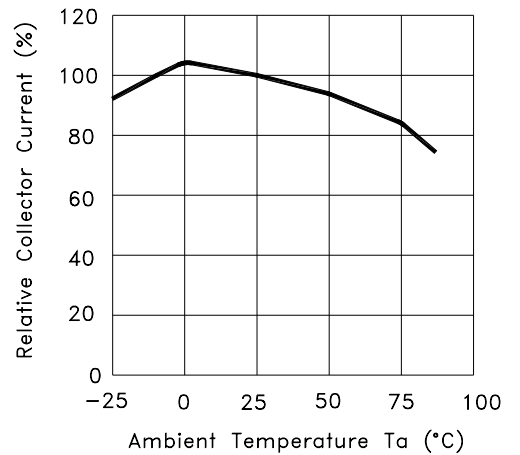

Fig.4 Collector Current vs. Ambient Temperature



● Typical Electrical / Optical Characteristics Curves (Ta=25°C)

Fig.5 Collector-emitter Saturation Voltage vs. Ambient Temperature

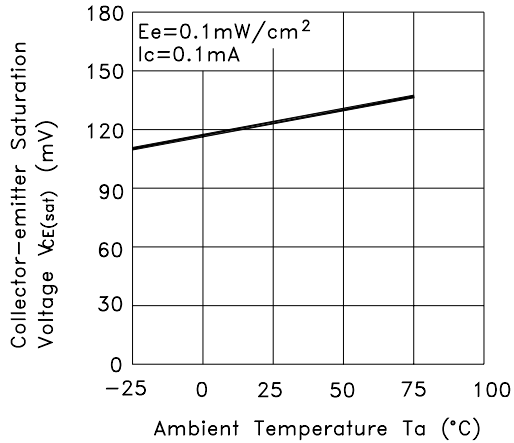

Fig.6 Response Time vs. Load Resistance

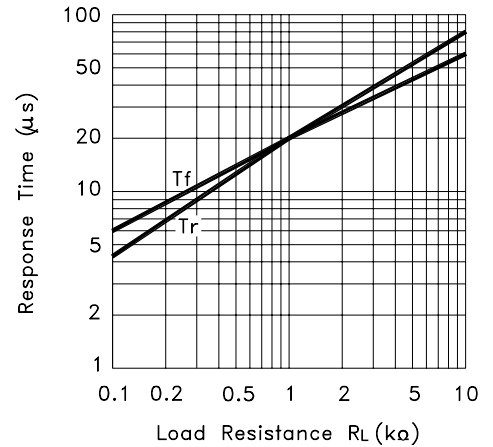
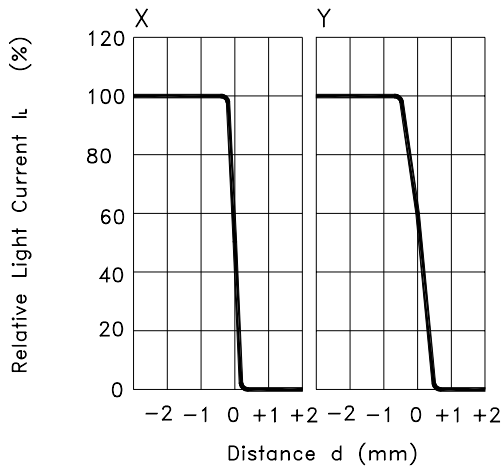
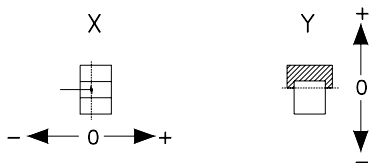

Fig.7 Sensing Position Characteristics (Typical)



(Center of Optical axis)



Test Circuit for Response Time

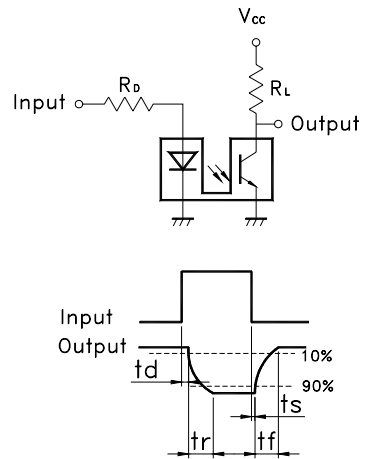

● Dip Soldering

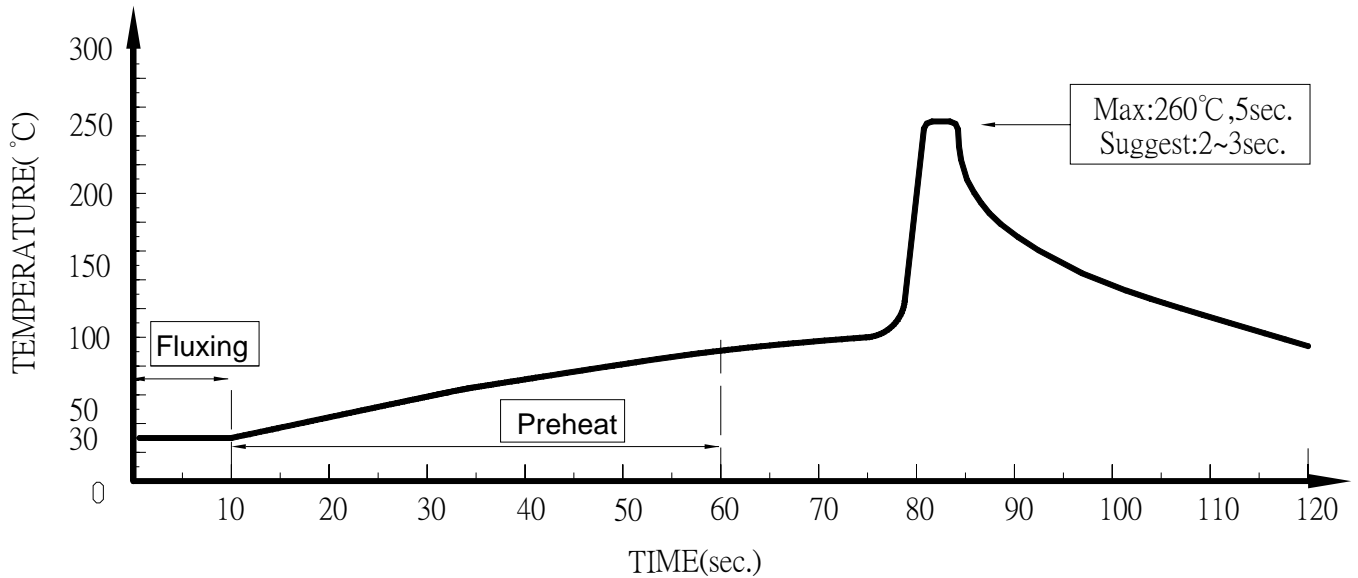

1. Please avoid any external stress applied to the lead-frames and epoxy while the LEDs are at high temperature, especially during soldering
2. DIP soldering and hand soldering should not be done more than one time.
3. After soldering, avoid the epoxy lens from mechanical shock or vibration until the LEDs are back to room temperature.
4. Avoid rapid cooling during temperature ramp-down process
5. Although the soldering condition is recommended above, soldering at the lowest possible temperature is feasible for the LEDs

● IRON Soldering

300°C Within 3 sec., One time only.

● Packaging Box Dimensions

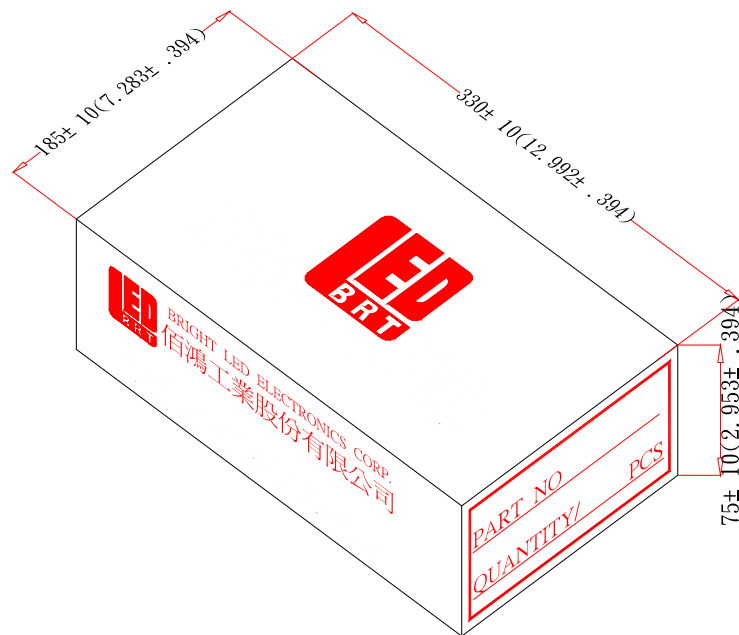

● Packaging Bag Dimensions

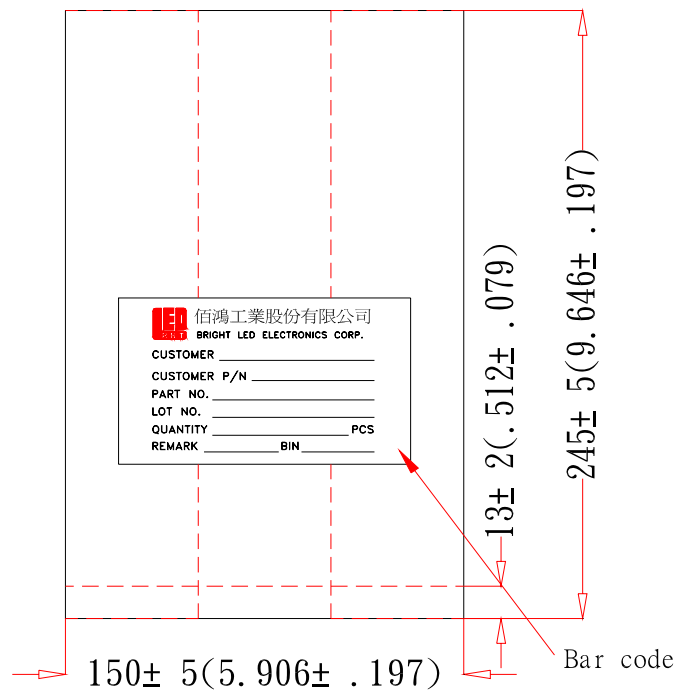

Notes:

1. 500pcs per bag, 2kpcs per box.
2. All Dimensions are in millimeters (inches).
3. Specifications are subject to change without notice.