

# SUNON Mighty Mini Fan

**-Tunnel Cushion-  
Per order placing**



**Date : 2018/10/04**

**SUNON®**

# Purpose & Description

## 1. Purpose/目的

All Mighty Mini Fan and Blower are adding tunnel cushion, in order to distinguish easier from PN and appearance.

全系列產品增加加入風閘控, 為易於從外觀辨認, 不致與庫存品混淆, 特配合經銷商供管理運用

## 2. Description/描述

Different SEQ and marking on PN behind also stick label on carton for distinguishable and warehouse managing purpose.





配合另外產出成品代號, PN 後方加註字樣並於外箱加貼標籤供識別

(因成品代號不同, 因此經銷商安排入庫時不會與之前成品代號合併為同一筆庫存)

**1:PN 後方加字樣供識別: TC (代表Tunnel Cushion)**



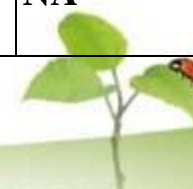

**2:外箱加貼”Tunnel Cushion” (相關位置待HQ通知)**

# Description/調整描述 – Mighty Mini Fan – Now in warehouse

Original	Size	PN	SEQ	Inc disty	version
	MMF1003 (10X10X3mm)	UF3A3-500	D01001031F-00	UF3A3-500	NA
		UF3A3-700	D01001041F-00	UF3A3-700	NA
	MMF1203 (12X12X3mm)	UF3C3-500	D01001051F-00	UF3C3-500	NA
		UF3C3-700	D01001061F-00	UF3C3-700	NA
	MMF1503 (15X15X3mm)	UF3F3-500	D01000841F-00	UF3F3-500	NA
		UF3F3-700	D01000851F-00	UF3F3-700	NA
	MMF1703 (17X17X3mm)	UF3H3-500	D01000881F-00	UF3H3-500	NA
		UF3H3-700	D01000871F-00	UF3H3-700	NA







# Description/調整描述 – Mighty Mini Blower -Now in warehouse

Original	Size	PN	SEQ	Inc disty	version
	<b>MMB0903 (9X9X3mm)</b>	<b>UB393-500</b>	<b>D0A000021F-00</b>	<b>UB393-500</b>	<b>NA</b>
		<b>UB393-700</b>	<b>D0A000031F-00</b>	<b>UB393-700</b>	<b>NA</b>
	<b>MMB1203 (12X12X3mm)</b>	<b>UB3C3-500</b>	<b>D01000921F-00</b>	<b>UB3C3-500</b>	<b>NA</b>
		<b>UB3C3-700</b>	<b>D01000911F-00</b>	<b>UB3C3-700</b>	<b>NA</b>
	<b>MMB1503 (15X15X3mm)</b>	<b>UB3F3-500</b>	<b>D01000761F-00</b>	<b>UB3F3-500</b>	<b>NA</b>
		<b>UB3F3-700</b>	<b>D01000771F-00</b>	<b>UB3F3-700</b>	<b>NA</b>
	<b>MMB1703 (17X17X3mm)</b>	<b>UB3H3-500</b>	<b>D01000941F-00</b>	<b>UB3H3-500</b>	<b>NA</b>
		<b>UB3H3-700</b>	<b>D01000931F-00</b>	<b>UB3H3-700</b>	<b>NA</b>







# Description/調整描述 – Mighty Mini Fan – For coming PO

<b>Tunnel Cushion</b>	<b>Size</b>	<b>SUNON PN</b>	<b>PN for Inc disty</b>	<b>SEQ</b>	<b>version</b>
	<b>MMF1003 (10X10X3mm)</b>	<b>UF3A3-500</b>	<b>UF3A3-500 TC</b>	<b>D01001031F-01</b>	<b>Yes</b>
		<b>UF3A3-700</b>	<b>UF3A3-700 TC</b>	<b>D01001041F-01</b>	<b>Yes</b>
	<b>MMF1203 (12X12X3mm)</b>	<b>UF3C3-500</b>	<b>UF3C3-500 TC</b>	<b>D01001051F-02</b>	<b>Yes</b>
		<b>UF3C3-700</b>	<b>UF3C3-700 TC</b>	<b>D01001061F-01</b>	<b>Yes</b>
	<b>MMF1503 (15X15X3mm)</b>	<b>UF3F3-500</b>	<b>UF3F3-500 TC</b>	<b>D01000841F-04</b>	<b>Yes</b>
		<b>UF3F3-700</b>	<b>UF3F3-700 TC</b>	<b>D01000851F-01</b>	<b>Yes</b>
	<b>MMF1703 (17X17X3mm)</b>	<b>UF3H3-500</b>	<b>UF3H3-500 TC</b>	<b>D01000881F-01</b>	<b>Yes</b>
		<b>UF3H3-700</b>	<b>UF3H3-700 TC</b>	<b>D01000871F-02</b>	<b>Yes</b>

**TC : stand for “Tunnel Cushion”**

**Particular request from customer**

# Description/調整描述 – Mighty Mini Blower – For coming PO

<b>Tunnel Cushion</b>	<b>Size</b>	<b>SUNON PN</b>	<b>PN for Inc disty</b>	<b>SEQ</b>	<b>version</b>
	<b>MMB0903 (9X9X3mm)</b>	<b>UB393-500</b>	<b>UB393-500 TC</b>	<b>D0A000021F-02</b>	<b>Yes</b>
		<b>UB393-700</b>	<b>UB393-700 TC</b>	<b>D0A000031F-02</b>	<b>Yes</b>
	<b>MMB1203 (12X12X3mm)</b>	<b>UB3C3-500</b>	<b>UB3C3-500 TC</b>	<b>D01000921F-01</b>	<b>Yes</b>
		<b>UB3C3-700</b>	<b>UB3C3-700 TC</b>	<b>D01000911F-01</b>	<b>Yes</b>
	<b>MMB1503 (15X15X3mm)</b>	<b>UB3F3-500</b>	<b>UB3F3-500 TC</b>	<b>D01000761F-01</b>	<b>Yes</b>
		<b>UB3F3-700</b>	<b>UB3F3-700 TC</b>	<b>D01000771F-01</b>	<b>Yes</b>
	<b>MMB1703 (17X17X3mm)</b>	<b>UB3H3-500</b>	<b>UB3H3-500 TC</b>	<b>D01000941F-01</b>	<b>Yes</b>
		<b>UB3H3-700</b>	<b>UB3H3-700 TC</b>	<b>D01000931F-02</b>	<b>Yes</b>

**TC : stand for “Tunnel Cushion”**

**Particular request from customer**

# Description on Data Sheet – Cover Page

For example :

**CUSTOMER** : **Sunon Inc.**

**MOTOR TYPE** : 

**DESCRIPTION** : **MagLev Motor Fan**

**DIMENSIONS** : **10X10X3 mm**

**M O D E L** : **UF3A3-500**

**SUNON SPEC. NO.** : **D01001031F-01**

**CUSTOMER APPROVAL NO.** : **UF3A3-500 TC**

**APPROVED BY** :  
**CUSTOMER** :  
(AUTHORIZED)



**SUNON.**

# Description on Data Sheet - Unit

For example :

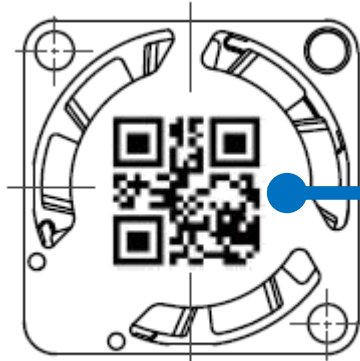

QR Code



UF3A3-500 TC

Marking (By laser):

SUNON

UF3A3-500 TC:Model name

Production serial number:0Y17xxxxxx

0:Printing Plant Code

Y:Manufacture Plant

17:Year,2017=17

xxxxxx: Producing Lot No.

QR code :Content according to

SUNON QR code specification

TC:CUSTOMER NUMBER

UF3A3-500 TC

TC : CUSTOMER NUMBER



**SUNON.**



# Label on Carton for identify

For example :

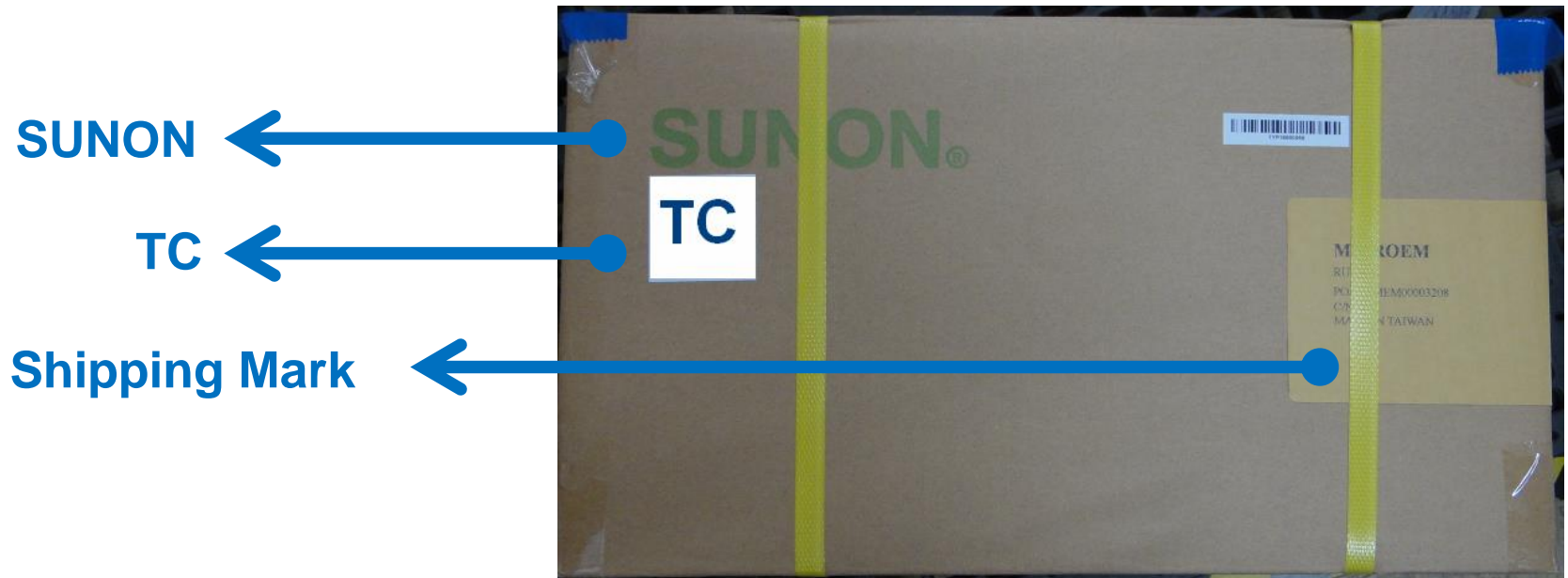

# Description/調整描述 – Mighty Mini Blower – Visible from list

Search Results for: UF3\*

Part #	Uploaded	Ctry	Qty	Distributor
UF3H3-700	09/04/2018	US	745	Avnet
UF3H3-710	09/05/2018		874	Digi-Key Electronics
UF3H3-710 V2	09/05/2018		461	Digi-Key Electronics

When checking from internet or running table as a report, then we could see as following (for example) :

Search Results for: UF3\*

Part #	Uploaded	Ctry	Qty	Distributor
UF3H3-700 TC	10/10/2018	US	1000	Digi-Key

UF3H3-700 TC 10/10/2018 US 1000 Digi-Key

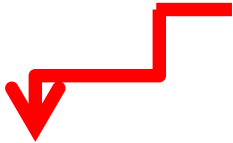

- 1.TC for identify which has tunnel cushion.
- 2.Put the picture which has tunnel cushion.
- 3.Upload DS which has tunnel cushion.

Compare Parts	Image	Digi-Key Part Number		Manufacturer Part Number		Manufacturer		Description	
		▲	▼	▲	▼	▲	▼	▲	▼
<input type="checkbox"/>		<a href="#">259-1676-ND</a>		<a href="#">UF3H3-710</a>		<a href="#">Sunon Fans</a>		FAN AXIAL 17X3MM VAPO 3VDC WIRE	
<input type="checkbox"/>		<a href="#">259-1524-ND</a>		<a href="#">UF3H3-700</a>		<a href="#">Sunon Fans</a>		FAN AXIAL 17X3MM VAPO 3VDC WIRE	
<input type="checkbox"/>		<a href="#">259-1533-ND</a>		<a href="#">UF3H3-500</a>		<a href="#">Sunon Fans</a>		FAN AXIAL 17X3MM VAPO 3VDC WIRE	
<input type="checkbox"/>		<a href="#">259-1834-ND</a>		<a href="#">UF3H3-710 V2</a>		<a href="#">Sunon Fans</a>		FAN TUBEAXIAL 17X3MM VAPO 3VDC	



SUNON®

# Description/調整描述

## Example : DIMENSION OF Data Sheet

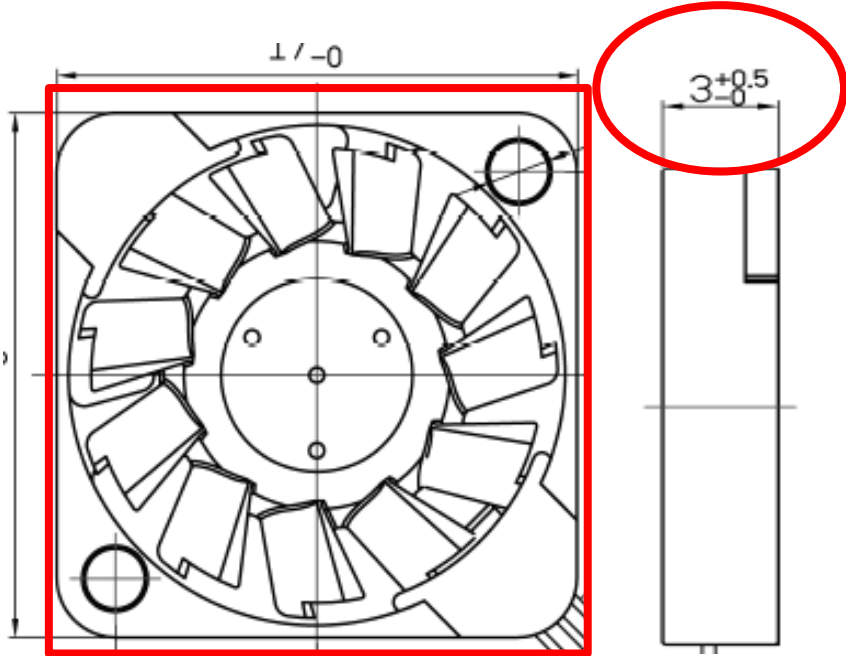
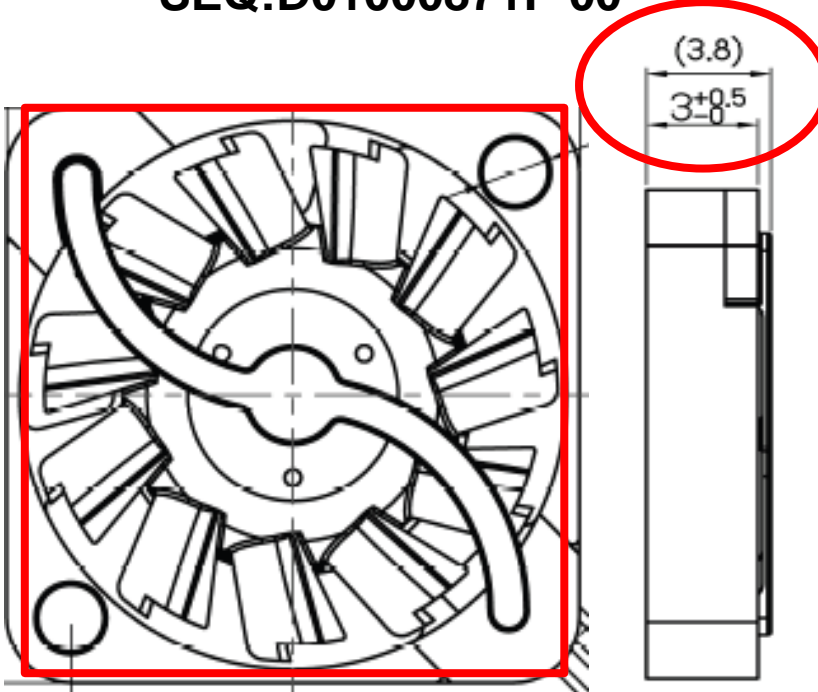
Before	After (Tunnel Cushion)
<p>PN:UF3H3-700 SEQ:D01000871F-00</p> 	<p>PN:UF3H3-700 SEQ:D01000871F-00</p> 

# Tunnel Cushion 入風閘控

M00



M01

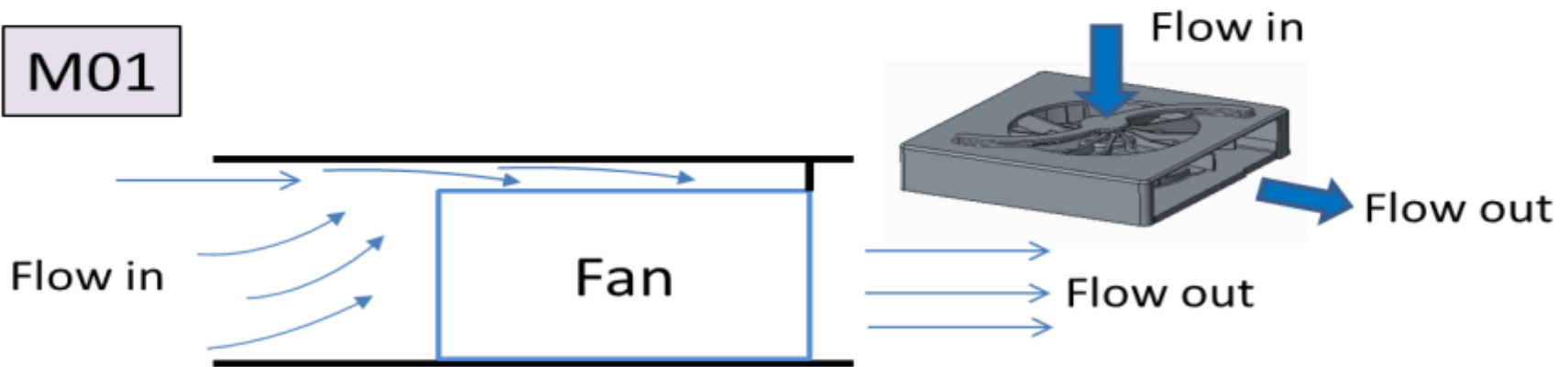

The inlet flow field of M01 is better than M00

# SUNON®

For more information  
please contact your local Sunon sales office  
or visit sunon website:  
[www.sunon.com](http://www.sunon.com)

## Thanks for Your Attention!!



SUNON®