

PLUG MATED TO VERTICAL RECEPTACLE MATED PROFILE

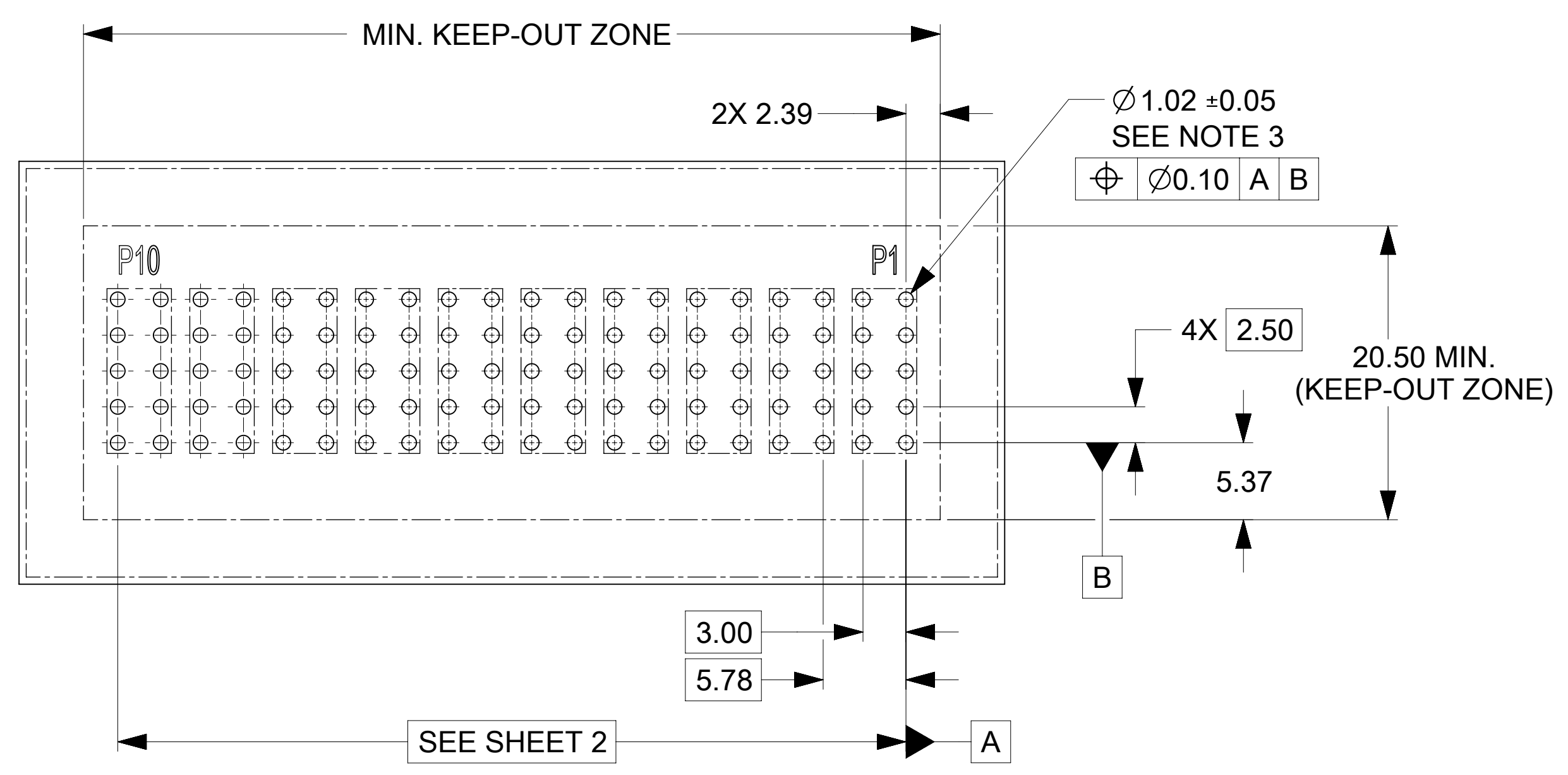

- NOTES:
- MATERIAL:
 - HOUSINGS: LCP UL94, V-0, COLOR : BLACK
 - TERMINALS: HIGH CONDUCTIVITY COPPER ALLOY
 - PLATING: 1.27 μm (50 μin) NICKEL OVERALL WITH
2.54 μm (100 μin) SELECTIVE TIN ON TAILS AND
0.762 μm (30 μin) SELECTIVE GOLD ON CONTACT AREA
 - PACKAGING: ASSEMBLIES TO BE TRAY PACKED PER PACKAGING SPEC: 2141140001-PK.
 - PLATED THRU HOLE SIZE, REFER TO PRODUCT SPEC. FOR DETAILS.
 - PRODUCT SPEC: 2141130000-PS.
 - PRODUCT TO MEET RoHS REQUIREMENTS.
 - VERTICAL ASSEMBLY MATES TO MOLEX PLUG 219562XXXX-SD, SEE DRAWING FOR DETAILS.
 - TAIL DESIGN: COMPLIANT PIN.
 - POWER TERMINALS ARE LUBRICATED.
 - APPLICATION SPECIFICATION: 2141130000-AS (FOR COMPLIANT TAILS ONLY).

THIS DRAWING CONTAINS INFORMATION THAT IS PROPRIETARY TO MOLEX ELECTRONIC TECHNOLOGIES, LLC AND SHOULD NOT BE USED WITHOUT WRITTEN PERMISSION											
DIMENSION UNITS		SCALE		CURRENT REV DESC:							
mm		3:1									
GENERAL TOLERANCES (UNLESS SPECIFIED)											
ANGULAR TOL ± °											
4 PLACES		±		EC NO: 745288							
3 PLACES		±		DRWN: LZABJANOVSKI		2023/03/23					
2 PLACES		± 0.25		CHK'D: JAYK1		2023/04/10					
1 PLACE		± 0.3		APPR: JAYK1		2023/04/10					
0 PLACES		±		INITIAL REVISION:							
				DRWN: LZABJANOVSKI		2022/03/30					
				APPR: BPISZCZOR		2022/08/04					
DRAFT WHERE APPLICABLE MUST REMAIN WITHIN DIMENSIONS				THIRD ANGLE PROJECTION		DRAWING		SERIES		MATERIAL NUMBER	
				D-SIZE		219563		SEE CHART		CUSTOMER	
										SHEET NUMBER	
										1 OF 2	

RECOMMENDED PCB LAYOUT AND KEEP-OUT ZONE

PART NUMBER	CONFIGURATION	QUANTITY PER CARTON (DU)
219563-0031	1P	820

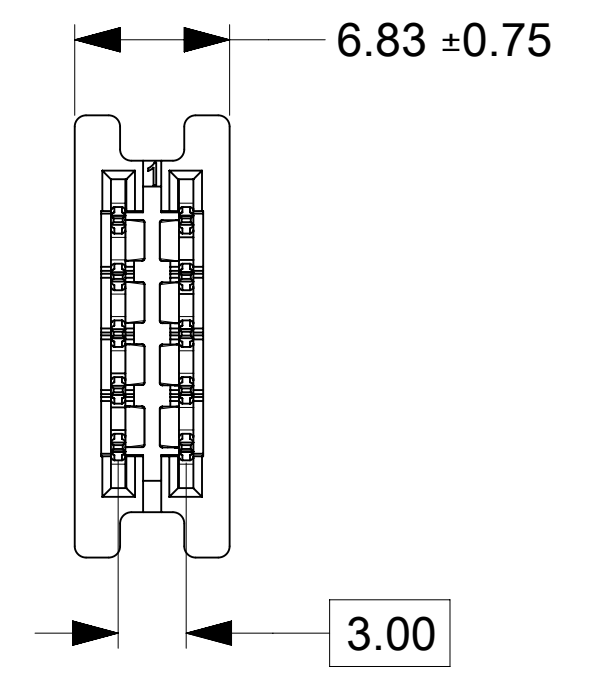

PART NUMBER	CONFIGURATION	QUANTITY PER CARTON (DU)
219563-0032	2P	440

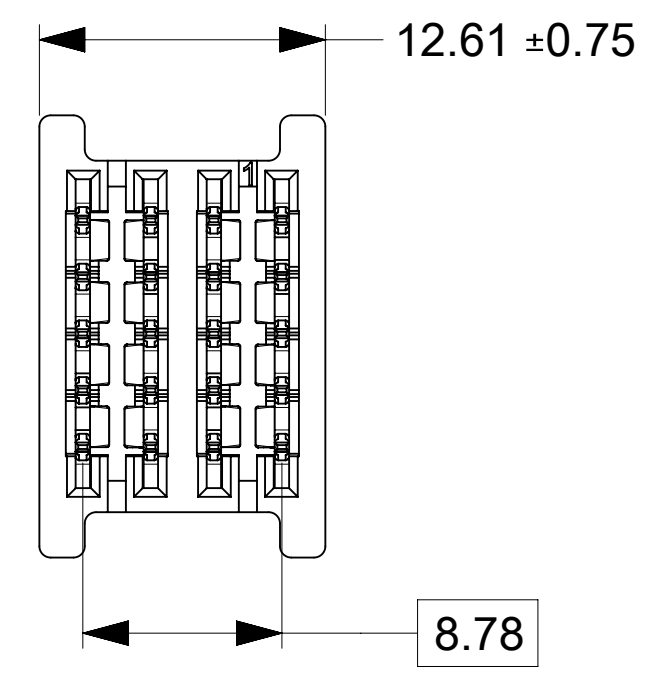

PART NUMBER	CONFIGURATION	QUANTITY PER CARTON (DU)
219563-0033	3P	300

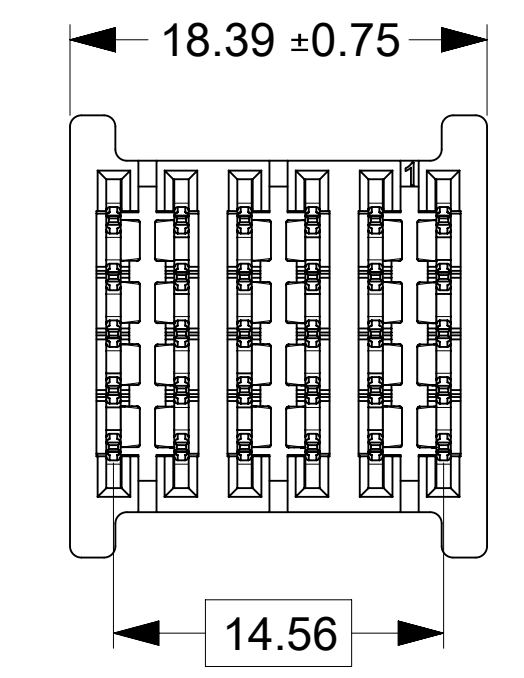

PART NUMBER	CONFIGURATION	QUANTITY PER CARTON (DU)
219563-0034	4P	220

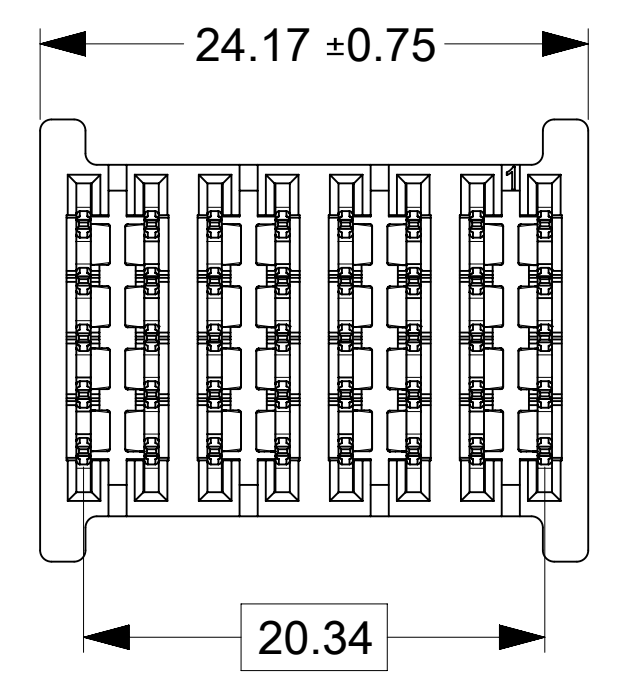

PART NUMBER	CONFIGURATION	QUANTITY PER CARTON (DU)
219563-0035	5P	180

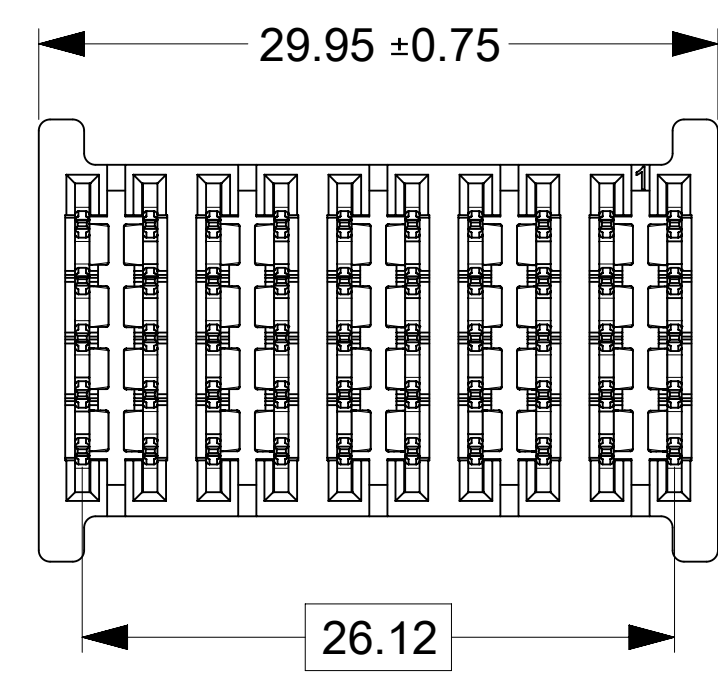

PART NUMBER	CONFIGURATION	QUANTITY PER CARTON (DU)
219563-0036	6P	140

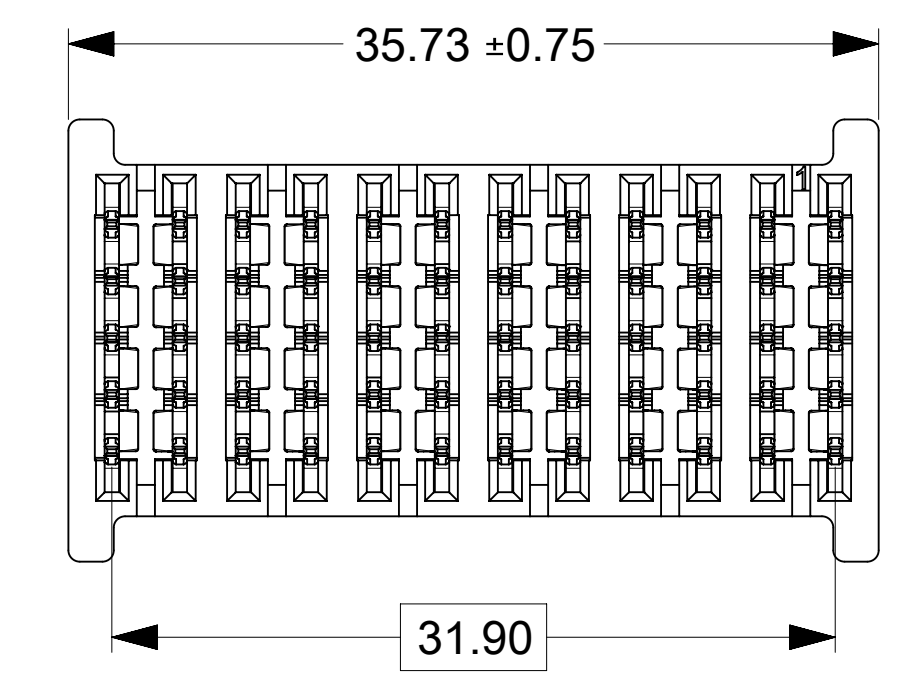

PART NUMBER	CONFIGURATION	QUANTITY PER CARTON (DU)
219563-0037	7P	120

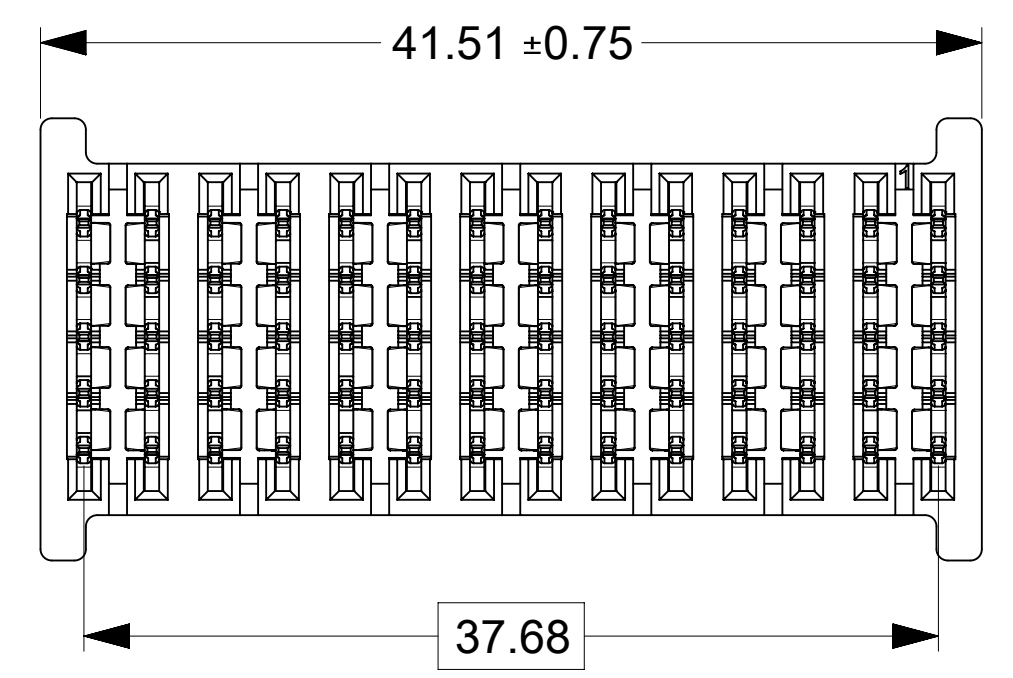

PART NUMBER	CONFIGURATION	QUANTITY PER CARTON (DU)
219563-0038	8P	100

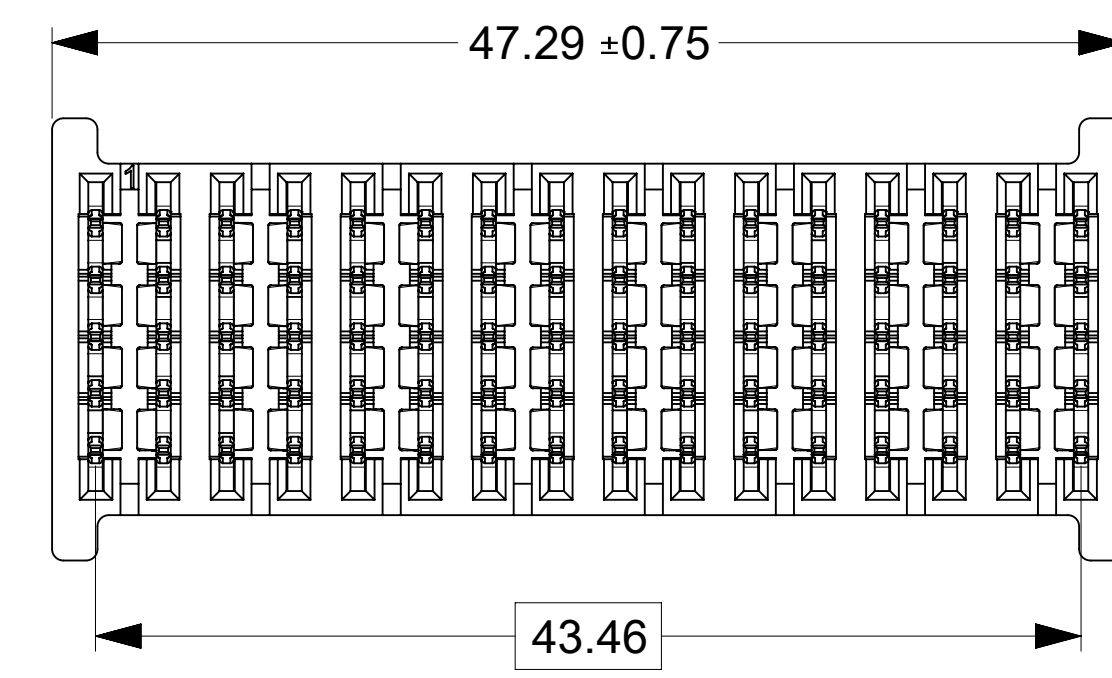

PART NUMBER	CONFIGURATION	QUANTITY PER CARTON (DU)
219563-0039	9P	100

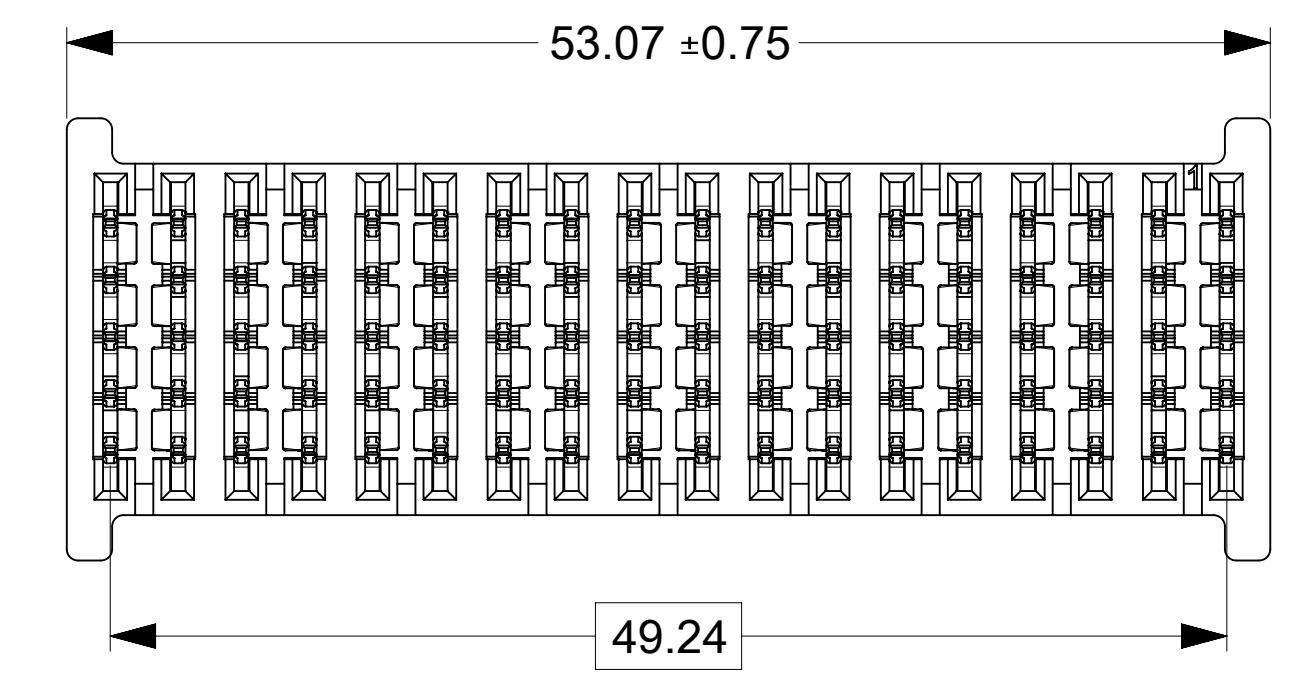

PART NUMBER	CONFIGURATION	QUANTITY PER CARTON (DU)
219563-0040	10P	80

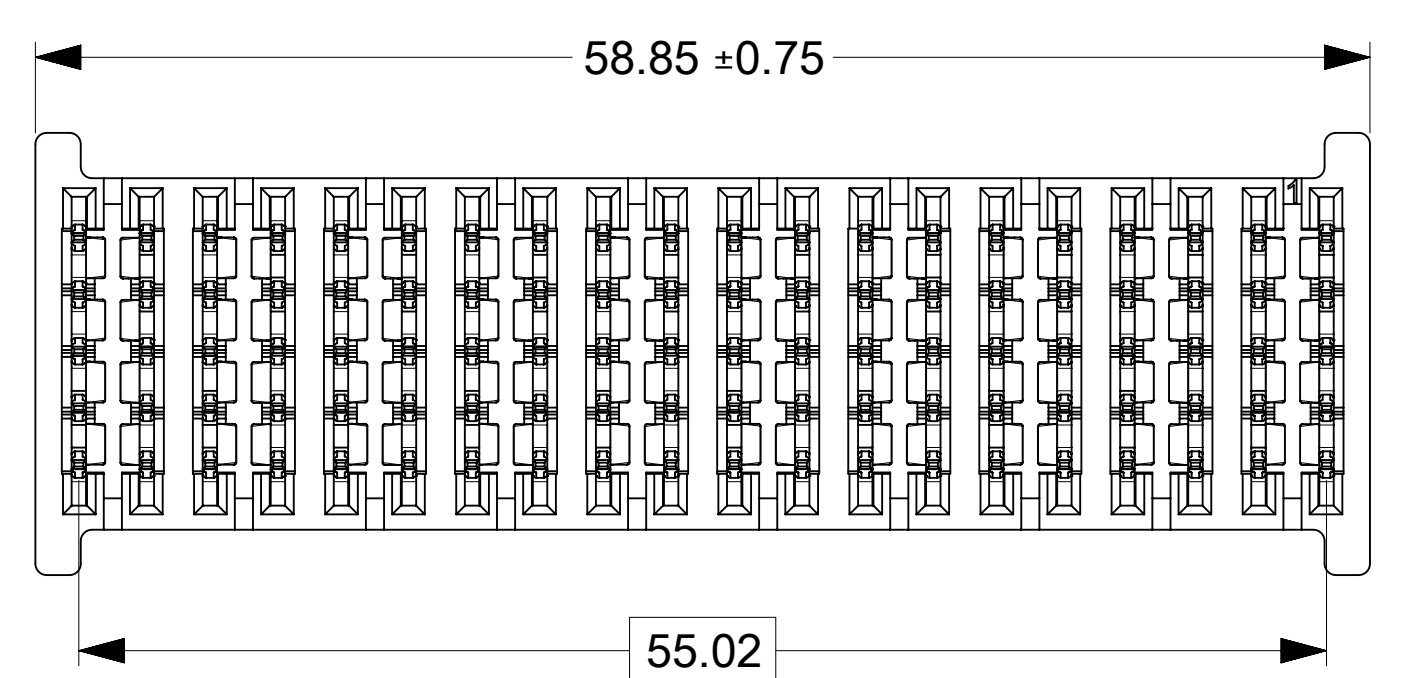

*** VIEWS SHOWN ON THIS SHEET ARE FROM THE BOTTOM OF THE CONNECTOR**

THIS DRAWING CONTAINS INFORMATION THAT IS PROPRIETARY TO MOLEX ELECTRONIC TECHNOLOGIES, LLC AND SHOULD NOT BE USED WITHOUT WRITTEN PERMISSION													
DIMENSION UNITS		SCALE		CURRENT REV DESC:									
mm		3:1											
GENERAL TOLERANCES (UNLESS SPECIFIED)													
ANGULAR TOL ± °													
4 PLACES		±		EC NO: 745288									
3 PLACES		±		DRWN: LZABJANOVSKI				2023/03/23					
2 PLACES		± 0.25		CHK'D: JAYK1				2023/04/10					
1 PLACE		± 0.3		APPR: JAYK1				2023/04/10					
0 PLACES		±		INITIAL REVISION:									
				DRWN: LZABJANOVSKI				2022/03/30					
				APPR: BPISZCZOR				2022/08/04					
DRAFT WHERE APPLICABLE MUST REMAIN WITHIN DIMENSIONS			THIRD ANGLE PROJECTION		DRAWING		SERIES		MATERIAL NUMBER			CUSTOMER	
					D-SIZE		219563		SEE CHART			SHEET NUMBER	
												2 OF 2	

molex

GUARDIAN HD VREC POWER ONLY
UNGUIDED PF

PRODUCT CUSTOMER DRAWING

DOCUMENT NUMBER	DOC TYPE	DOC PART	REVISION
2195639003-SD	PSD	000	A2

DOCUMENT STATUS	P1	RELEASE DATE	2023/04/11	17:05:26
-----------------	----	--------------	------------	----------