

6 5 4 3 2 1

APPROVED: _____
 DATE: _____ TITLE: _____

Rev	AWO #	Description	Date	Appr
-		RELEASED	5/15/20	

RECOMMENDED PCB LAYOUT

(1.60) EJECT BAR STROKE
 (1.8mm TRAY EJECT STROKE)
 (3.0) TRAY PUSH-IN POSITION
 (4.8) TRAY EJECT POSITION
 (0.5)
 CONNECTOR CENTER
 CARD CENTER
 0.09

PIN NUMBER		PIN ASSIGNMENT
1# SIM	2# SIM	
IC1	2C1	Vcc
IC2	2C2	RST
IC3	2C3	CLK
IC5	2C5	GND
IC6	2C6	Vpp
IC7	2C7	I/O
ICd	2Cd	DETECTION PIN

SPECIFICATIONS:

Material:
 Insulation: Hi-Temp Thermoplastic, UL94V-0
 Insulation color: Black
 Contact: Copper Alloy
 Shell: Stainless Steel, Nickel plated, Gold plated on solder area
 Bar: Stainless Steel
 Cam: Stainless Steel
 Plating:

30u" Gold over Nickel underplate on contact area,
 Gold flash over Nickel underplate on solder tails
 Electrical:

Voltage rating: 10 V AC/DC
 Current rating: 0.5 Amp max
 Contact resistance: 50 mohms max
 Insulation resistance: 1,000 Mohms min
 Dielectric withstanding voltage: 500 VAC for 1 minute
 Temperature Rating:
 Operating temperature: -40°C to +105°C
 Environmental:
 Lead free, RoHS compliant

PACKAGED ON TAPE & REEL

UNLESS OTHERWISE SPECIFIED ALL DIMENSIONS ARE MILLIMETERS TOLERANCES: EXCEPT AS NOTED		ADAM TECH 909 Rahway Avenue, Union, NJ 07083 Phone: 908-687-5000 Fax: 908-687-5710	
MM ANGLE .X ± 0.30 .X ± 3° .XX ± 0.20 .X ± 1° .XXX ± 0.10		INTERCONNECTS	
APPROVALS		TITLE	
DRAWN	LH	NANO SIM CARD CONNECTOR, PUSH PULL DUAL CARD, 14 PIN, GOLD PLATED, SMT TYPE	
CHECKED	RC	DATE	5/15/20
APPROVED		SIZE	X
		PART NO.	NSSC-DC-14-G-SMT-T/R
		REF:	S00275T
		SCALE:	NTS
		SHEET	1 OF 5

6 5 4 3 2 1

APPROVED: _____
 DATE: _____ TITLE: _____

Rev	AWO #	Description	Date	Appr
SEE SHT 1 OF 5 FOR REVISION				

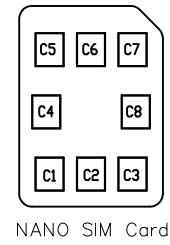
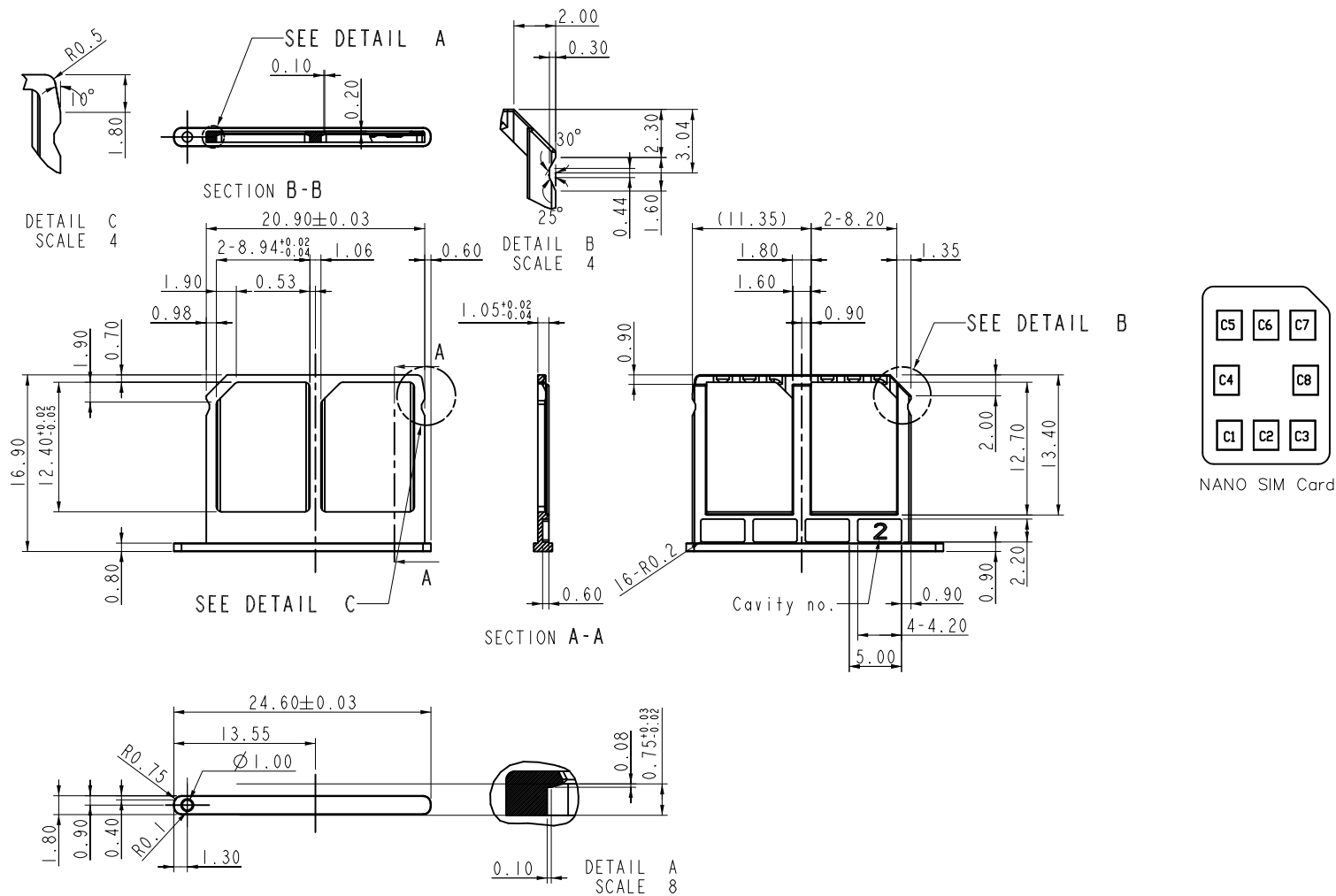

SPECIFICATIONS:
 Material: SUS316, Color: Natural
 Environmental:
 Lead free, RoHS compliant

UNLESS OTHERWISE SPECIFIED
 ALL DIMENSIONS ARE MILLIMETERS
 TOLERANCES: EXCEPT AS NOTED

MM	ANGLE
.X ± 0.30	.X ± 3°
.XX ± 0.20	.X ± 1°
.XXX ± 0.10	

APPROVALS		DATE
DRAWN	LH	5/15/20
CHECKED	RC	5/15/20
APPROVED		

ADAM TECH INTERCONNECTS 909 Rahway Avenue,
 Union, NJ 07083
 Phone: 908-687-5000
 Fax: 908-687-5710

TITLE: NANO SIM CARD CONNECTOR, PUSH PULL
 DUAL CARD, 14 PIN, GOLD PLATED, SMT TYPE

SIZE X	PART NO. NSCC-DC-14-G-SMT-T/R	REV. -
-----------	----------------------------------	-----------

REF: S00275T SCALE: NTS SHEET 2 OF 5

6

5

4

3

2

1

APPROVED: _____

DATE: _____ TITLE: _____

Rev	AWO #	Description	Date	Appr
-----	-------	-------------	------	------

SEE SHT 1 OF 5 FOR REVISION

D

D

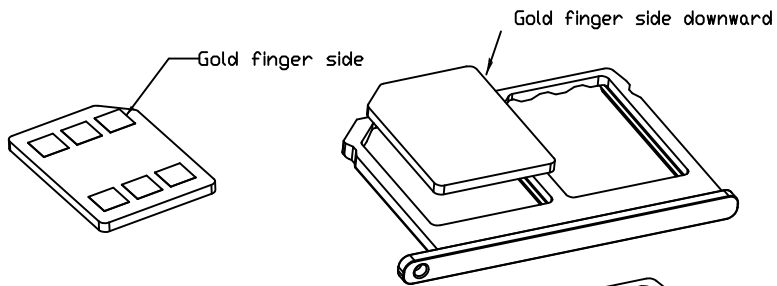

C

C

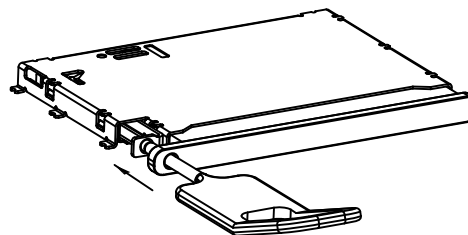
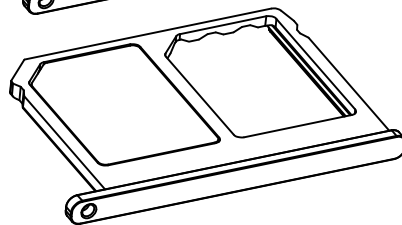

B

B

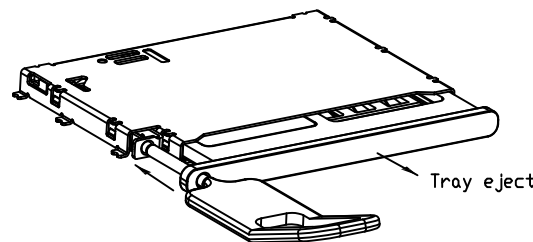
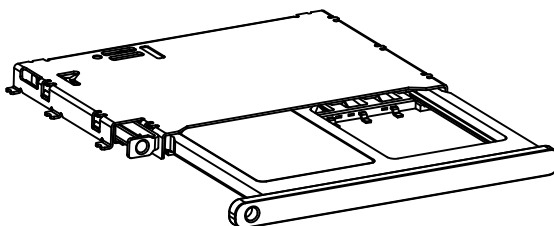

A

A

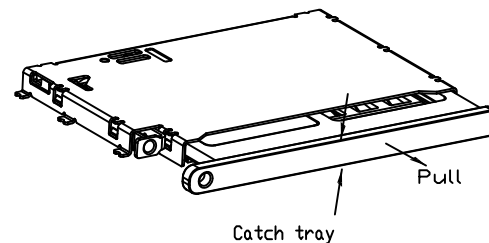
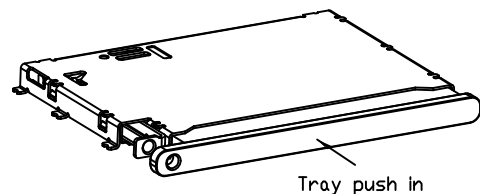

UNLESS OTHERWISE SPECIFIED
ALL DIMENSIONS ARE MILLIMETERS
TOLERANCES: EXCEPT AS NOTED

MM	ANGLE
.X ± 0.30	X. ± 3°
.XX ± 0.20	.X ± 1°
.XXX ± 0.10	

ADAM TECH
INTERCONNECTS

909 Rahway Avenue,
Union, NJ 07083
Phone: 908-687-5000
Fax: 908-687-5710

APPROVALS		DATE
DRAWN	LH	5/15/20
CHECKED	RC	5/15/20
APPROVED		

TITLE		
NANO SIM CARD CONNECTOR, PUSH PULL DUAL CARD, 14 PIN, GOLD PLATED, SMT TYPE		
SIZE	PART NO.	REV.
X	NSCC-DC-14-G-SMT-T/R	-
REF: S00275T	SCALE: NTS	SHEET 3 OF 5

6

5

4

3

2

1

6

5

4

3

2

1

APPROVED: _____

DATE: _____ TITLE: _____

Rev	AWO #	Description	Date	Appr
-----	-------	-------------	------	------

SEE SHT 1 OF 5 FOR REVISION

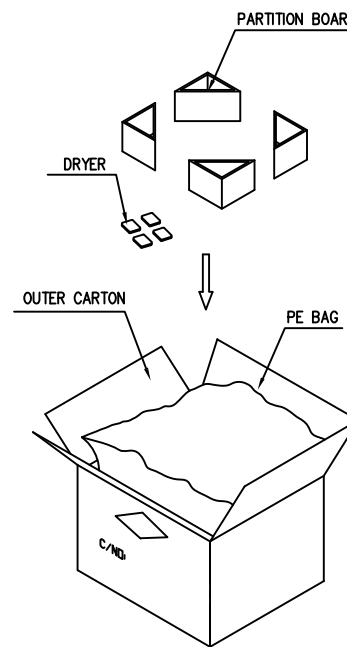
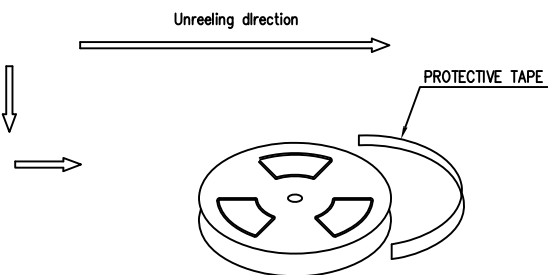
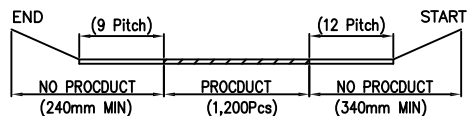
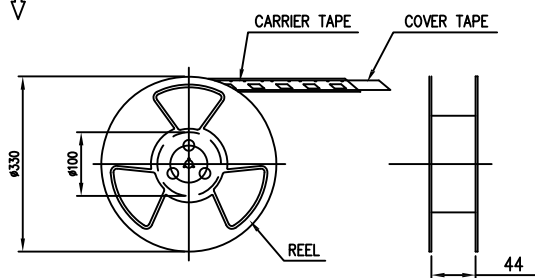
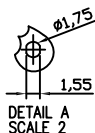
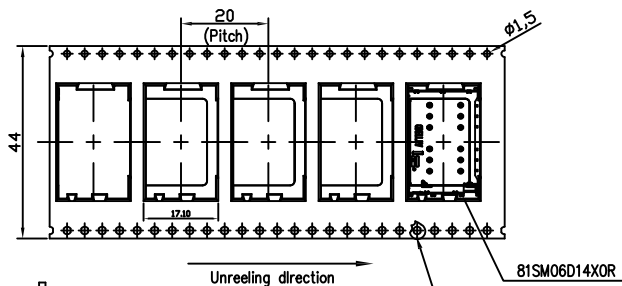

NOTES:

1. PACKING STYLE: 1,200 PCS/REEL
7,200 PCS/OUTER CARTON
2. MATERIAL: CARRIER TAPE: PS BLACK
COVER TAPE: PET FILM
REEL: PLASTIC
3. PEEL STRENGTH OF COVER TAPE: 20~80g(PEEL SPEED 300mm/MINUTE)
4. CARTON SIZE: 350x350x320mm

UNLESS OTHERWISE SPECIFIED
ALL DIMENSIONS ARE MILLIMETERS
TOLERANCES: EXCEPT AS NOTED

MM	ANGLE
.X ± 0.30	X. ± 3°
.XX ± 0.20	.X ± 1°
.XXX ± 0.10	

ADAM TECH
INTERCONNECTS

909 Rahway Avenue,
Union, NJ 07083
Phone: 908-687-5000
Fax: 908-687-5710

APPROVALS		DATE
DRAWN	LH	5/15/20
CHECKED	RC	5/15/20
APPROVED		

TITLE		
NANO SIM CARD CONNECTOR, PUSH PULL DUAL CARD, 14 PIN, GOLD PLATED, SMT TYPE		
SIZE	PART NO.	REV.
X	NSCC-DC-14-G-SMT-T/R	-
REF: S00275T	SCALE: NTS	SHEET 4 OF 5

6

5

4

3

2

1

6

5

4

3

2

1

APPROVED: _____

DATE: _____ TITLE: _____

Rev	AWO #	Description	Date	Appr
-----	-------	-------------	------	------

SEE SHT 1 OF 5 FOR REVISION

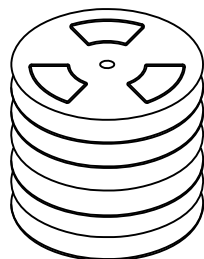
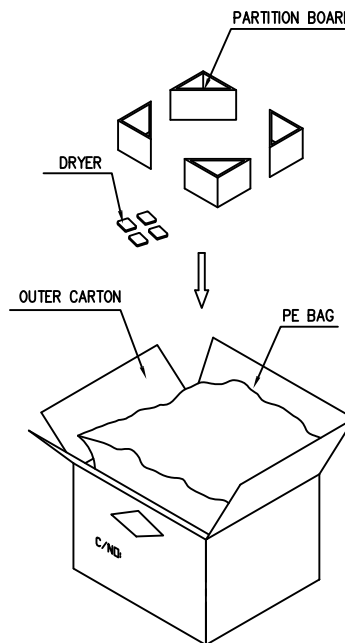
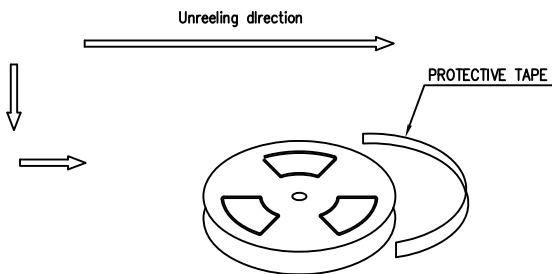
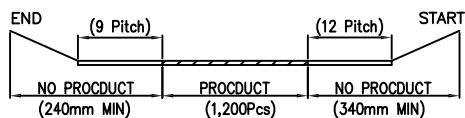
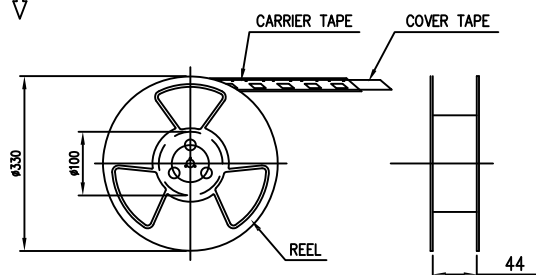
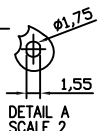
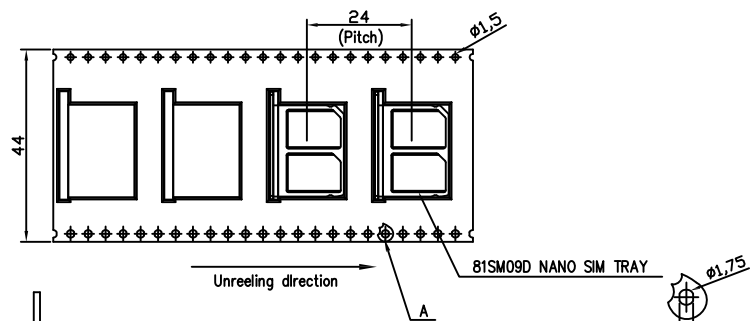

NOTES:

- PACKING STYLE: 1,200 PCS/REEL
7,200 PCS/OUTER CARTON
- MATERIAL: CARRIER TAPE: PS BLACK
COVER TAPE: PET FILM
REEL: PLASTIC
- PEEL STRENGTH OF COVER TAPE: 20~80g(PEEL SPEED 300mm/MINUTE)
- CARTON SIZE: 350x350x320mm

UNLESS OTHERWISE SPECIFIED
ALL DIMENSIONS ARE MILLIMETERS
TOLERANCES: EXCEPT AS NOTED

MM	ANGLE
.X ± 0.30	X. ± 3°
.XX ± 0.20	.X ± 1°
.XXX ± 0.10	

ADAM TECH
INTERCONNECTS

909 Rahway Avenue,
Union, NJ 07083
Phone: 908-687-5000
Fax: 908-687-5710

APPROVALS		DATE
DRAWN	LH	5/15/20
CHECKED	RC	5/15/20
APPROVED		

TITLE		
NANO SIM CARD CONNECTOR, PUSH PULL DUAL CARD, 14 PIN, GOLD PLATED, SMT TYPE		
SIZE	PART NO.	REV.
X	NSSC-DC-14-G-SMT-T/R	-
REF: S00275T	SCALE: NTS	SHEET 5 OF 5

6

5

4

3

2

1