

## IGBT 4 Pack Module, 75 A

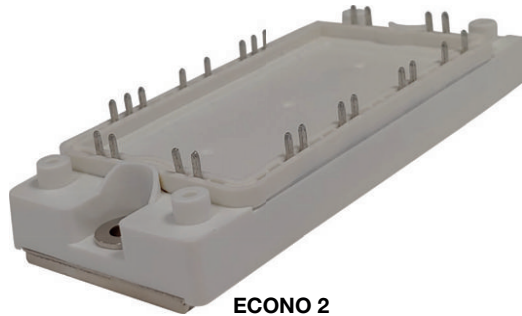

**ECONO 2**  
(Package example)

### FEATURES

- Trench gate field stop
- Square RBSOA
- HEXFRED® low  $Q_{rr}$ , low switching energy
- Positive  $V_{CE(on)}$  temperature coefficient
- Copper baseplate
- Low stray inductance design
- Material categorization: for definitions of compliance please see [www.vishay.com/doc?99912](http://www.vishay.com/doc?99912)



**RoHS**  
COMPLIANT

### PRIMARY CHARACTERISTICS

$V_{CES}$	1200 V
$I_C$ at $T_C = 87\text{ °C}$	75 A
$V_{CE(on)}$ (typical)	2.20 V
Speed	8 kHz to 30 kHz
Package	ECONO 2
Circuit configuration	4 pack with thermistor

### BENEFITS

- Benchmark efficiency for SMPS application in particular HF welding
- Rugged transient performance
- Low EMI, requires less snubbing
- Direct mounting to heatsink space saving
- PCB solderable terminals
- Low junction to case thermal resistance

### ABSOLUTE MAXIMUM RATINGS

PARAMETER	SYMBOL	TEST CONDITIONS	MAX.	UNITS
Collector to emitter voltage	$V_{CES}$		1200	V
Continuous collector current	$I_C$	$T_C = 25\text{ °C}$	118	A
		$T_C = 80\text{ °C}$	81	
Pulsed collector current (See fig. C.T.5)	$I_{CM}$	$T_J = 150\text{ °C}$ , $t_p = 6\text{ ms}$ , $V_{GE} = 15\text{ V}$	270	
Clamped inductive load current	$I_{LM}$		250	
Diode continuous forward current	$I_F$	$T_C = 25\text{ °C}$	60	
		$T_C = 80\text{ °C}$	40	
Diode maximum forward current	$I_{FM}$		150	
Gate to emitter voltage	$V_{GE}$		$\pm 20$	V
Maximum power dissipation (IGBT)	$P_D$	$T_C = 25\text{ °C}$	431	W
		$T_C = 80\text{ °C}$	241	
Isolation voltage	$V_{ISOL}$		AC 2500 (min)	V



<b>ELECTRICAL SPECIFICATIONS</b> ( $T_J = 25\text{ }^\circ\text{C}$ unless otherwise specified)						
PARAMETER	SYMBOL	TEST CONDITIONS	MIN.	TYP.	MAX.	UNITS
Collector to emitter breakdown voltage	$V_{BR(CEs)}$	$V_{GE} = 0\text{ V}, I_C = 4\text{ mA}$	1200	-	-	V
Collector to emitter voltage	$V_{CE(on)}$	$I_C = 75\text{ A}, V_{GE} = 15\text{ V}$	-	2.20	2.60	
		$I_C = 75\text{ A}, V_{GE} = 15\text{ V}, T_J = 125\text{ }^\circ\text{C}$	-	2.44	-	
Gate threshold voltage	$V_{GE(th)}$	$V_{CE} = V_{GE}, I_C = 4\text{ mA}$	4.6	5.9	7.6	
Threshold voltage temperature coefficient	$\Delta V_{GE(th)}/\Delta T_J$	$V_{CE} = V_{GE}, I_C = 4\text{ mA}$ (25 °C to 125 °C)	-	-13	-	mV/°C
Zero gate voltage collector current	$I_{CES}$	$V_{GE} = 0\text{ V}, V_{CE} = 1200\text{ V}$	-	1.4	100	μA
		$V_{GE} = 0\text{ V}, V_{CE} = 1200\text{ V}, T_J = 125\text{ }^\circ\text{C}$	-	1130	-	
Diode forward voltage drop	$V_{FM}$	$I_F = 75\text{ A}$	-	3.7	4.9	V
		$I_F = 75\text{ A}, T_J = 125\text{ }^\circ\text{C}$	-	3.7	-	
Gate to emitter leakage current	$I_{GES}$	$V_{GE} = \pm 20\text{ V}$	-	-	± 200	nA

<b>SWITCHING CHARACTERISTICS</b> ( $T_J = 25\text{ }^\circ\text{C}$ unless otherwise noted)						
PARAMETER	SYMBOL	TEST CONDITIONS	MIN.	TYP.	MAX.	UNITS
Total gate charge (turn-on)	$Q_G$	$I_C = 75\text{ A}$ $V_{CC} = 960\text{ V}$ $V_{GE} = 15\text{ V}$	-	333	-	nC
Gate to emitter charge (turn-on)	$Q_{GE}$		-	36	-	
Gate to collector charge (turn-on)	$Q_{GC}$		-	173	-	
Turn-on switching loss	$E_{on}$	$I_C = 75\text{ A}, V_{CC} = 600\text{ V}$ $V_{GE} = 15\text{ V}, R_g = 5\text{ }^\Omega, L = 500\text{ }^\mu\text{H}$ $T_J = 25\text{ }^\circ\text{C}$ (1)	-	1.85	-	mJ
Turn-off switching loss	$E_{off}$		-	2.51	-	
Total switching loss	$E_{tot}$		-	4.36	-	
Turn-on switching loss	$E_{on}$	$I_C = 75\text{ A}, V_{CC} = 600\text{ V}$ $V_{GE} = 15\text{ V}, R_g = 5\text{ }^\Omega, L = 500\text{ }^\mu\text{H}$ $T_J = 125\text{ }^\circ\text{C}$ (1)	-	3.17	-	mJ
Turn-off switching loss	$E_{off}$		-	4.23	-	
Total switching loss	$E_{tot}$		-	7.40	-	
Turn-on delay time	$t_{d(on)}$	$I_C = 75\text{ A}, V_{CC} = 600\text{ V}$ $V_{GE} = 15\text{ V}, R_g = 5\text{ }^\Omega, L = 500\text{ }^\mu\text{H}$ $T_J = 125\text{ }^\circ\text{C}$	-	92	-	ns
Rise time	$t_r$		-	20	-	
Turn-off delay time	$t_{d(off)}$		-	153	-	
Fall time	$t_f$		-	178	-	
Reverse bias safe operating area	RBSOA	$T_J = 150\text{ }^\circ\text{C}, I_C = 250\text{ A}, V_{CC} = 700\text{ V},$ $V_P = 1200\text{ V}, R_g = 10\text{ }^\Omega,$ $V_{GE} = 15\text{ V to } 0\text{ V}$	Fullsquare			
Short circuit safe operating area	SCSOA	$T_J = 150\text{ }^\circ\text{C}, V_{CC} = 600\text{ V}, V_P = 1200\text{ V}$ $R_g = 10\text{ }^\Omega, V_{GE} = 15\text{ V to } 0\text{ V}$	10	-	-	μs
Diode peak reverse recovery current	$I_{rr}$	$T_J = 25\text{ }^\circ\text{C}$	-	13	-	A
		$T_J = 125\text{ }^\circ\text{C}$	-	19	-	
Diode reverse recovery time	$t_{rr}$	$T_J = 25\text{ }^\circ\text{C}$	-	132	-	ns
		$T_J = 125\text{ }^\circ\text{C}$	-	200	-	
Total reverse recovery charge	$Q_{rr}$	$T_J = 25\text{ }^\circ\text{C}$	-	858	-	nC
		$T_J = 125\text{ }^\circ\text{C}$	-	1900	-	

**Note**

(1) Energy losses include "tail" and diode reverse recovery

<b>INTERNAL NTC - THERMISTOR SPECIFICATIONS</b>				
PARAMETER	SYMBOL	TEST CONDITIONS	VALUE	UNITS
Resistance	R25	$T_C = 25\text{ }^\circ\text{C}$	5000	Ω
	R100	$T_C = 100\text{ }^\circ\text{C}$	493 ± 5 %	
B-value	$B_{25/50}$	$R_2 = R_{25} \text{ exp. } [B_{25/50} (1/T_2 - 1/(298.15\text{ K}))]$	3375 ± 5 %	K
Maximum operating temperature			220	°C
Dissipation constant			2	mW/°C
Thermal time constant			8	s



THERMAL AND MECHANICAL SPECIFICATIONS					
PARAMETER	SYMBOL	MIN.	TYP.	MAX.	UNITS
Junction and storage temperature range	$T_J, T_{Stg}$	-40	-	150	°C
Junction-to-case IGBT	$R_{thJC}$	-	-	0.29	°C/W
Junction-to-case diode	$R_{thJC}$	-	-	0.56	
Case to sink per module	$R_{thCS}$	-	0.02	-	
Mounting torque (M5)		2.7	-	3.3	Nm
Weight		-	170	-	g

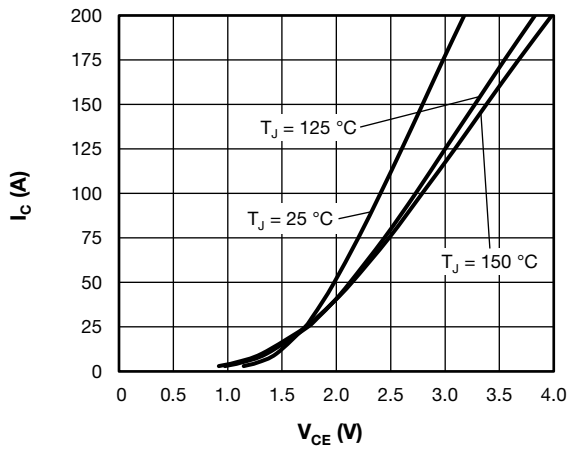

Fig. 1 - Typical Trench IGBT Output Characteristics,  $V_{GE} = 15\text{ V}$

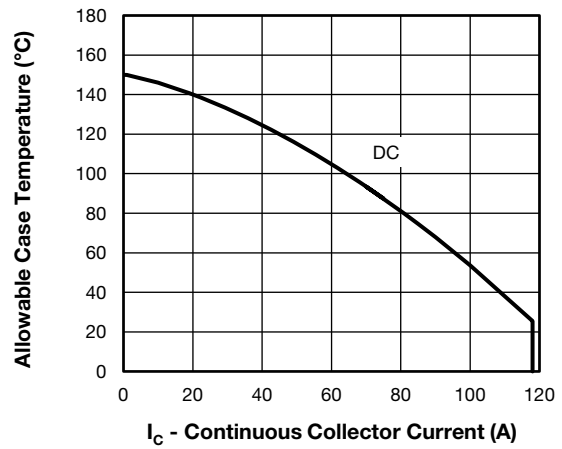

Fig. 3 - Maximum Trench IGBT Continuous Collector Current vs. Case Temperature

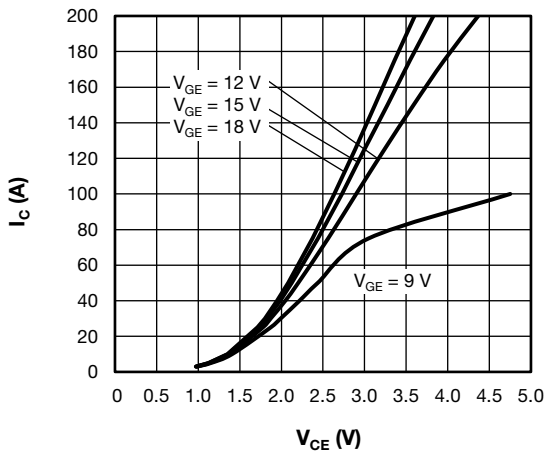

Fig. 2 - Typical Trench IGBT Output Characteristics,  $T_J = 125\text{ °C}$

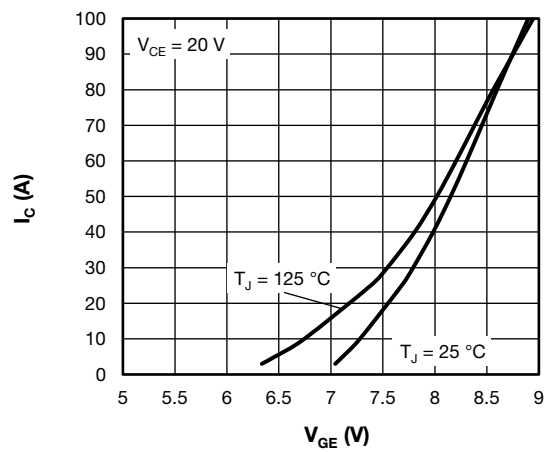

Fig. 4 - Typical Trench IGBT Transfer Characteristics

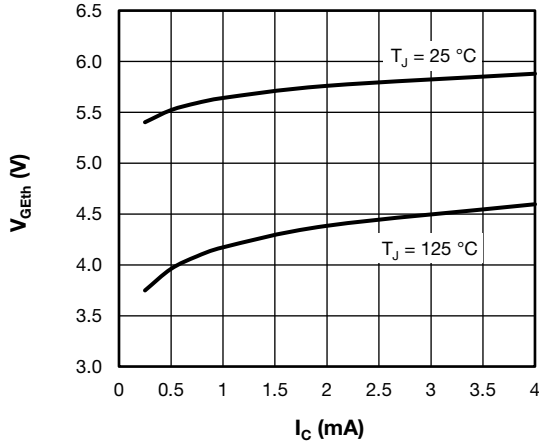

Fig. 5 - Typical Trench IGBT Gate Threshold Voltage

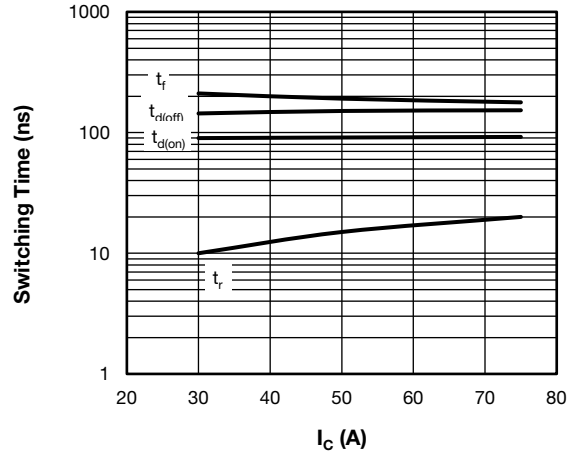

Fig. 8 - Typical Trench IGBT Switching Time vs.  $I_C$   
(with Antiparallel Diode)  
 $T_J = 125^\circ C$ ,  $V_{CC} = 600 V$ ,  $R_g = 4.7 \Omega$ ,  $V_{GE} = +15V/-15V$ ,  $L = 500 \mu H$

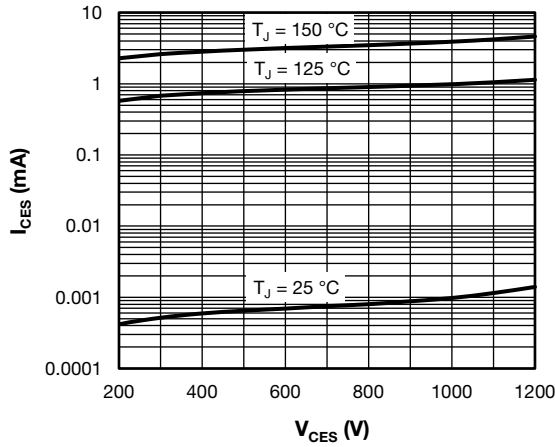

Fig. 6 - Typical Trench IGBT Zero Gate Voltage Collector Current

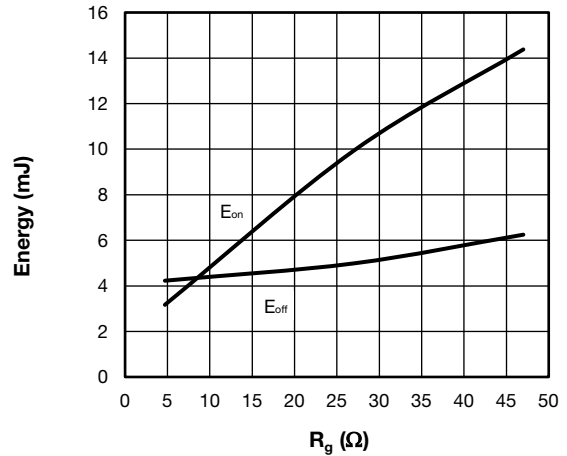

Fig. 9 - Typical Trench IGBT Energy Loss vs.  $R_g$   
(with Antiparallel Diode)  
 $T_J = 125^\circ C$ ,  $V_{CC} = 600 V$ ,  $I_C = 75 A$ ,  $V_{GE} = +15V/-15V$ ,  $L = 500 \mu H$

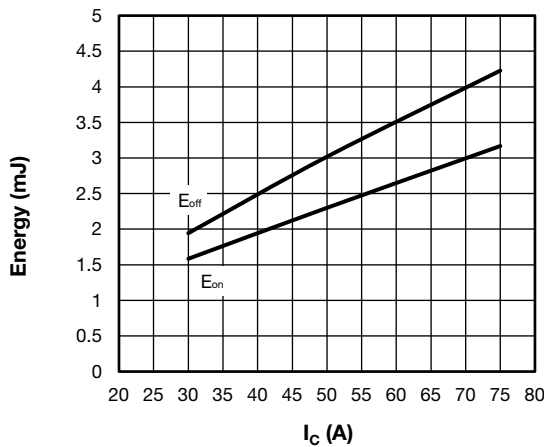

Fig. 7 - Typical Trench IGBT Energy Loss vs.  $I_C$   
(with Antiparallel Diode)  
 $T_J = 125^\circ C$ ,  $V_{CC} = 600 V$ ,  $R_g = 4.7 \Omega$ ,  $V_{GE} = +15V/-15V$ ,  $L = 500 \mu H$

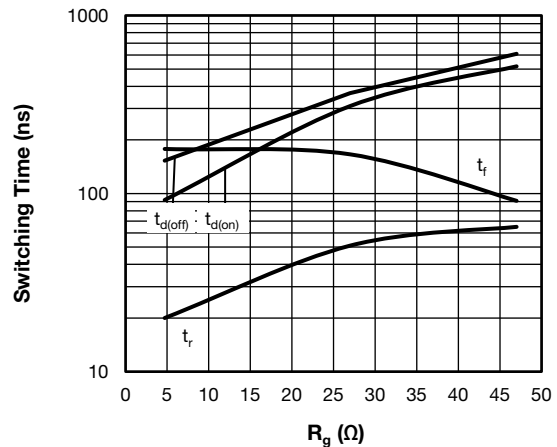

Fig. 10 - Typical Trench IGBT Switching Time vs.  $R_g$   
(with Antiparallel Diode)  
 $T_J = 125^\circ C$ ,  $V_{CC} = 600 V$ ,  $I_C = 75 A$ ,  $V_{GE} = +15V/-15V$ ,  $L = 500 \mu H$

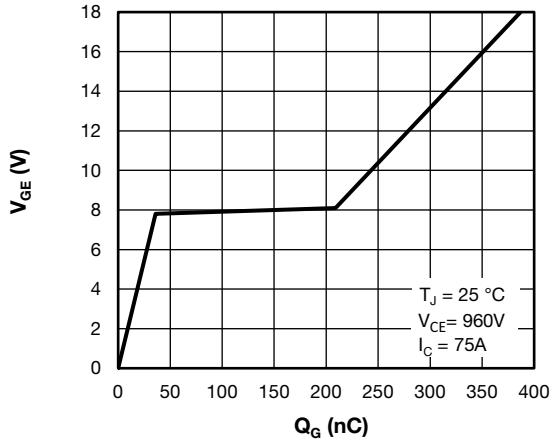

Fig. 11 - Typical Trench IGBT Gate charge vs. Gate to Emitter Voltage

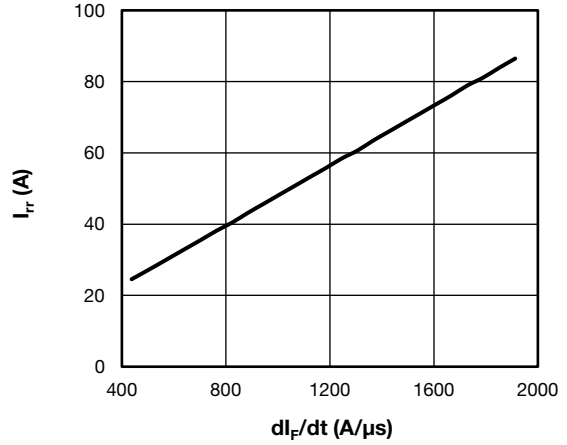

Fig. 14 - Typical Diode  $I_{rr}$  vs.  $dI_F/dt$   
 $V_{CC} = 400\text{V}$ ;  $V_{GE} = 15\text{V}$ ;  $I_{CE} = 5.0\text{A}$ ;  $T_J = 150\text{ }^\circ\text{C}$

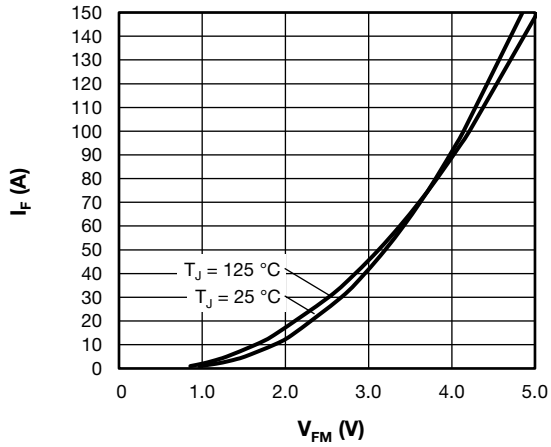

Fig. 12 - Typical Diode Forward Characteristics  
 $t_p = 80\text{ }\mu\text{s}$

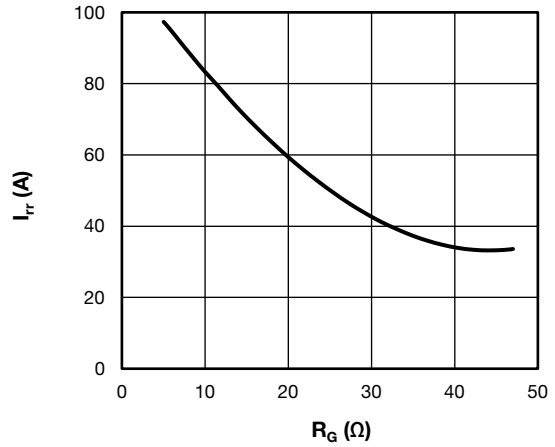

Fig. 15 - Typical Diode  $I_{rr}$  vs.  $R_G$   
 $T_J = 150\text{ }^\circ\text{C}$ ;  $I_F = 5.0\text{A}$

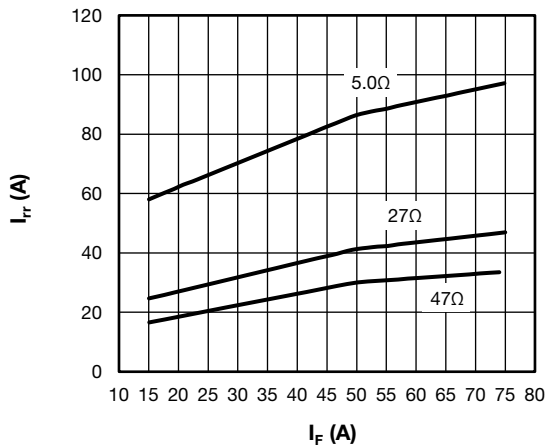

Fig. 13 - Typical Diode  $I_{rr}$  vs.  $I_F$ ,  
 $T_J = 150\text{ }^\circ\text{C}$

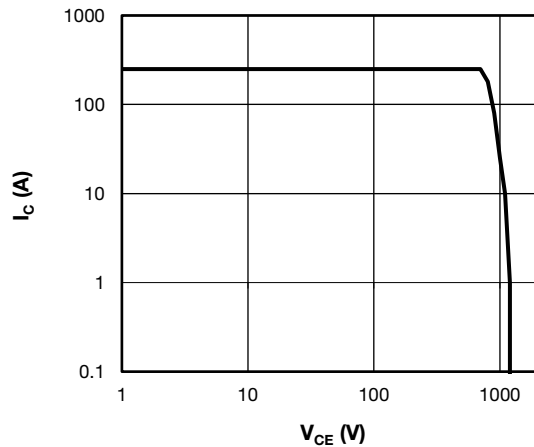

Fig. 16 - Trench IGBT Reverse BIAS SOA  
 $T_J = 150\text{ }^\circ\text{C}$ ,  $I_C = 250\text{A}$ ,  $R_G = 10\text{ }\Omega$ ,  $V_{GE} = +15\text{V}$ ,  $V_{CC} = 700\text{V}$ ,  
 $V_p = 1200\text{V}$

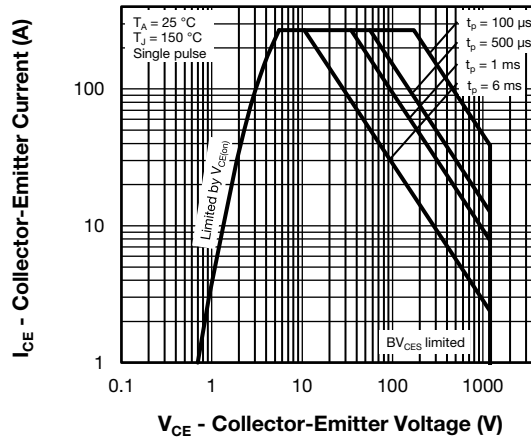

Fig. 17 - Trench IGBT Safe Operating Area

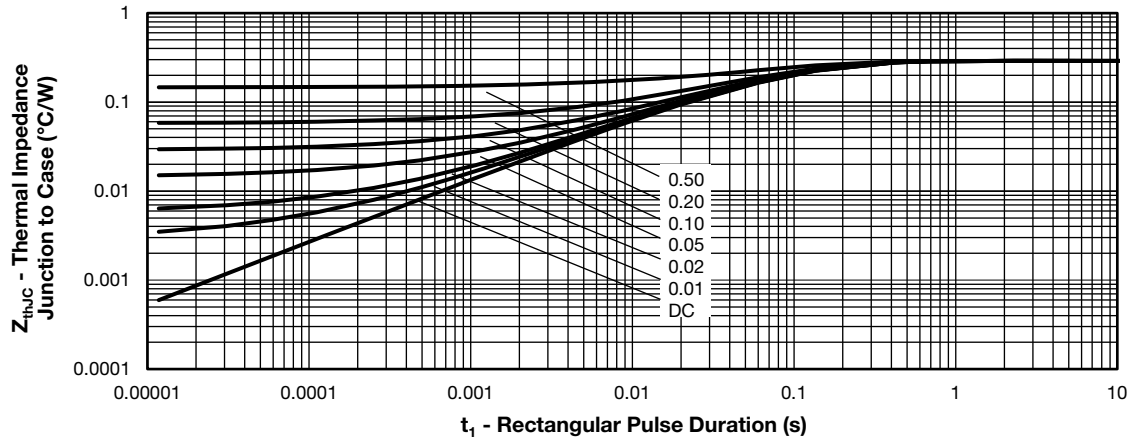

Fig. 18 - Maximum Trench IGBT Thermal Impedance  $Z_{thJC}$  Characteristics

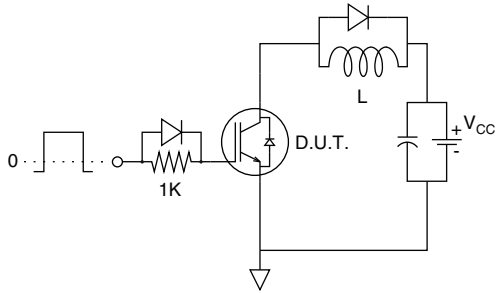

Fig. 19 - Gate Charge Circuit (Turn-Off)

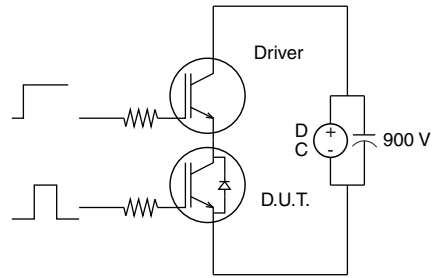

Fig. 21 - S.C. SOA Circuit

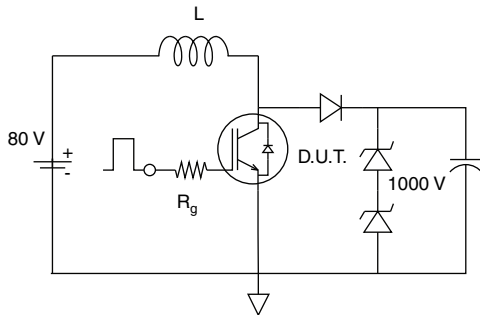

Fig. 20 - RBSOA Circuit

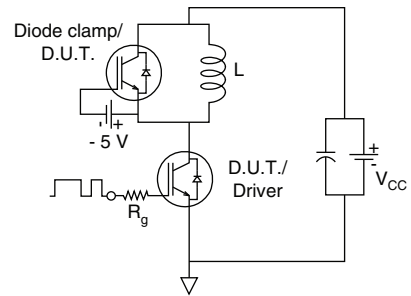

Fig. 22 - Switching Loss Circuit

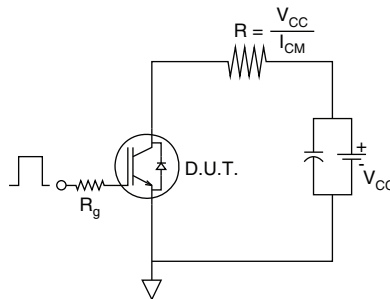

Fig. 23 - Resistive Load Circuit

## ORDERING INFORMATION TABLE

Device code	<b>VS-</b>	<b>G</b>	<b>T</b>	<b>75</b>	<b>Y</b>	<b>F</b>	<b>120</b>	<b>U</b>	<b>T</b>
	①	②	③	④	⑤	⑥	⑦	⑧	⑨

- 1** - Vishay Semiconductors product
- 2** - Insulated gate bipolar transistor (IGBT)
- 3** - T = Trench gate field stop IGBT
- 4** - Current rating (75 = 75 A)
- 5** - Circuit configuration (Y = 4 pack)
- 6** - Package indicator (F = ECONO 2)
- 7** - Voltage rating (120 = 1200 V)
- 8** - Speed/type (U = ultrafast IGBT)
- 9** - T = NTC thermistor

## CIRCUIT CONFIGURATION

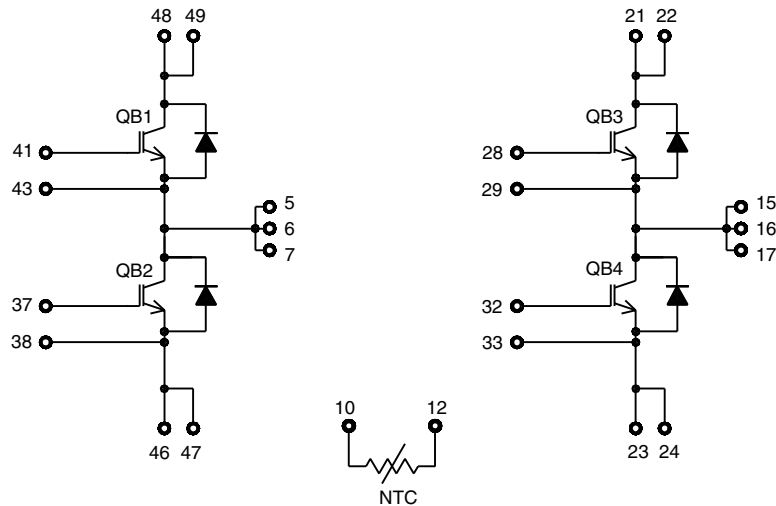





### DIMENSIONS in millimeters

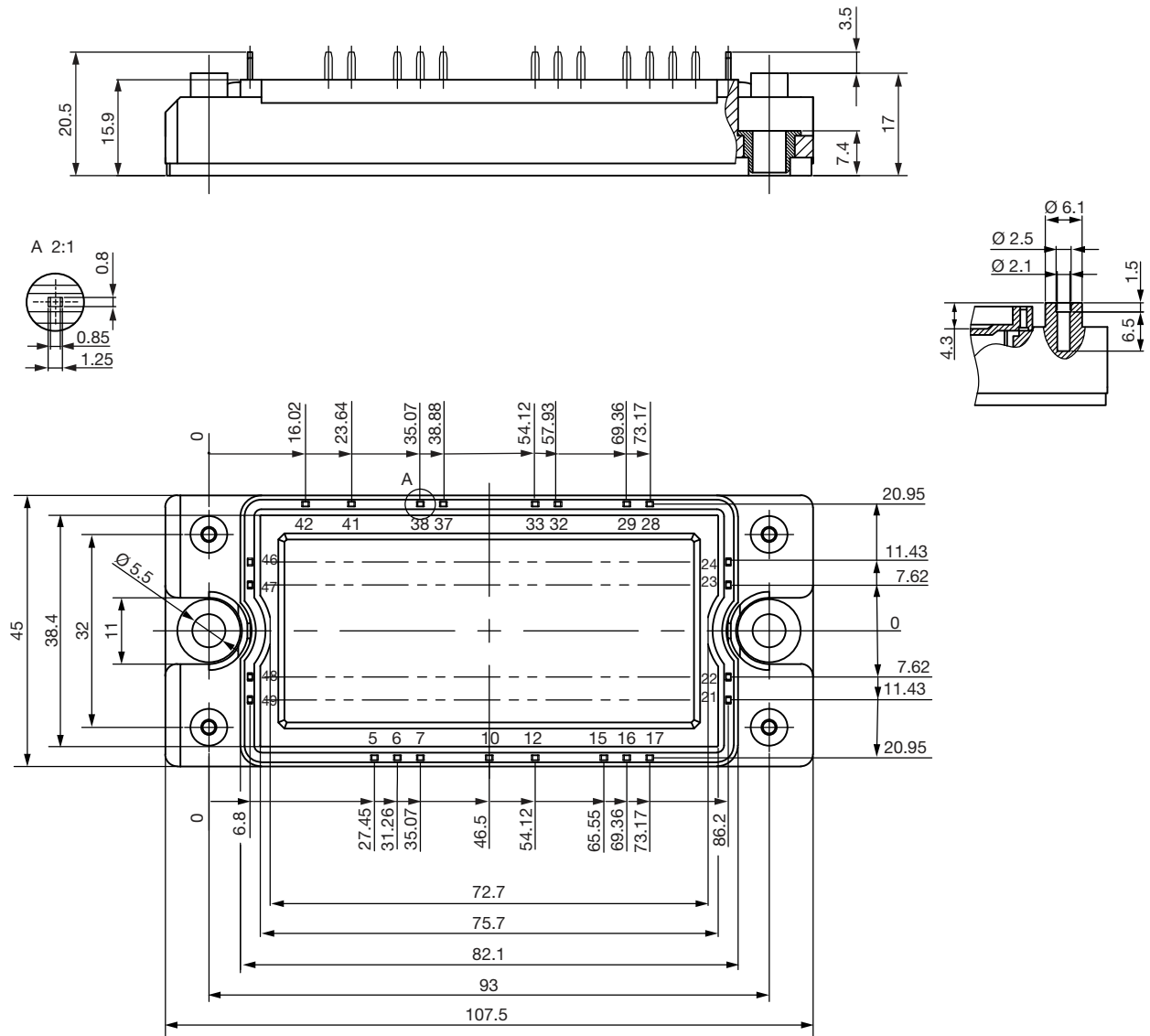



## Disclaimer

ALL PRODUCT, PRODUCT SPECIFICATIONS AND DATA ARE SUBJECT TO CHANGE WITHOUT NOTICE TO IMPROVE RELIABILITY, FUNCTION OR DESIGN OR OTHERWISE.

Vishay Intertechnology, Inc., its affiliates, agents, and employees, and all persons acting on its or their behalf (collectively, "Vishay"), disclaim any and all liability for any errors, inaccuracies or incompleteness contained in any datasheet or in any other disclosure relating to any product.

Vishay makes no warranty, representation or guarantee regarding the suitability of the products for any particular purpose or the continuing production of any product. To the maximum extent permitted by applicable law, Vishay disclaims (i) any and all liability arising out of the application or use of any product, (ii) any and all liability, including without limitation special, consequential or incidental damages, and (iii) any and all implied warranties, including warranties of fitness for particular purpose, non-infringement and merchantability.

Statements regarding the suitability of products for certain types of applications are based on Vishay's knowledge of typical requirements that are often placed on Vishay products in generic applications. Such statements are not binding statements about the suitability of products for a particular application. It is the customer's responsibility to validate that a particular product with the properties described in the product specification is suitable for use in a particular application. Parameters provided in datasheets and / or specifications may vary in different applications and performance may vary over time. All operating parameters, including typical parameters, must be validated for each customer application by the customer's technical experts. Product specifications do not expand or otherwise modify Vishay's terms and conditions of purchase, including but not limited to the warranty expressed therein.

Hyperlinks included in this datasheet may direct users to third-party websites. These links are provided as a convenience and for informational purposes only. Inclusion of these hyperlinks does not constitute an endorsement or an approval by Vishay of any of the products, services or opinions of the corporation, organization or individual associated with the third-party website. Vishay disclaims any and all liability and bears no responsibility for the accuracy, legality or content of the third-party website or for that of subsequent links.

Except as expressly indicated in writing, Vishay products are not designed for use in medical, life-saving, or life-sustaining applications or for any other application in which the failure of the Vishay product could result in personal injury or death. Customers using or selling Vishay products not expressly indicated for use in such applications do so at their own risk. Please contact authorized Vishay personnel to obtain written terms and conditions regarding products designed for such applications.

No license, express or implied, by estoppel or otherwise, to any intellectual property rights is granted by this document or by any conduct of Vishay. Product names and markings noted herein may be trademarks of their respective owners.