

CARRIER TAPE SPEC FOR SMT SINGLE VERTICAL HEADER OF NANO-FIT					
CARRIER TAPE NUMBER	DIM A	DIM B	DIM D	DIM E	DIM F
105431-8001	24.00	N/A	11.50	8.63	6.97
105431-8002	24.00	N/A	11.50	11.13	9.47
105431-8003	32.00	28.40	14.20	13.63	11.97
105431-8004	32.00	28.40	14.20	16.13	14.47
105431-8005	44.00	40.40	20.20	18.63	16.97
105431-8006	44.00	40.40	20.20	21.13	19.47
105431-8007	44.00	40.40	20.20	23.63	21.97

NOTES :  
1. REELING DIRECTION IN DELIVERY.

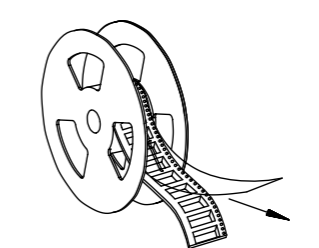

USER FEEDING DIRECTION



SECTION B-B

2. USER FEEDING DIRECTION

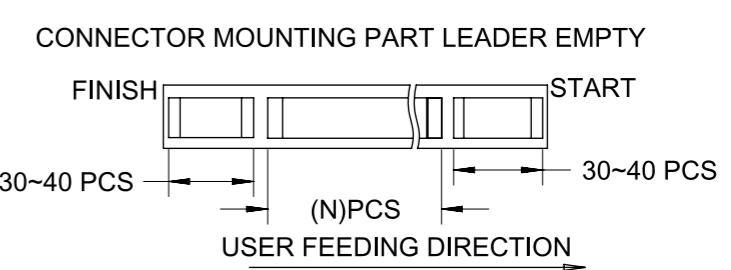

3. COVER TAPE PEELING FORCE

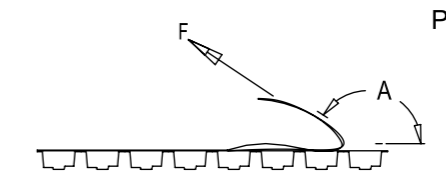

PEELING SPEED 300mm/Min.(REF.)

A	170°~180°
F	0.1N~1.3N

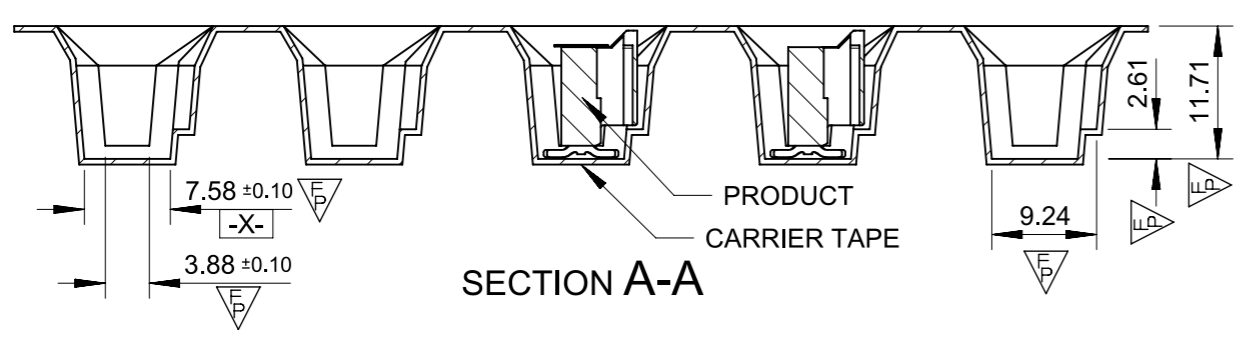

SECTION A-A

USER FEEDING DIRECTION

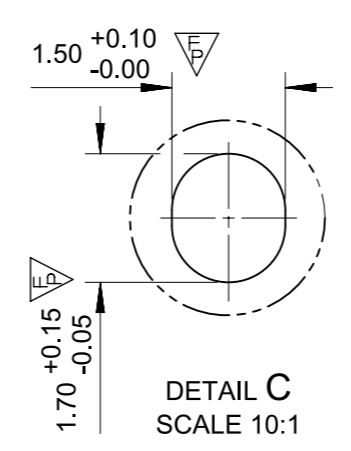

DETAIL C  
SCALE 10:1

NANO-FIT CONNECTOR FULLY LOADED

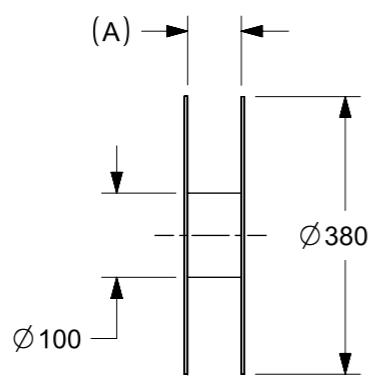
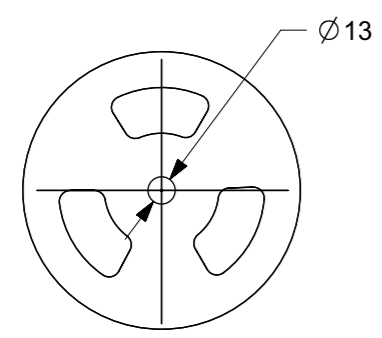
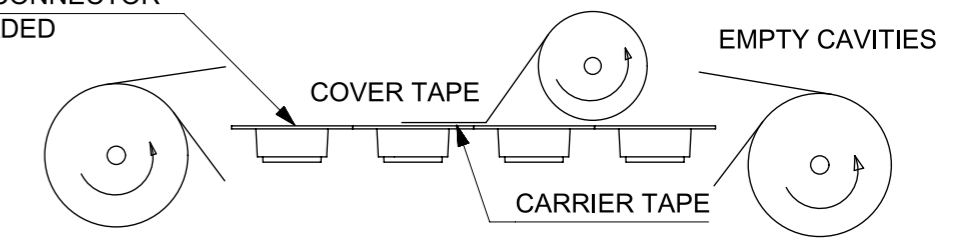

FUNCTIONAL SYMBOLS	THIS DRAWING CONTAINS INFORMATION THAT IS PROPRIETARY TO MOLEX ELECTRONIC TECHNOLOGIES, LLC AND SHOULD NOT BE USED WITHOUT WRITTEN PERMISSION		CURRENT REV DESC:	
▽A = 0	mm	SCALE	1:1	
▽E = 0	GENERAL TOLERANCES (UNLESS SPECIFIED)			
▽F = 0	ANGULAR TOL ± °			
4 PLACES	±			
3 PLACES	±			
2 PLACES	± 0.13			
1 PLACE	± 0.25			
0 PLACES	±			
DRAFT WHERE APPLICABLE MUST REMAIN WITHIN DIMENSIONS	THIRD ANGLE PROJECTION	DRAWING	SERIES	MATERIAL NUMBER
		A3-SIZE	105431	
EC NO: 670810		2021/07/21		molex
DRWN: GLLI		2021/07/22		
CHK'D: YXZHENG		2021/07/22		PACKING DRAWING FOR NANO-FIT
APPR: YXZHENG		2021/07/22		
INITIAL REVISION:		2021/07/21		PRODUCT CUSTOMER DRAWING
DRWN: GLLI		2021/07/22		
APPR: YXZHENG		2021/07/22		DOCUMENT NUMBER
				1054311000-PK
				DOC TYPE
				PSD
				DOC PART
				000
				REVISION
				A
				CUSTOMER
				GENERAL MARKET
				SHEET NUMBER
				1 OF 2

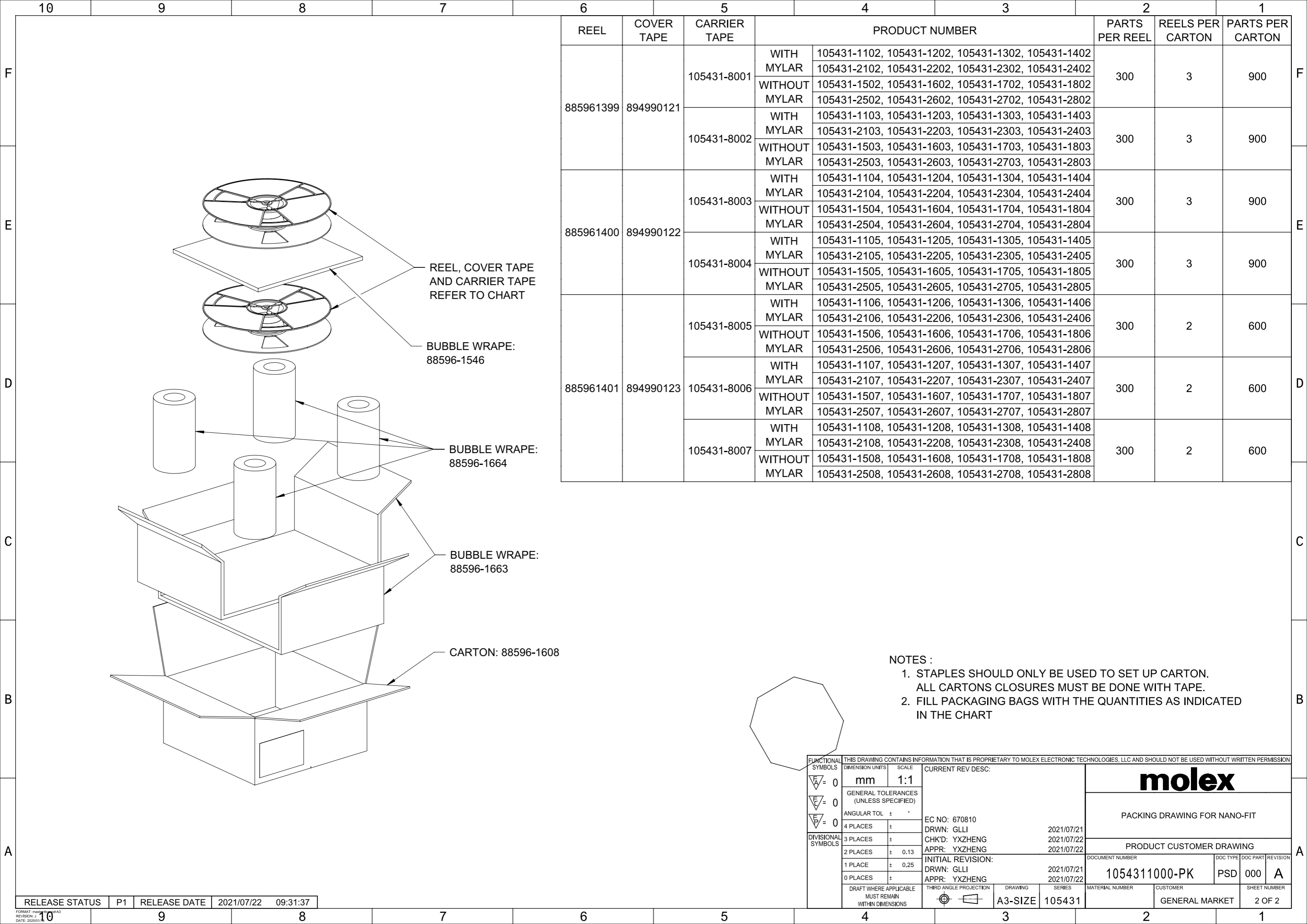

REEL	COVER TAPE	CARRIER TAPE	PRODUCT NUMBER		PARTS PER REEL	REELS PER CARTON	PARTS PER CARTON				
885961399	894990121	105431-8001	WITH MYLAR	105431-1102, 105431-1202, 105431-1302, 105431-1402	300	3	900				
			WITHOUT MYLAR	105431-1502, 105431-1602, 105431-1702, 105431-1802							
			WITHOUT MYLAR	105431-2502, 105431-2602, 105431-2702, 105431-2802							
		105431-8002	WITH MYLAR	105431-1103, 105431-1203, 105431-1303, 105431-1403				300	3	900	
			WITHOUT MYLAR	105431-1503, 105431-1603, 105431-1703, 105431-1803							
			WITHOUT MYLAR	105431-2503, 105431-2603, 105431-2703, 105431-2803							
885961400	894990122	105431-8003	WITH MYLAR	105431-1104, 105431-1204, 105431-1304, 105431-1404	300	3	900				
			WITHOUT MYLAR	105431-1504, 105431-1604, 105431-1704, 105431-1804							
			WITHOUT MYLAR	105431-2504, 105431-2604, 105431-2704, 105431-2804							
		105431-8004	WITH MYLAR	105431-1105, 105431-1205, 105431-1305, 105431-1405				300	3	900	
			WITHOUT MYLAR	105431-1505, 105431-1605, 105431-1705, 105431-1805							
			WITHOUT MYLAR	105431-2505, 105431-2605, 105431-2705, 105431-2805							
885961401	894990123	105431-8005	WITH MYLAR	105431-1106, 105431-1206, 105431-1306, 105431-1406	300	2	600				
			WITHOUT MYLAR	105431-1506, 105431-1606, 105431-1706, 105431-1806							
			WITHOUT MYLAR	105431-2506, 105431-2606, 105431-2706, 105431-2806							
			105431-8006	WITH MYLAR				105431-1107, 105431-1207, 105431-1307, 105431-1407	300	2	600
				WITHOUT MYLAR				105431-1507, 105431-1607, 105431-1707, 105431-1807			
				WITHOUT MYLAR				105431-2507, 105431-2607, 105431-2707, 105431-2807			
		105431-8007	WITH MYLAR	105431-1108, 105431-1208, 105431-1308, 105431-1408	300	2	600				
			WITHOUT MYLAR	105431-1508, 105431-1608, 105431-1708, 105431-1808							
			WITHOUT MYLAR	105431-2508, 105431-2608, 105431-2708, 105431-2808							

- NOTES :
1. STAPLES SHOULD ONLY BE USED TO SET UP CARTON. ALL CARTONS CLOSURES MUST BE DONE WITH TAPE.
  2. FILL PACKAGING BAGS WITH THE QUANTITIES AS INDICATED IN THE CHART



FUNCTIONAL SYMBOLS		THIS DRAWING CONTAINS INFORMATION THAT IS PROPRIETARY TO MOLEX ELECTRONIC TECHNOLOGIES, LLC AND SHOULD NOT BE USED WITHOUT WRITTEN PERMISSION		CURRENT REV DESC:		<b>molex</b>	
▽/A = 0	mm	SCALE	1:1	EC NO: 670810			
▽/E = 0	GENERAL TOLERANCES (UNLESS SPECIFIED)		DRWN: GLLI		2021/07/21	PACKING DRAWING FOR NANO-FIT	
▽/P = 0	ANGULAR TOL ± °		CHK'D: YXZHENG		2021/07/22	PRODUCT CUSTOMER DRAWING	
DIVISIONAL SYMBOLS		4 PLACES ±	APPR: YXZHENG		2021/07/22	DOCUMENT NUMBER	
		3 PLACES ±	INITIAL REVISION:		2021/07/21	1054311000-PK	DOC TYPE
		2 PLACES ± 0.13	DRWN: GLLI		2021/07/21	PSD	DOC PART
		1 PLACE ± 0.25	APPR: YXZHENG		2021/07/22	000	REVISION
		0 PLACES ±	DRAFT WHERE APPLICABLE MUST REMAIN WITHIN DIMENSIONS			A	
		THIRD ANGLE PROJECTION		DRAWING	SERIES	MATERIAL NUMBER	CUSTOMER
		A3-SIZE		105431		GENERAL MARKET	SHEET NUMBER
							2 OF 2



RECOMMENDED PCB LAYOUT(CONNECTOR SIDE VIEW)  
THICKNESS=1.60mm MIN. TOLERANCE:±0.05



WITHOUT MYLAR

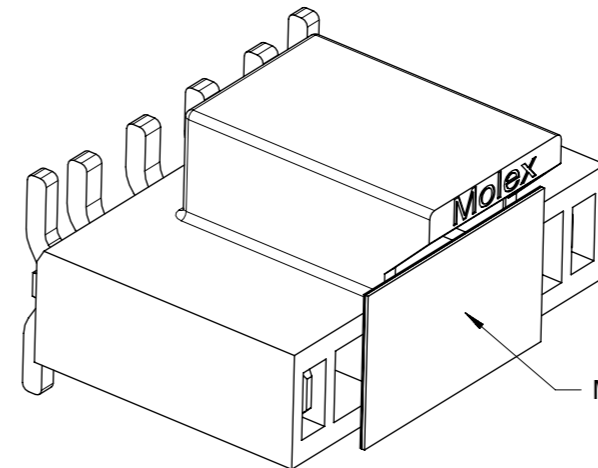

WITH MYLAR

THIS DRAWING CONTAINS INFORMATION THAT IS PROPRIETARY TO MOLEX ELECTRONIC TECHNOLOGIES, LLC AND SHOULD NOT BE USED WITHOUT WRITTEN PERMISSION												
QUALITY SYMBOLS		EC NO: 670810 DRWN: GLLI CHK'D: YXZHENG APPR: YXZHENG			GENERAL TOLERANCES (UNLESS SPECIFIED) ANGULAR TOL ± 3.0 ° 4 PLACES ± 3 PLACES ± 2 PLACES ± 0.2 1 PLACE ± 0.3 0 PLACES ±		DIMENSION UNITS: mm SCALE: 5:1 DRWN BY: WJHUO DATE: 2014/10/30 CHK'D BY: DATE: APPR BY: AYIN DATE: 2015/03/12					
▽ = 0 ▽ = 0 ▽ = 0 ▼ = 0 ▽ = 0 ⊗ = 0 ■ = 0 ▽ = 0		DRAFT WHERE APPLICABLE MUST REMAIN WITHIN DIMENSIONS			DRAFTING SIZE: A3 THIRD ANGLE PROJECTION		SD DRAWING FOR NANO-FIT HEADER OF SMT VERTICAL SINGLE CONN.			PRODUCT CUSTOMER DRAWING		
RELEASE STATUS: P1 RELEASE DATE: 2021/07/22 09:31:37		D1		DRAWING SIZE: A3		SERIES: 105431 MATERIAL NUMBER: SEE TABLE CUSTOMER: GENERAL MARKET		DOCUMENT NUMBER: SD-105431-001 DOC TYPE: PSD DOC PART: 000 SHEET NUMBER: 1 OF 4				



9		8			7		6		5		4		3			2		1	
PART NUMBER (WITH MYLAR)	PART NUMBER (WITHOUT MYLAR)	DIM. A	DIM. B	DIM. C	CKT SIZE	PLATING	LUBE					PART NUMBER (WITH MYLAR)	PART NUMBER (WITHOUT MYLAR)	DIM. A	DIM. B	DIM. C	CKT SIZE	PLATING	LUBE
105431-1102	105431-1502	8.23	2.50	6.11	2	TIN						105431-2102	105431-2502	8.23	2.50	6.11	2	TIN	
105431-1103	105431-1503	10.73	5.00	8.61	3							105431-2103	105431-2503	10.73	5.00	8.61	3		
105431-1104	105431-1504	13.23	7.50	11.11	4							105431-2104	105431-2504	13.23	7.50	11.11	4		
105431-1105	105431-1505	15.73	10.00	13.61	5							105431-2105	105431-2505	15.73	10.00	13.61	5		
105431-1106	105431-1506	18.23	12.50	16.11	6							105431-2106	105431-2506	18.23	12.50	16.11	6		
105431-1107	105431-1507	20.73	15.00	18.61	7							105431-2107	105431-2507	20.73	15.00	18.61	7		
105431-1108	105431-1508	23.23	17.50	21.11	8							105431-2108	105431-2508	23.23	17.50	21.11	8		
105431-1202	105431-1602	8.23	2.50	6.11	2			GOLD 0.38	NO					105431-2202	105431-2602	8.23	2.50		
105431-1203	105431-1603	10.73	5.00	8.61	3							105431-2203	105431-2603	10.73	5.00	8.61	3		
105431-1204	105431-1604	13.23	7.50	11.11	4							105431-2204	105431-2604	13.23	7.50	11.11	4		
105431-1205	105431-1605	15.73	10.00	13.61	5							105431-2205	105431-2605	15.73	10.00	13.61	5		
105431-1206	105431-1606	18.23	12.50	16.11	6							105431-2206	105431-2606	18.23	12.50	16.11	6		
105431-1207	105431-1607	20.73	15.00	18.61	7							105431-2207	105431-2607	20.73	15.00	18.61	7		
105431-1208	105431-1608	23.23	17.50	21.11	8							105431-2208	105431-2608	23.23	17.50	21.11	8		
105431-1302	105431-1702	8.23	2.50	6.11	2	GOLD 0.76								105431-2302	105431-2702	8.23	2.50	6.11	2
105431-1303	105431-1703	10.73	5.00	8.61	3							105431-2303	105431-2703	10.73	5.00	8.61	3		
105431-1304	105431-1704	13.23	7.50	11.11	4							105431-2304	105431-2704	13.23	7.50	11.11	4		
105431-1305	105431-1705	15.73	10.00	13.61	5							105431-2305	105431-2705	15.73	10.00	13.61	5		
105431-1306	105431-1706	18.23	12.50	16.11	6							105431-2306	105431-2706	18.23	12.50	16.11	6		
105431-1307	105431-1707	20.73	15.00	18.61	7							105431-2307	105431-2707	20.73	15.00	18.61	7		
105431-1308	105431-1708	23.23	17.50	21.11	8							105431-2308	105431-2708	23.23	17.50	21.11	8		
105431-1402	105431-1802	8.23	2.50	6.11	2			GOLD 0.76	YES					105431-2402	105431-2802	8.23	2.50	6.11	2
105431-1403	105431-1803	10.73	5.00	8.61	3							105431-2403	105431-2803	10.73	5.00	8.61	3		
105431-1404	105431-1804	13.23	7.50	11.11	4							105431-2404	105431-2804	13.23	7.50	11.11	4		
105431-1405	105431-1805	15.73	10.00	13.61	5							105431-2405	105431-2805	15.73	10.00	13.61	5		
105431-1406	105431-1806	18.23	12.50	16.11	6							105431-2406	105431-2806	18.23	12.50	16.11	6		
105431-1407	105431-1807	20.73	15.00	18.61	7							105431-2407	105431-2807	20.73	15.00	18.61	7		
105431-1408	105431-1808	23.23	17.50	21.11	8							105431-2408	105431-2808	23.23	17.50	21.11	8		
		COLOR: BLACK										COLOR: NATURAL							

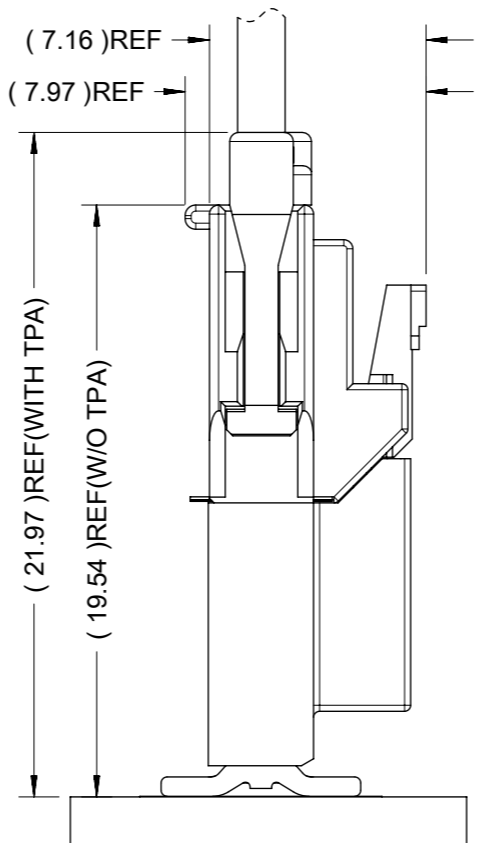

**NOTES FOR ALL PARTS**







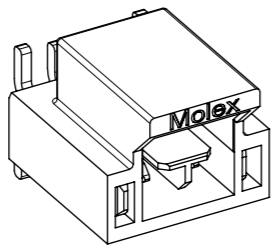
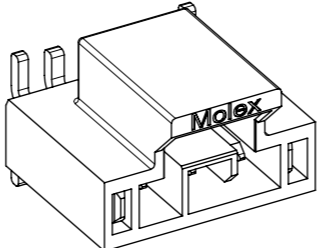
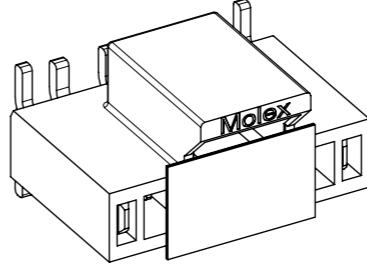
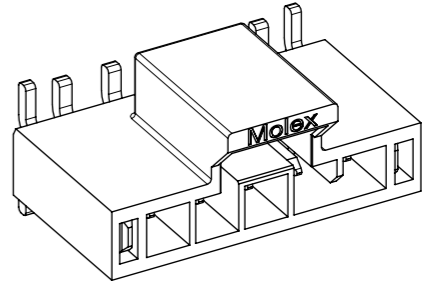
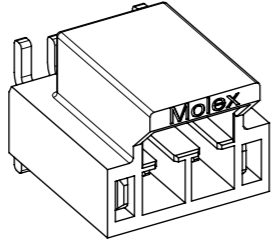
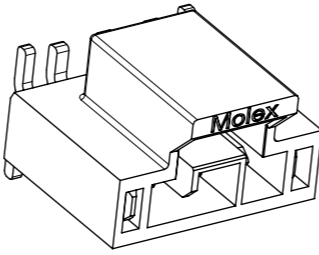
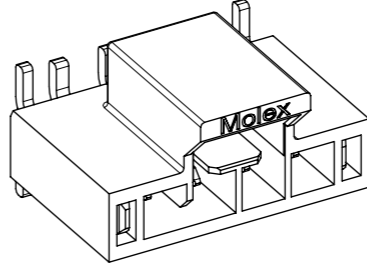
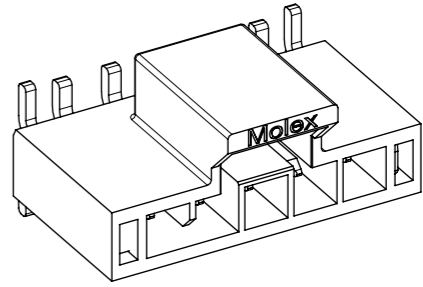
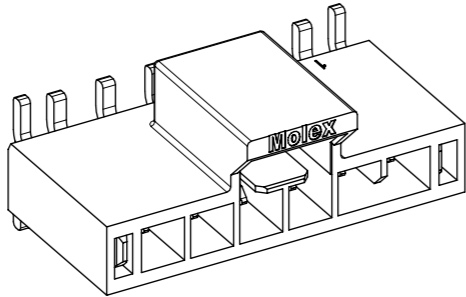
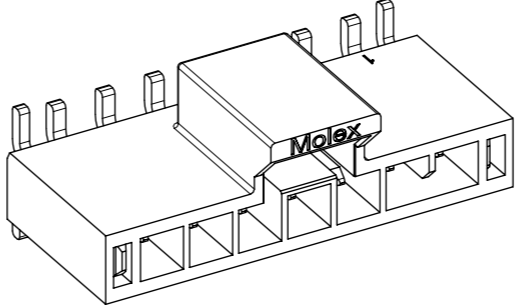
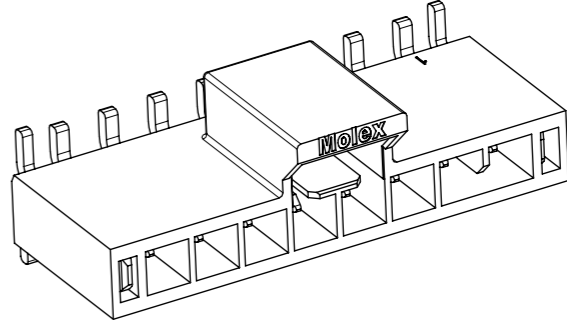
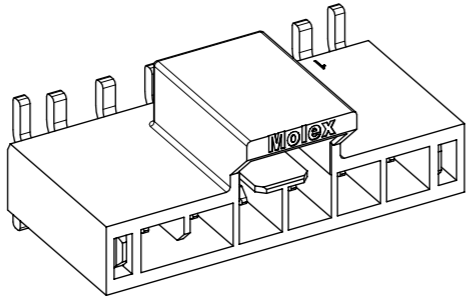
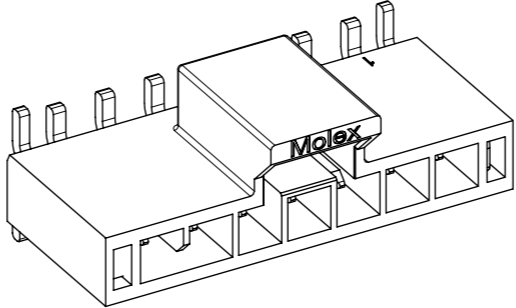
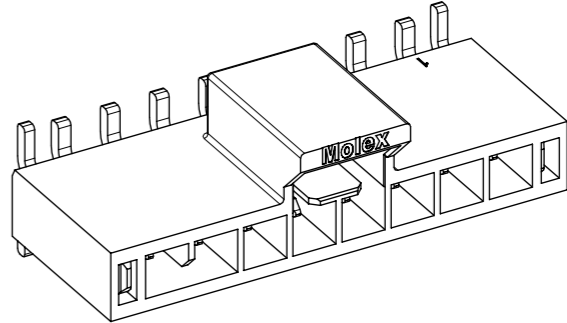

1> MATERIAL:  
HOUSING: LCP, UL 94V-0.  
TERMINAL: BRASS.  
SOLDER CLIP: BRASS.

2> PLATING FINISHED:  
TERMINAL:  
CONTACT AREA:  
a. REFLOWED MATTE TIN 0.76 MICRONS MIN; b. GOLD 0.38 MICRONS MIN; c. GOLD 0.76 MICRONS MIN.  
SOLDER AREA: TIN 0.76 MICRONS MINIMUM.  
UNDER PLATING NICKEL 1.25 MICRONS MINIMUM.  
SOLDER CLIP: TIN 2.5 MICRONS MINIMUM; UNDER PLATING NICKEL 1.25 MICRONS MINIMUM.

3> PRODUCT SPECIFICATION: PS-105405-001.  
4> PACKAGE: TAPE REEL, DETAILS REFER TO DRAWING 1054311000-PK.  
5> ALL COMPONENTS AND PRODUCT COMPLIANT TO RoHS DIRECTIVE 2011/65/EU AND ELV DIRECTIVE 2000/53/EC.  
6> PRODUCT MATE WITH SERIES OF 105307(RECEPTACLE), 105300(CRIMP TERMINAL).  
7> PARTS CONFORM TO CLASS 'B' REQUIREMENTS OF COSMETIC SPECIFICATION PS-45499-002.

<table border="1"> <tr><th>QUALITY SYMBOLS</th><th>THIS DRAWING CONTAINS INFORMATION THAT IS PROPRIETARY TO MOLEX ELECTRONIC TECHNOLOGIES, LLC AND SHOULD NOT BE USED WITHOUT WRITTEN PERMISSION</th></tr> <tr><td>▽A = 0</td><td rowspan="10">           EC NO: 670810            DRWN: GLLI            CHK'D: YXZHENG            APPR: YXZHENG            DATE: 2015/11/16         </td></tr> <tr><td>▽E = 0</td></tr> <tr><td>▽B = 0</td></tr> <tr><td>▽ = 0</td></tr> <tr><td>▽C = 0</td></tr> <tr><td>▽ = 0</td></tr> <tr><td>▽ = 0</td></tr> <tr><td>▽ = 0</td></tr> <tr><td>▽ = 0</td></tr> <tr><td>▽ = 0</td></tr> </table>										QUALITY SYMBOLS	THIS DRAWING CONTAINS INFORMATION THAT IS PROPRIETARY TO MOLEX ELECTRONIC TECHNOLOGIES, LLC AND SHOULD NOT BE USED WITHOUT WRITTEN PERMISSION	▽A = 0	EC NO: 670810 DRWN: GLLI CHK'D: YXZHENG APPR: YXZHENG DATE: 2015/11/16	▽E = 0	▽B = 0	▽ = 0	▽C = 0	▽ = 0	▽ = 0	▽ = 0	▽ = 0	▽ = 0	<table border="1"> <tr><th colspan="2">GENERAL TOLERANCES (UNLESS SPECIFIED)</th></tr> <tr><td>ANGULAR TOL ± 3.0 °</td></tr> <tr><td>4 PLACES ±</td></tr> <tr><td>3 PLACES ±</td></tr> <tr><td>2 PLACES ± 0.2</td></tr> <tr><td>1 PLACE ± 0.3</td></tr> <tr><td>0 PLACES ±</td></tr> <tr><td>DRAFT WHERE APPLICABLE MUST REMAIN WITHIN DIMENSIONS</td></tr> </table>		GENERAL TOLERANCES (UNLESS SPECIFIED)		ANGULAR TOL ± 3.0 °	4 PLACES ±	3 PLACES ±	2 PLACES ± 0.2	1 PLACE ± 0.3	0 PLACES ±	DRAFT WHERE APPLICABLE MUST REMAIN WITHIN DIMENSIONS	<table border="1"> <tr><th>DIMENSION UNITS</th><th>SCALE</th></tr> <tr><td>mm</td><td>5:1</td></tr> <tr><th>DRWN BY</th><th>DATE</th></tr> <tr><td>WJHUO</td><td>2014/10/30</td></tr> <tr><th>CHK'D BY</th><th>DATE</th></tr> <tr><td></td><td></td></tr> <tr><th>APPR BY</th><th>DATE</th></tr> <tr><td>AYIN</td><td>2015/03/12</td></tr> <tr><th>DRAWING SIZE</th><th>THIRD ANGLE PROJECTION</th></tr> <tr><td>A3</td><td></td></tr> </table>		DIMENSION UNITS	SCALE	mm	5:1	DRWN BY	DATE	WJHUO	2014/10/30	CHK'D BY	DATE			APPR BY	DATE	AYIN	2015/03/12	DRAWING SIZE	THIRD ANGLE PROJECTION	A3		<table border="1"> <tr><th colspan="4">molex</th></tr> <tr><td colspan="4" style="text-align: center;">SD DRAWING FOR NANO-FIT HEADER OF SMT VERTICAL SINGLE CONN.</td></tr> <tr><th colspan="4">PRODUCT CUSTOMER DRAWING</th></tr> <tr><th>SERIES</th><th>MATERIAL NUMBER</th><th colspan="2">CUSTOMER</th></tr> <tr><td>105431</td><td>SEE TABLE</td><td colspan="2">GENERAL MARKET</td></tr> <tr><th colspan="2">DOCUMENT NUMBER</th><th>DOC TYPE</th><th>DOC PART</th><th>SHEET NUMBER</th></tr> <tr><td colspan="2">SD-105431-001</td><td>PSD</td><td>000</td><td>3 OF 4</td></tr> </table>				molex				SD DRAWING FOR NANO-FIT HEADER OF SMT VERTICAL SINGLE CONN.				PRODUCT CUSTOMER DRAWING				SERIES	MATERIAL NUMBER	CUSTOMER		105431	SEE TABLE	GENERAL MARKET		DOCUMENT NUMBER		DOC TYPE	DOC PART	SHEET NUMBER	SD-105431-001		PSD	000	3 OF 4
QUALITY SYMBOLS	THIS DRAWING CONTAINS INFORMATION THAT IS PROPRIETARY TO MOLEX ELECTRONIC TECHNOLOGIES, LLC AND SHOULD NOT BE USED WITHOUT WRITTEN PERMISSION																																																																																								
▽A = 0	EC NO: 670810 DRWN: GLLI CHK'D: YXZHENG APPR: YXZHENG DATE: 2015/11/16																																																																																								
▽E = 0																																																																																									
▽B = 0																																																																																									
▽ = 0																																																																																									
▽C = 0																																																																																									
▽ = 0																																																																																									
▽ = 0																																																																																									
▽ = 0																																																																																									
▽ = 0																																																																																									
▽ = 0																																																																																									
GENERAL TOLERANCES (UNLESS SPECIFIED)																																																																																									
ANGULAR TOL ± 3.0 °																																																																																									
4 PLACES ±																																																																																									
3 PLACES ±																																																																																									
2 PLACES ± 0.2																																																																																									
1 PLACE ± 0.3																																																																																									
0 PLACES ±																																																																																									
DRAFT WHERE APPLICABLE MUST REMAIN WITHIN DIMENSIONS																																																																																									
DIMENSION UNITS	SCALE																																																																																								
mm	5:1																																																																																								
DRWN BY	DATE																																																																																								
WJHUO	2014/10/30																																																																																								
CHK'D BY	DATE																																																																																								
APPR BY	DATE																																																																																								
AYIN	2015/03/12																																																																																								
DRAWING SIZE	THIRD ANGLE PROJECTION																																																																																								
A3																																																																																									
molex																																																																																									
SD DRAWING FOR NANO-FIT HEADER OF SMT VERTICAL SINGLE CONN.																																																																																									
PRODUCT CUSTOMER DRAWING																																																																																									
SERIES	MATERIAL NUMBER	CUSTOMER																																																																																							
105431	SEE TABLE	GENERAL MARKET																																																																																							
DOCUMENT NUMBER		DOC TYPE	DOC PART	SHEET NUMBER																																																																																					
SD-105431-001		PSD	000	3 OF 4																																																																																					
RELEASE STATUS	P1	RELEASE DATE	2021/07/22	09:31:37																																																																																					

	2 CKT	3 CKT	4 CKT	5 CKT
BLACK				
NATURAL				
	6 CKT	7 CKT	8 CKT	
BLACK				
NATURAL				

THIS DRAWING CONTAINS INFORMATION THAT IS PROPRIETARY TO MOLEX ELECTRONIC TECHNOLOGIES, LLC AND SHOULD NOT BE USED WITHOUT WRITTEN PERMISSION													
<b>QUALITY SYMBOLS</b>  = 0  = 0  = 0  = 0  = 0  = 0  = 0  = 0		EC NO: 670810 DRWN: GLLI CHK'D: YXZHENG APPR: YXZHENG		2021/04/27 2021/07/22 2021/07/22		<b>GENERAL TOLERANCES (UNLESS SPECIFIED)</b> ANGULAR TOL ± 3.0 ° 4 PLACES ± 3 PLACES ± 2 PLACES ± 0.2 1 PLACE ± 0.3 0 PLACES ±		DRAFT WHERE APPLICABLE MUST REMAIN WITHIN DIMENSIONS		DIMENSION UNITS: mm SCALE: 3:1 DRWN BY: RMV02 DATE: 2016/01/14 CHK'D BY: DATE: APPR BY: AYIN DATE: 2017/05/15		 SD DRAWING FOR NANO-FIT HEADER OF SMT VERTICAL SINGLE CONN.	
PRODUCT CUSTOMER DRAWING		SERIES: 105431 MATERIAL NUMBER: CUSTOMER: GENERAL MARKET		DOCUMENT NUMBER: SD-105431-001 DOC TYPE: PSD DOC PART: 000 SHEET NUMBER: 4 OF 4									