

Data sheet | Item number: 870-523/281-592

Component terminal block; double-deck; with suppressor diode; 110 VDC;
for DIN-rail 35 x 15 and 35 x 7.5; 2.5 mm²; CAGE CLAMP®; 2,50 mm²; gray

www.wago.com/870-523/281-592

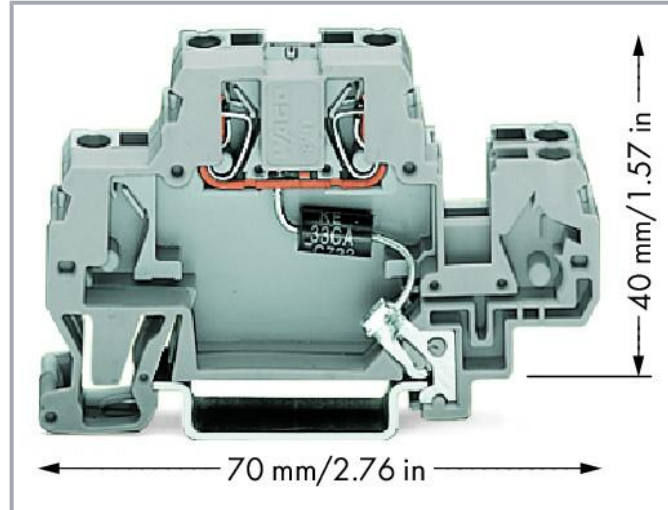
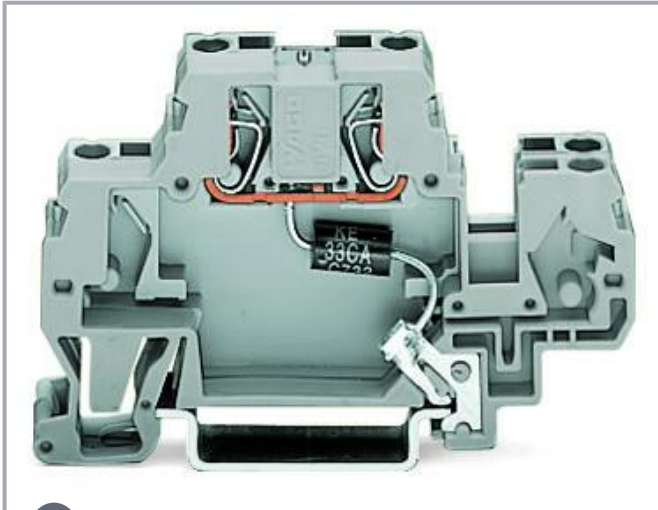

i Picture differs from the item.

Color: —

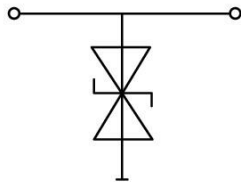

Data

Electrical data

Nominal operating voltage	DC 110 V
Highest continuous voltage	DC 128 V
Rated continuous current	20 A
Nominal discharge current (8/20 μs) (line)	38 A
Protection level (8/20 μs)	≤ DC 265 V
Capacitance	≤ 850 pF

Subject to changes. Please also observe the further product documentation!

WAGO GmbH & Co. KG
Hansastr. 27
32423 Minden
Phone: +49571 887-0 | Fax: +49571 887-169
Email: info.de@wago.com | Web: www.wago.com

Do you have any questions about our products?
We are always happy to take your call at +49 (571) 887-44222.

Connection data

Connections (number)	2
Connection technology	CAGE CLAMP®
Solid conductor	0.08 ... 2.5 mm ² / 28 ... 14 AWG
Fine-stranded conductor	0.08 ... 4 mm ² / 28 ... 12 AWG
Fine-stranded conductor; with insulated ferrule	0.08 ... 1.5 mm ² / 28 ... 14 AWG
Strip length	6 ... 7 mm / 0.24 ... 0.28 inches

Physical data

Width	10 mm / 0.394 inches
Height from upper-edge of DIN-rail	40 mm / 1.575 inches
Depth	70 mm / 2.756 inches

Mechanical Data

Mounting type	DIN-35 rail
---------------	-------------

Material Data

Color	gray
Insulation material	Polyamide (PA66)
Material group	I
Flammability class per UL94	V0
Fire load	0.257 MJ
Weight	11.8 g

Environmental requirements

Processing temperature	-35 ... +85 °C
------------------------	----------------

Commercial data

Product Group	16 (Rail Mounted Terminal Blocks with CCC)
eCl@ss 10.0	27-14-11-27
eCl@ss 9.0	27-14-11-27
ETIM 8.0	EC000903
ETIM 7.0	EC000903
PU (SPU)	25 pcs
Packaging type	box

Subject to changes. Please also observe the further product documentation!

Country of origin	DE
GTIN	4017332553780
Customs tariff number	85369010000

Environmental Product Compliance

RoHS Compliance Status	Compliant,With Exemption
RoHS Exemption	7(a) 7(c)-I 7(c)-II
SCIP notification number (Bulgaria)	f1578734-bbfa-4959-9b16-d8b8e95eb30e
SCIP notification number (Czech Republic)	d17e89bf-f4c7-4188-8382-f60a26c62c15

Optional accessories



Jumpers

Jumper		
	Item no.: 280-492 Jumper; 2-way; insulated; gray	www.wago.com/280-492



Tool

Operating tool		
	Item no.: 210-720 Operating tool; Blade: 3.5 x 0.5 mm; with a partially insulated shaft; multicoloured	www.wago.com/210-720

Marking accessories

Marker		
	Item no.: 2009-145 Mini-WSB Inline; for Smart Printer; 1700 pieces on roll; stretchable 5 - 5.2 mm; plain; snap-on type; white	www.wago.com/2009-145
	Item no.: 248-501 Mini-WSB marking card; as card; not stretchable; plain; snap-on type; white	www.wago.com/248-501

Insulation stop

Insulation stop		
	Item no.: 280-472 Insulation stop; 0.75 - 1 mm ² ; 5 pieces/strip; black	www.wago.com/280-472
	Item no.: 280-470 Insulation stop; 0.08 - 0.2 mm ² "s" (0.14 mm ² "f-st"); 5 pieces/strip; white	www.wago.com/280-470

Subject to changes. Please also observe the further product documentation!



Item no.: 280-471
Insulation stop; 0.25 - 0.5 mm²; 5 pieces/strip; light gray

www.wago.com/280-471

End plate

End plate



Item no.: 870-518
End and intermediate plate; 2 mm thick; gray

www.wago.com/870-518



Item no.: 870-519
End and intermediate plate; 2 mm thick; orange

www.wago.com/870-519

Downloads

Documentation

Bid Text

870-523/281-592 X81 - Datei	2019 Feb 19	xml 3.4 kB	Download
--------------------------------	-------------	---------------	----------

870-523/281-592 doc - Datei	2015 Feb 11	doc 25.6 kB	Download
--------------------------------	-------------	----------------	----------

Additional Information

Disposal and Recycling Electrical and electronic equipment, Batteries, Packaging	V 1.1.0 2022 Aug 18	pdf 2.2 MB	Download
---	------------------------	---------------	----------

CAD/CAE-Data

CAD data

2D/3D Models 870-523/281-592	URL	Download
------------------------------	-----	----------

CAE data

EPLAN Data Portal 870-523/281-592	URL	Download
-----------------------------------	-----	----------

WSCAD Universe 870-523/281-592	URL	Download
--------------------------------	-----	----------

ZUKEN Portal 870-523/281-592	URL	Download
------------------------------	-----	----------

EPLAN Data Portal 870-523/281-592	URL	Download
-----------------------------------	-----	----------

WSCAD Universe 870-523/281-592

Subject to changes. Please also observe the further product documentation!

WAGO GmbH & Co. KG
Hansastr. 27
32423 Minden
Phone: +49571 887-0 | Fax: +49571 887-169
Email: info.de@wago.com | Web: www.wago.com

Do you have any questions about our products?
We are always happy to take your call at +49 (571) 887-44222.



[URL](#)

[Download](#)

Environmental Product Compliance

Compliance Search

Environmental Product Compliance 870-523/281-592

[URL](#)

[Download](#)

Component terminal block; double-deck; with suppressor diode; 110 VDC; for DIN-rail 35 x 15 and 35 x 7.5; 2.5 mm²; CAGE CLAMP®; 2,50 mm²; gray

Installation Notes

Subject to changes. Please also observe the further product documentation!

WAGO GmbH & Co. KG

Hansastr. 27

32423 Minden

Phone: +49571 887-0 | Fax: +49571 887-169

Email: info.de@wago.com | Web: www.wago.com

Do you have any questions about our products?

We are always happy to take your call at +49 (571) 887-44222.