

SAGA-HB-IP-WHT

~60° high bay beam

SPECIFICATION:

Dimensions	Ø 50.0 mm
Height	12 mm
Fastening	screw
Ingress protection classes	IP67
ROHS compliant	yes ⓘ

MATERIALS:

Component	Type	Material	Colour	Finish
C13586_SAGA-HB-IP	Single lens	Silicone	clear	
C13591_SAGA-FRAME-WHT	Holder	HRCPC	white	

ORDERING INFORMATION:

Quantities for one set:

Single lens	1
Holder	1

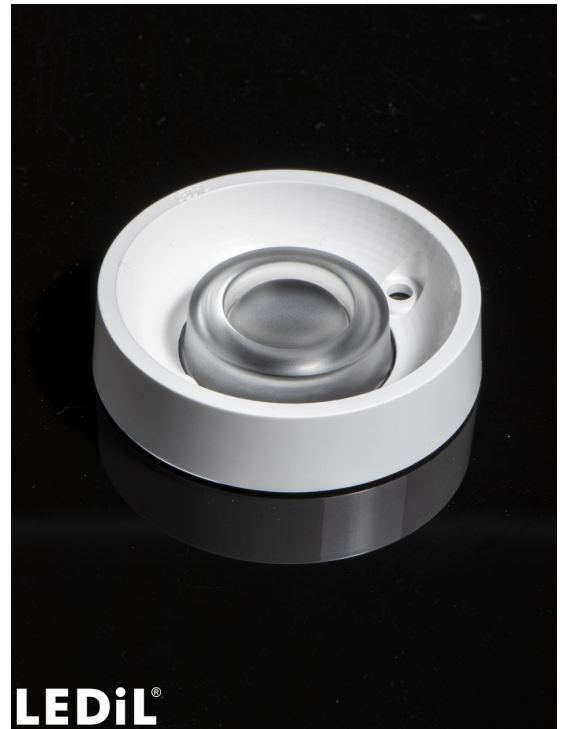



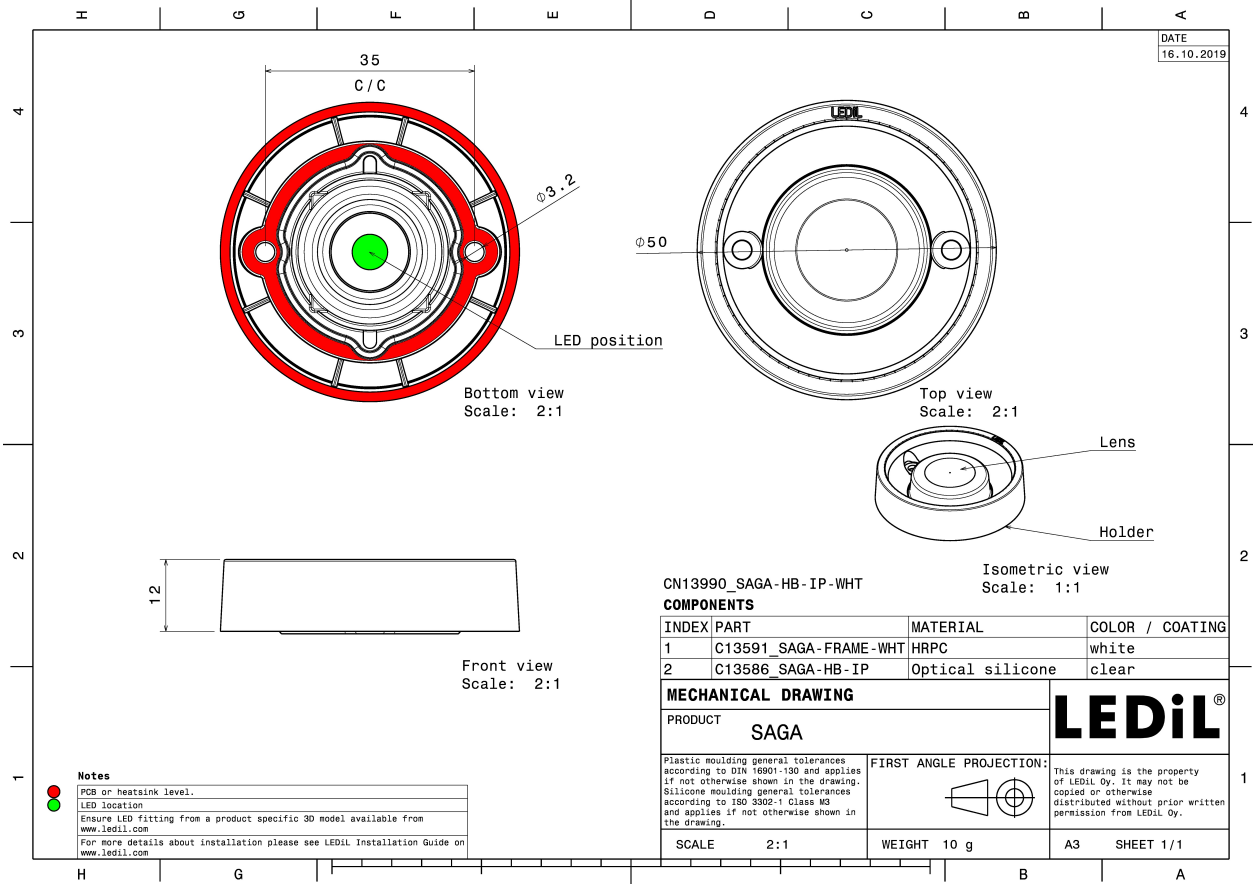





Component		Qty in box	MOQ	MPQ	Box weight (kg)
C13586_SAGA-HB-IP	Single lens	650	52	26	4.7
» Box size: 480 x 280 x 300 mm					
C13591_SAGA-FRAME-WHT	Holder	900	52	26	6.5
» Box size: 480 x 280 x 300 mm					

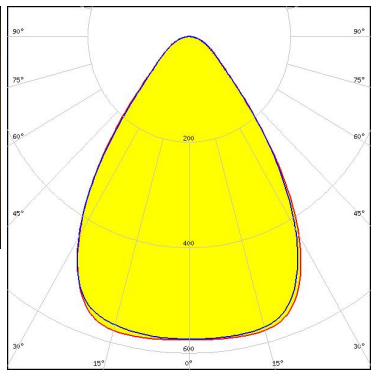

See also our general installation guide: www.ledil.com/installation_guide

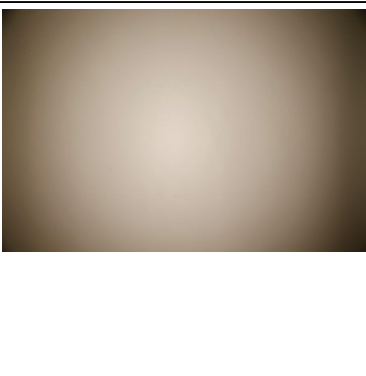
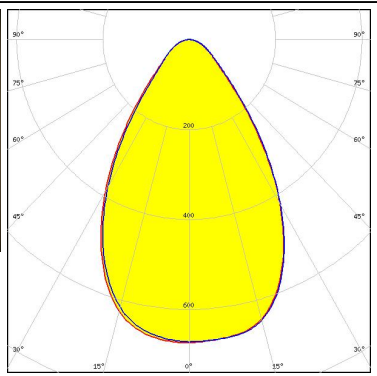
OPTICAL RESULTS (MEASURED):

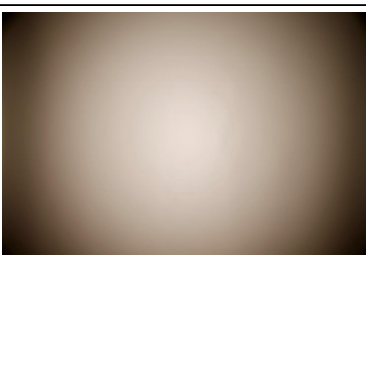
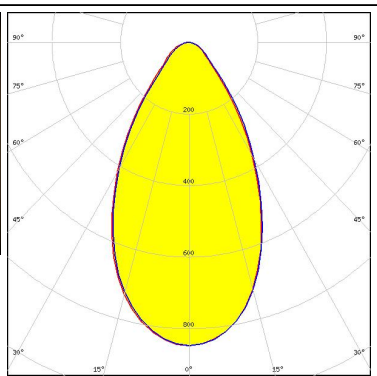
<p></p> <p>LED V10 Gen6 FWHM / FWTM 58.0° / 106.0° Efficiency 89 % Peak intensity 0.8 cd/lm LEDs/each optic 1 Light colour White Required components:</p>		
<p></p> <p>LED V6 Gen6 FWHM / FWTM 73.0° / 115.0° Efficiency 88 % Peak intensity 0.6 cd/lm LEDs/each optic 1 Light colour White Required components:</p>		
<p></p> <p>LED V8 Gen6 FWHM / FWTM 66.0° / 109.0° Efficiency 88 % Peak intensity 0.7 cd/lm LEDs/each optic 1 Light colour White Required components:</p>		
<p></p> <p>LED VERO10 FWHM / FWTM 58.0° / 101.0° Efficiency 92 % Peak intensity 0.9 cd/lm LEDs/each optic 1 Light colour White Required components:</p>		

OPTICAL RESULTS (MEASURED):

CITIZEN

LED CLL01x
 FWHM / FWTM 61.0° / 93.0°
 Efficiency 92 %
 Peak intensity 0.8 cd/lm
 LEDs/each optic 1
 Light colour White
 Required components:

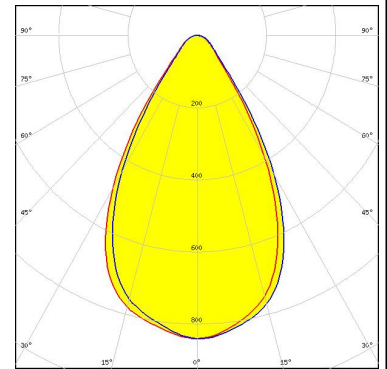

CITIZEN

LED CLL02x/CLU02x (LES10)
 FWHM / FWTM 47.0° / 95.0°
 Efficiency 86 %
 Peak intensity 1 cd/lm
 LEDs/each optic 1
 Light colour White
 Required components:
 Bender Wirth: 434 Typ L6

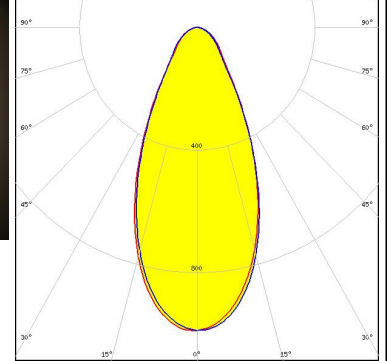
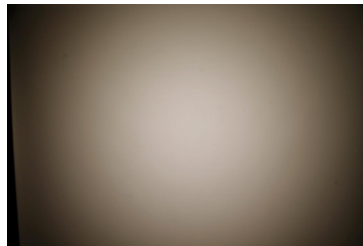

CITIZEN

LED CLL02x/CLU02x (LES10)
 FWHM / FWTM 58.0° / 98.0°
 Efficiency 91 %
 Peak intensity 0.9 cd/lm
 LEDs/each optic 1
 Light colour White
 Required components:

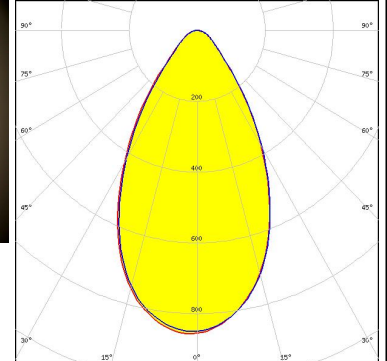
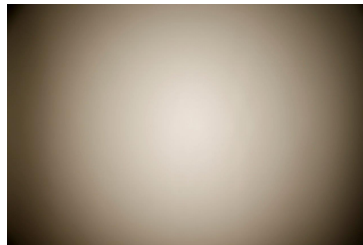

CITIZEN

LED CLL03x/CLU03x
 FWHM / FWTM 64.0° / 116.0°
 Efficiency 92 %
 Peak intensity 0.7 cd/lm
 LEDs/each optic 1
 Light colour White
 Required components:

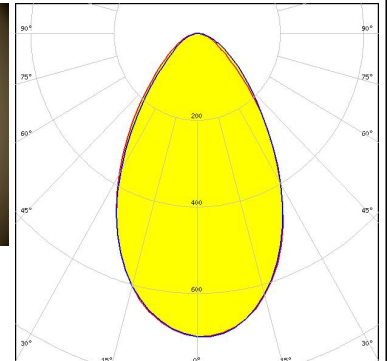
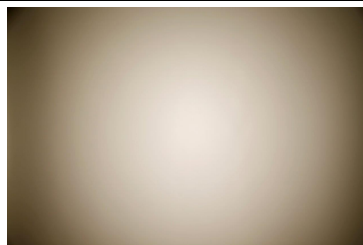

OPTICAL RESULTS (MEASURED):

CITIZEN

LED CLL03x/CLU03x
 FWHM / FWTM 61.0° / 125.0°
 Efficiency 84 %
 Peak intensity 0.6 cd/lm
 LEDs/each optic 1
 Light colour White
 Required components:
 Bender Wirth: 433 Typ L6

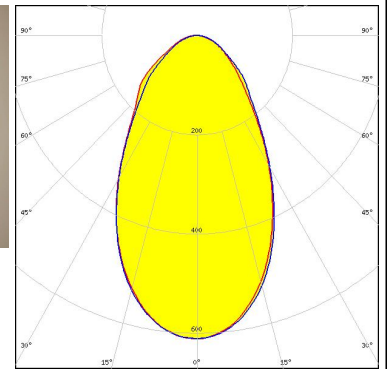

CITIZEN

LED CLU700/701/702/703
 FWHM / FWTM 56.0° / 90.0°
 Efficiency 87 %
 Peak intensity 0.9 cd/lm
 LEDs/each optic 1
 Light colour White
 Required components:

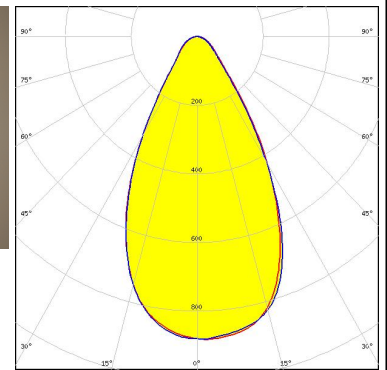
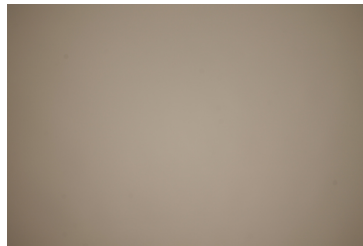

CITIZEN

LED CLU700/701/702/703
 FWHM / FWTM 46.0° / 82.0°
 Efficiency 86 %
 Peak intensity 1.1 cd/lm
 LEDs/each optic 1
 Light colour White
 Required components:
 Bender Wirth: 434 Typ L6

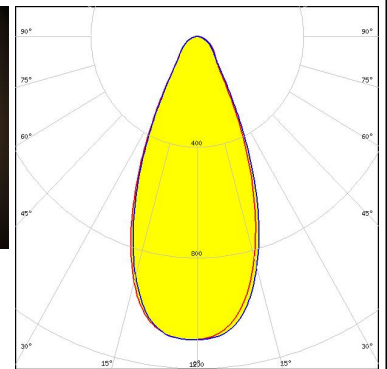
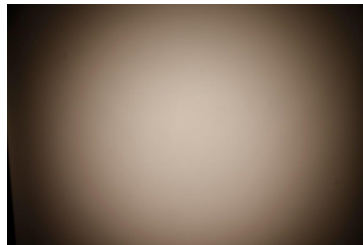

CITIZEN

LED CLU710/711
 FWHM / FWTM 62.0° / 107.0°
 Efficiency 90 %
 Peak intensity 0.7 cd/lm
 LEDs/each optic 1
 Light colour White
 Required components:

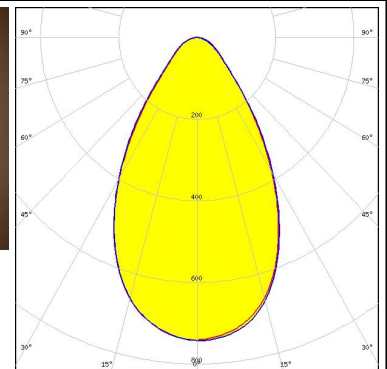
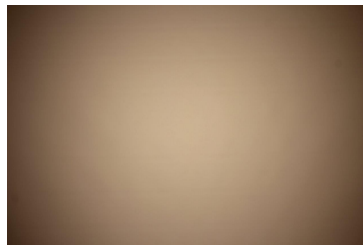

OPTICAL RESULTS (MEASURED):

CITIZEN

LED CLU720/721/723
 FWHM / FWTM 50.0° / 109.0°
 Efficiency 85 %
 Peak intensity 0.9 cd/lm
 LEDs/each optic 1
 Light colour White
 Required components:
 Bender Wirth: 433 Typ L6

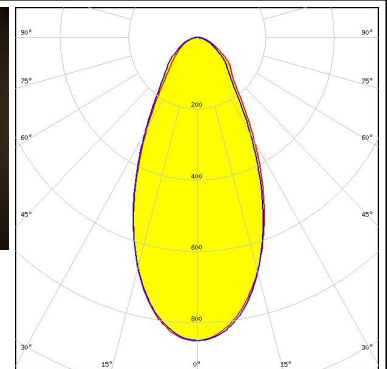
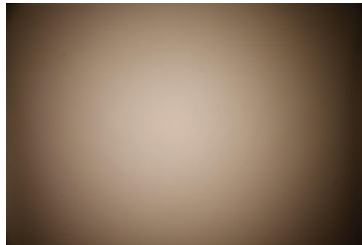

CITIZEN

LED CLU720/721/723
 FWHM / FWTM 61.0° / 113.0°
 Efficiency 89 %
 Peak intensity 0.7 cd/lm
 LEDs/each optic 1
 Light colour White
 Required components:

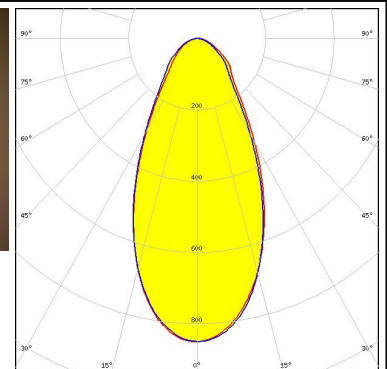
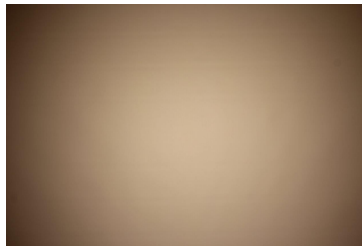

CREE LED

LED CXA/B 13xx
 FWHM / FWTM 70.0° / 104.0°
 Efficiency 92 %
 Peak intensity 0.7 cd/lm
 LEDs/each optic 1
 Light colour White
 Required components:

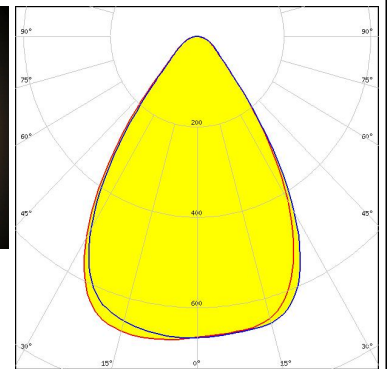
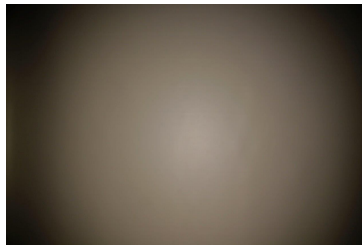

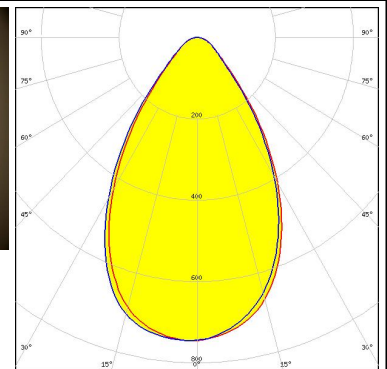
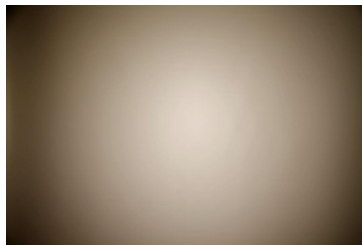

CREE LED

LED CXA/B 15xx
 FWHM / FWTM 64.0° / 104.0°
 Efficiency 92 %
 Peak intensity 0.8 cd/lm
 LEDs/each optic 1
 Light colour White
 Required components:

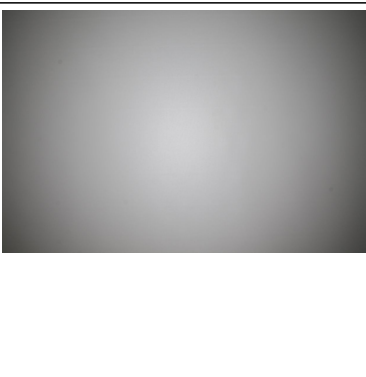
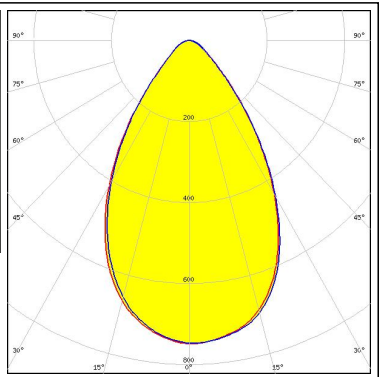

OPTICAL RESULTS (MEASURED):

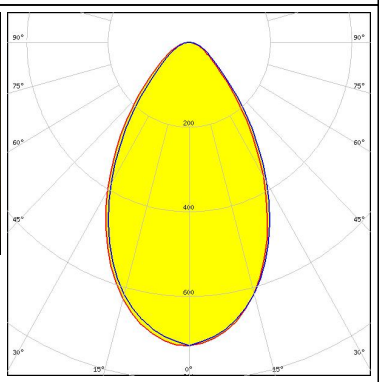
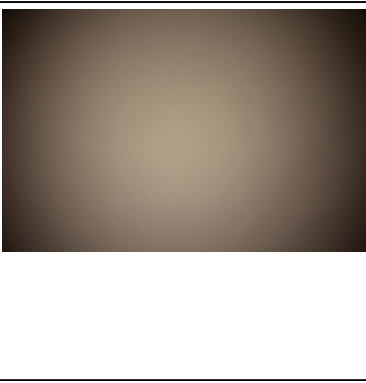
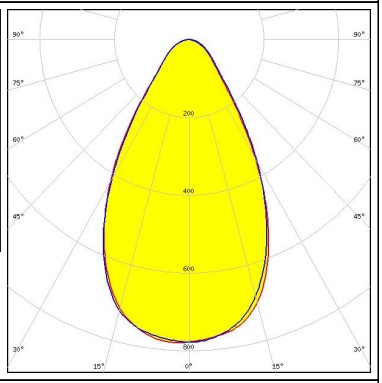
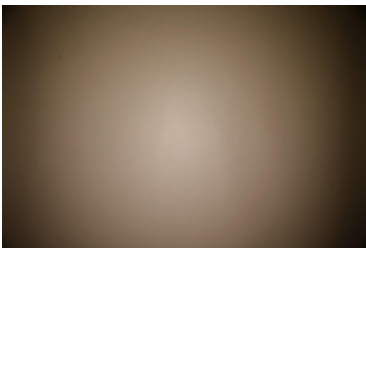
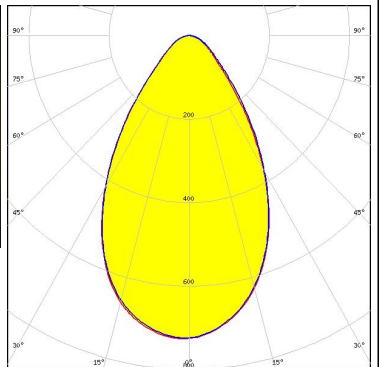
<p>CREE → LED</p> <p>LED CXA/B 15xx FWHM / FWTM 64.0° / 102.0° Efficiency 90 % Peak intensity 0.8 cd/lm LEDs/each optic 1 Light colour White Required components:</p>		
<p>CREE → LED</p> <p>LED CXA/B 1816 & CXA/B 1820 & CXA 1850 FWHM / FWTM 63.0° / 111.0° Efficiency 90 % Peak intensity 0.7 cd/lm LEDs/each optic 1 Light colour White Required components:</p>		
<p>CREE → LED</p> <p>LED MHD-E/G FWHM / FWTM 60.0° / 105.0° Efficiency 90 % Peak intensity 0.8 cd/lm LEDs/each optic 1 Light colour White Required components:</p>		
<p>LUMILEDS</p> <p>LED LUXEON CoB 1202/1203 FWHM / FWTM 63.0° / 108.0° Efficiency 89 % Peak intensity 0.7 cd/lm LEDs/each optic 1 Light colour White Required components:</p>		

OPTICAL RESULTS (MEASURED):

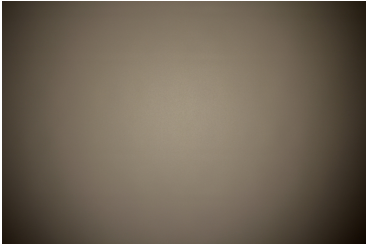
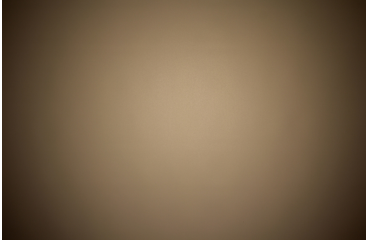
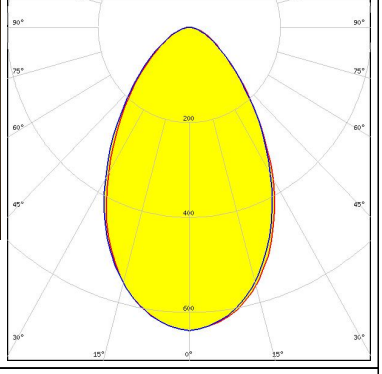
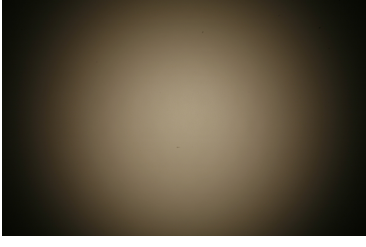
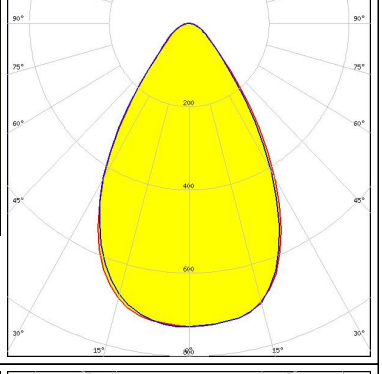
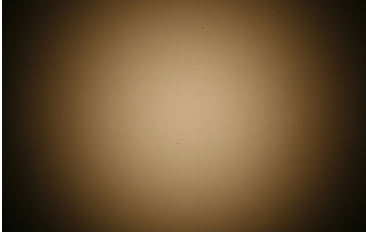
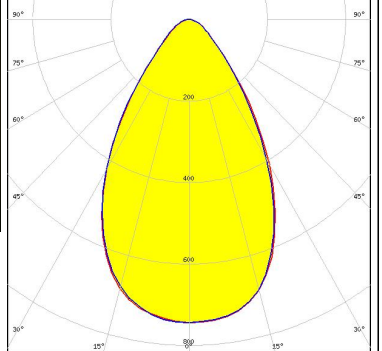
<p>LUMILEDS</p> <p>LED LUXEON CoB 1202s</p> <p>FWHM / FWTM 67.0° / 106.0°</p> <p>Efficiency 90 %</p> <p>Peak intensity 0.7 cd/lm</p> <p>LEDs/each optic 1</p> <p>Light colour White</p> <p>Required components:</p>		
<p>LUMINUS</p> <p>LED CxM-14 (19x19)</p> <p>FWHM / FWTM 66.0° / 121.0°</p> <p>Efficiency 88 %</p> <p>Peak intensity 0.6 cd/lm</p> <p>LEDs/each optic 1</p> <p>Light colour White</p> <p>Required components:</p>		
<p>LUMINUS</p> <p>LED CxM-6 (12x13)</p> <p>FWHM / FWTM 66.0° / 104.0°</p> <p>Efficiency 89 %</p> <p>Peak intensity 0.7 cd/lm</p> <p>LEDs/each optic 1</p> <p>Light colour White</p> <p>Required components:</p>		
<p>LUMINUS</p> <p>LED CXM-7 (13x13)</p> <p>FWHM / FWTM 64.0° / 105.0°</p> <p>Efficiency 89 %</p> <p>Peak intensity 0.8 cd/lm</p> <p>LEDs/each optic 1</p> <p>Light colour White</p> <p>Required components:</p>		

OPTICAL RESULTS (MEASURED):



LED CxM-9 (13.5x13.5)
 FWHM / FWTM 63.0° / 109.0°
 Efficiency 88 %
 Peak intensity 0.7 cd/lm
 LEDs/each optic 1
 Light colour White
 Required components:

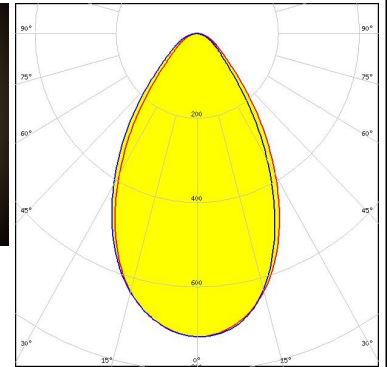
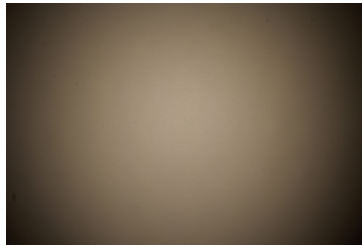

LED Duris S10
 FWHM / FWTM 74.0° / 106.0°
 Efficiency 91 %
 Peak intensity 0.7 cd/lm
 LEDs/each optic 1
 Light colour White
 Required components:

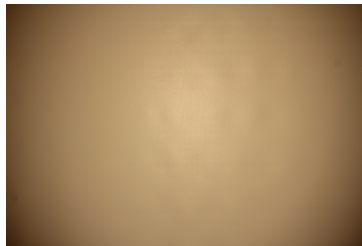

LED Soleriq S13
 FWHM / FWTM 61.0° / 110.0°
 Efficiency 91 %
 Peak intensity 0.8 cd/lm
 LEDs/each optic 1
 Light colour White
 Required components:

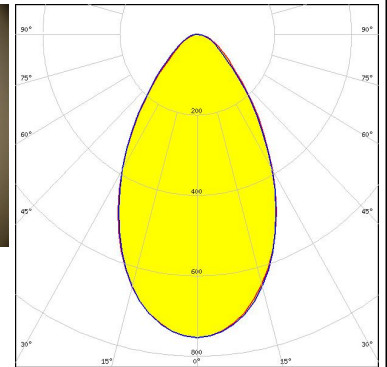
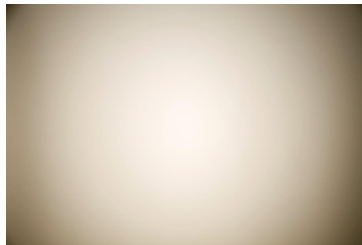

SEOL SEMICONDUCTOR
 LED MJT COB LES 6
 FWHM / FWTM 46.0° / 79.0°
 Efficiency 87 %
 Peak intensity 1.1 cd/lm
 LEDs/each optic 1
 Light colour White
 Required components:
 Bender Wirth: 434 Typ L6

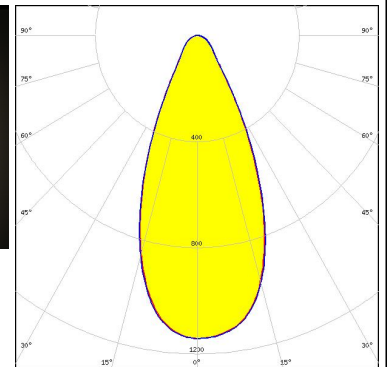
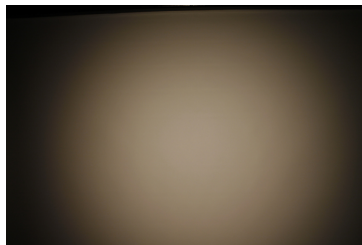

OPTICAL RESULTS (MEASURED):

SHARP

LED	Mini Zenigata (GW6BM)
FWHM / FWTM	62.0° / 100.0°
Efficiency	92 %
Peak intensity	0.8 cd/lm
LEDs/each optic	1
Light colour	White
Required components:	

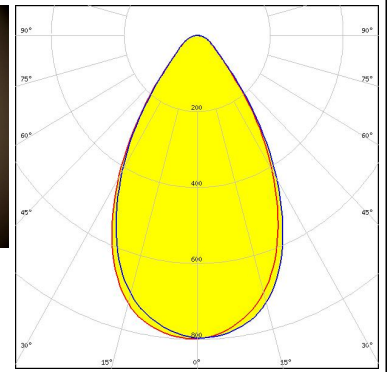
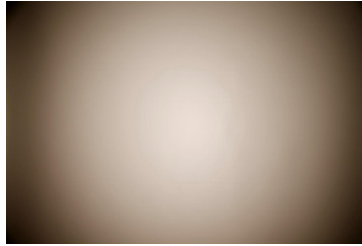

OPTICAL RESULTS (SIMULATED):

LUMILEDS

LED LUXEON CoB Compact
 FWHM / FWTM 67.0° / 106.0°
 Efficiency 90 %
 Peak intensity 0.7 cd/lm
 LEDs/each optic 1
 Light colour White
 Required components:

LUMINUS

LED CxM-14 (19x19)
 FWHM / FWTM 61.0° / 125.0°
 Efficiency 84 %
 Peak intensity 0.6 cd/lm
 LEDs/each optic 1
 Light colour White
 Required components:
 Bender Wirth: 433 Typ L6

LUMINUS

LED CxM-9 (13.5x13.5)
 FWHM / FWTM 47.0° / 95.0°
 Efficiency 86 %
 Peak intensity 1 cd/lm
 LEDs/each optic 1
 Light colour White
 Required components:
 Bender Wirth: 434 Typ L6

NICHIA

LED COB S-Type (LES 7)
 FWHM / FWTM 64.0° / 84.0°
 Efficiency 95 %
 Peak intensity 1 cd/lm
 LEDs/each optic 1
 Light colour White
 Required components:

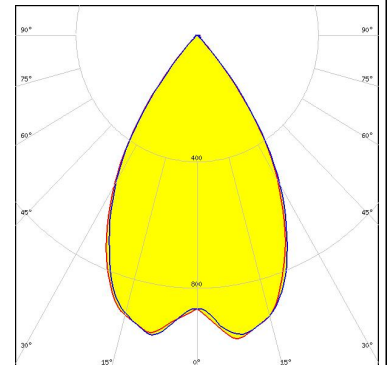

OPTICAL RESULTS (SIMULATED):

OSRAM

Opto Semiconductors

LED Soleriq S9
 FWHM / FWTM 56.0° / 87.0°
 Efficiency 93 %
 Peak intensity 1.1 cd/lm
 LEDs/each optic 1
 Light colour White
 Required components:

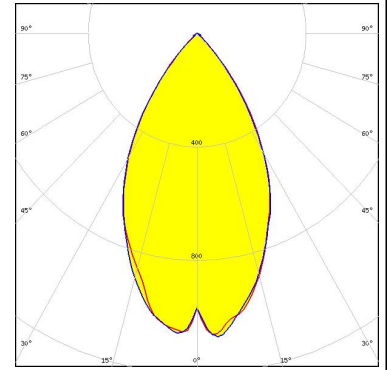

SAMSUNG

LED LC020C
 FWHM / FWTM 42.0° / 66.0°
 Efficiency 87 %
 Peak intensity 1.6 cd/lm
 LEDs/each optic 1
 Light colour White
 Required components:
 Bender Wirth: 479 Typ L6

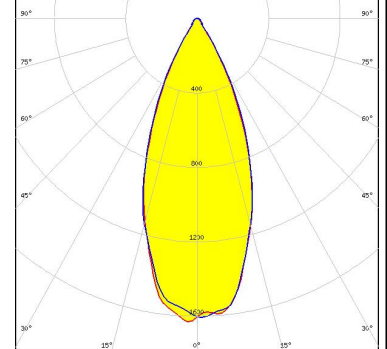

SAMSUNG

LED LC040C
 FWHM / FWTM 51.0° / 81.0°
 Efficiency 87 %
 Peak intensity 1.1 cd/lm
 LEDs/each optic 1
 Light colour White
 Required components:
 Bender Wirth: 480 Typ L6

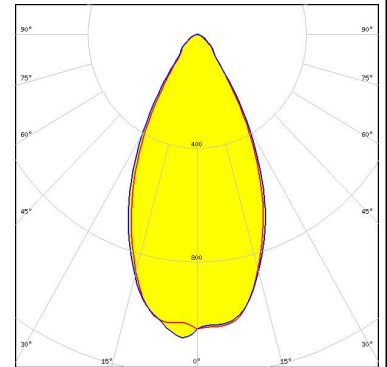

SEOUL SEMICONDUCTOR

LED ZC12/18
 FWHM / FWTM 61.0° / 125.0°
 Efficiency 84 %
 Peak intensity 0.6 cd/lm
 LEDs/each optic 1
 Light colour White
 Required components:
 Bender Wirth: 433 Typ L6

OPTICAL RESULTS (SIMULATED):

	
SEOUL SEMICONDUCTOR	
LED	ZC4/6
FWHM / FWTM	47.0° / 95.0°
Efficiency	86 %
Peak intensity	1 cd/lm
LEDs/each optic	1
Light colour	White
Required components:	
Bender Wirth: 434 Typ L6	

GENERAL INFORMATION:

NOTE: The typical beam angle will be changed by different color, chip size and chip position tolerance. The typical total beam angle is the full angle measured where the luminous intensity is half of the peak value.

Due to use of high power COB's with this product, special attention to proper thermal design is highly recommended. LEDiL has no liability for direct, indirect or consecutive damages arising from the LEDiL products being used outside of the recommended temperature range.

MATERIALS:

As part of our continuous research and improvement processes, and to ensure the best possible quality and availability of our products, LEDiL reserves the right to change material grades without notice.

PRODUCT DATA USER AGREEMENT AND DISCLAIMER:

The measured data in the provided downloadable LEDiL Product Datasheets and Mechanical 2D-Drawings is rounded and provided as reference for planning. LEDiL Oy's optical specifications have been verified by conducting performance testing of the products in accordance with the company's quality system. The reported data are averaged results of multiple measurements with typical variation. LEDiL Oy reserves the right to without prior notification make changes and improvements to its products.

LEDiL Oy assumes neither warranty, nor guarantee nor any other liability of any kind for the contents and correctness of the provided data. The provided data has been generated with highest diligence but the provided data may in reality not represent the complete possible variation range of all intrinsic parameters. Therefore, in certain cases a deviation from the provided data could occur.

LEDiL Oy reserves the right to undertake technical changes of its products without further notification which could lead to changes in the provided data. LEDiL Oy assumes no liability of any kind for the possible deviation from any provided data or any other damage resulting from the usage of the provided data.

The user agrees to this disclaimer and user agreement with the download or usage of the provided files.

LEDiL Oy

Joensuunkatu 13
FI-24240 SALO
Finland

LEDiL Inc.

228 West Page Street
Suite D
Sycamore IL 60178
USA

Ledil Optics Technology (Shenzhen) Co., Ltd.

405 , Block B
Casic Motor Building
Shenzhen 518057
P.R.CHINA

Local sales and technical support

[www.ledil.com/
where_to_buy](http://www.ledil.com/where_to_buy)

Shipping locations

Salo, Finland
Hong Kong, China

Distribution Partners

[www.ledil.com/
where_to_buy](http://www.ledil.com/where_to_buy)