

T370D225M035AS

T370, Tantalum, MnO₂ Tantalum, Commercial Grade, 2.2 uF, 20%, 35 VDC, 5 Ohms, Lead Spacing = 4.57mm

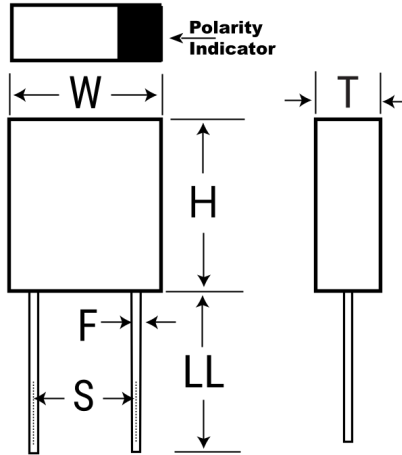

Click [here](#) for the 3D model.

Dimensions	
W	5.59mm MAX
H	7.37mm MAX
T	2.79mm MAX
S	4.57mm +/-0.64mm
LL	19.1mm MIN
F	0.41mm MAX

Packaging Specifications	
Packaging	Bulk, Bag
Packaging Quantity	500

General Information	
Series	T370
Dielectric	MnO ₂ Tantalum
Style	Radial Molded
Description	Radial, Solid Tantalum, Micro Miniature
Features	Micro Miniature
RoHS	No
Prop 65	⚠ WARNING: Cancer and reproductive harm - http://www.p65warnings.ca.gov .
SCIP Number	a3b4e2e1-63ea-439e-a89a-743225502a7d
Termination	Lead (SnPb)
AEC-Q200	No
Construction	Molded

Specifications	
Capacitance	2.2 uF
Capacitance Tolerance	20%
Voltage DC	35 VDC (85C), 23 VDC (125C), 0.35 VDC (125C Reverse)
Temperature Range	-55/+125°C
Dissipation Factor	6%
Resistance	5 Ohms (100kHz)
Leakage Current	2 uA

Statements of suitability for certain applications are based on our knowledge of typical operating conditions for such applications, but are not intended to constitute - and we specifically disclaim - any warranty concerning suitability for a specific customer application or use. This information is intended for use only by customers who have the requisite experience and capability to determine the correct products for their application. Any technical advice inferred from this information or otherwise provided by us with reference to the use of our products is given gratis, and we assume no obligation or liability for the advice given or results obtained.