



PJS6630

20V P- MOSFET Load Switch with Level Shift & Adjustable Slew Rate

Voltage

20 V

Current

3.6A

Features

- $V_{drop} = 0.2V @ V_{in}=12V, I_L=3.6A, R_{DS(ON)}= 53m\Omega$
- $V_{drop} = 0.2V @ V_{in}=5.0V, I_L=3.4A, R_{DS(ON)}= 57m\Omega$
- $V_{drop} = 0.2V @ V_{in}=2.5V, I_L=2.8A, R_{DS(ON)}= 70m\Omega$
- Advanced Trench Process Technology
- Adjustable Turn on/off Slew Rate Control through external R1, R2 and C1.
- Lead free in compliance with EU RoHS 2.0
- Green molding compound as per IEC 61249 standard

Mechanical Data

- Case: SOT-23 6L Package
- Terminals: Solderable per MIL-STD-750, Method 2026
- Approx. Weight: 0.0005 ounces, 0.014 grams
- Marking: SL0

SOT-23 6L

Unit : inch(mm)

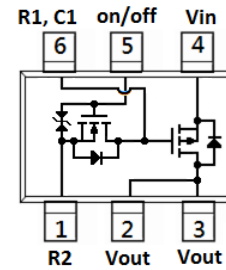
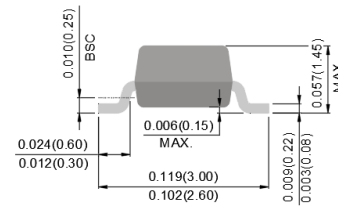
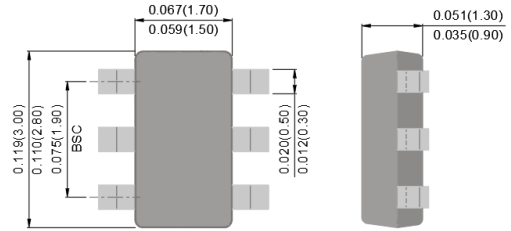

Maximum Ratings and Thermal Characteristics (T_A=25°C unless otherwise noted)

PARAMETER	SYMBOL	RATING	UNITS
Input Voltage Range ^(Note 1)	V _{IN}	20	V
On/Off Voltage Range	V _{ON} /V _{OFF}	12	V
Continuous Load Current ^(Note 2,3)	I _D	3.6	A
Pulsed Load Current ^(Note 4)	I _D	14.4	A
Power Dissipation ^(Note 2)	P _D	0.83	W
Operating Junction and Storage Temperature Range	T _J , T _{STG}	-55~150	°C
ESD, MIL-STD-883D HBM (100pF/1.5kohm) (Von/off pin)	V _{ESD}	2	kV
Typical Junction to Ambient ^(Note 2)	R _{θJA}	150	°C/W



PJS6630

Electrical Characteristics (T_A=25°C unless otherwise noted)

PARAMETER	SYMBOL	TEST CONDITION	MIN.	TYP.	MAX.	UNITS
Off Characteristics						
Leakage Current	I _{FL}	V _{IN} =20V, V _{ON} /V _{OFF} =0V	-	-	1	uA
Diode Forward Voltage	V _{SD}	I _S =-1.0A	-	-0.76	-1.2	V
On Characteristics						
Input Voltage Range	V _{IN}		2.5	-	20	V
On/Off Voltage Range	V _{ON} /V _{OFF}		2.5	-	12	V
Drain-Source On-State Resistance (Q2)	R _{DS(on)}	V _{GS} =-12V, I _D =-3.6A	-	45	53	mΩ
		V _{GS} =-5.0V, I _D =-3.4A	-	49	57	
		V _{GS} =-2.5V, I _D =-2.8A	-	59	70	

NOTES :

- V_{IN} Range can be up to 20V, but R1 and R2 must be scaled such that V_{GS} do not exceed 12V.
- R_{ΘJA} is the sum of the junction-to-case and case-to-ambient thermal resistance where the case thermal reference is defined as the solder mounting surface of the drain pins mounted on a 1 inch FR-4 with 2oz. square pad of copper
- The maximum current rating is package limited
- Pulse test: pulse width ≤ 300uS, duty cycle ≤ 2%

Application Circuits

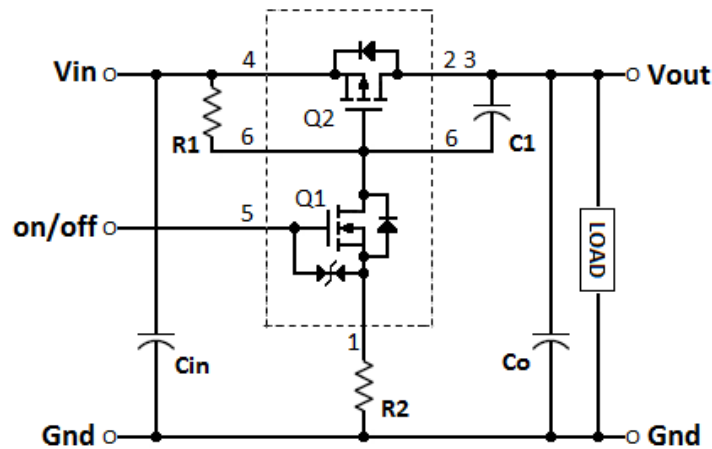

Component Table		
R1	Pull-Up Resistor	Typical 10kΩ to 1MΩ
R2	Optional Slew-Rate Control	Typical 0kΩ to 100kΩ
C1	Optional Slew-Rate Control	Typical 1uF
Note: R1 should be at least 10 * R2 to ensure Q1 turn-on		



PJS6630

TYPICAL CHARACTERISTIC CURVES

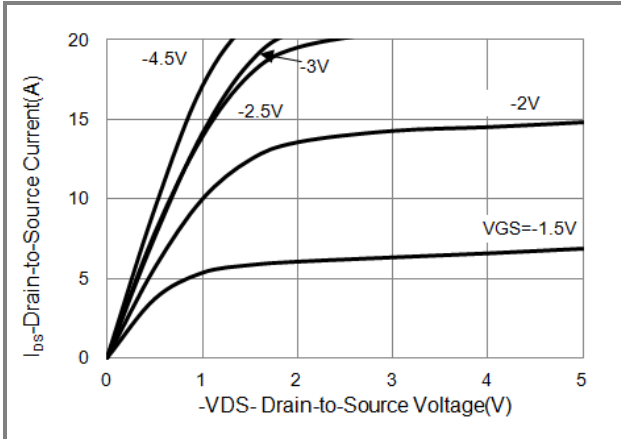

Fig.1 Output Characteristics

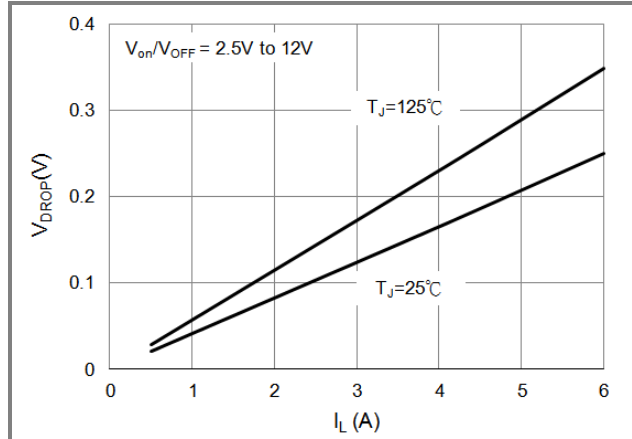

Fig.2 Vdrop vs Load Current at $V_{in}= 12V$

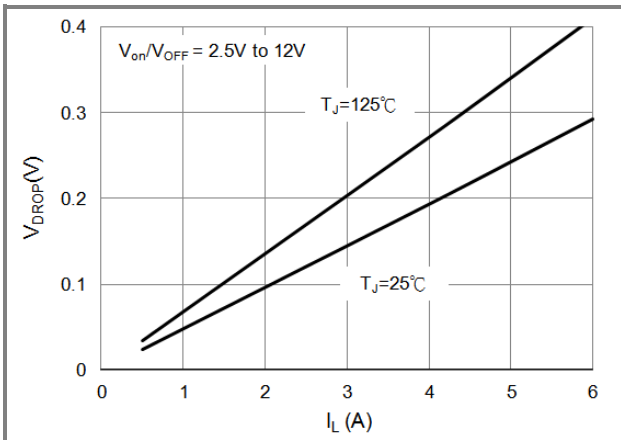

Fig.3 Vdrop vs Load Current at $V_{in}= 4.5V$

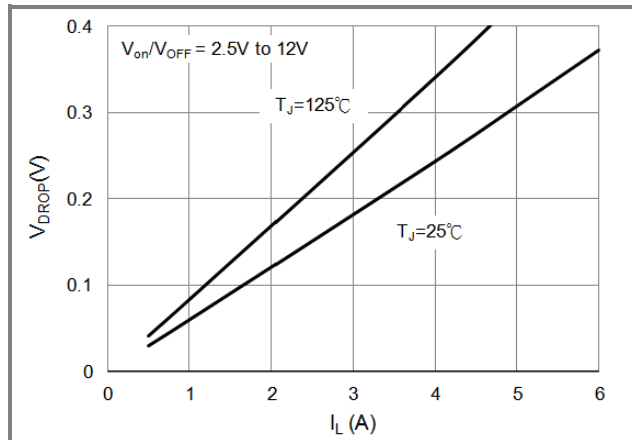

Fig.4 Vdrop vs Load Current at $V_{in}= 2.5V$

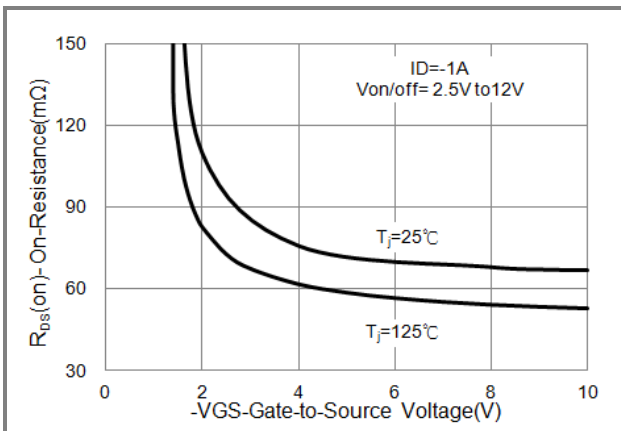

Fig.5 On-Resistance Variation with VGS.

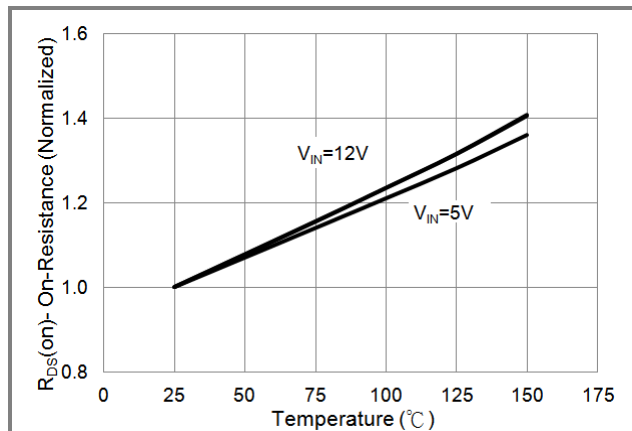

Fig.6 Normalize Rds(on) vs Junction Temperature



PJS6630

TYPICAL CHARACTERISTIC CURVES

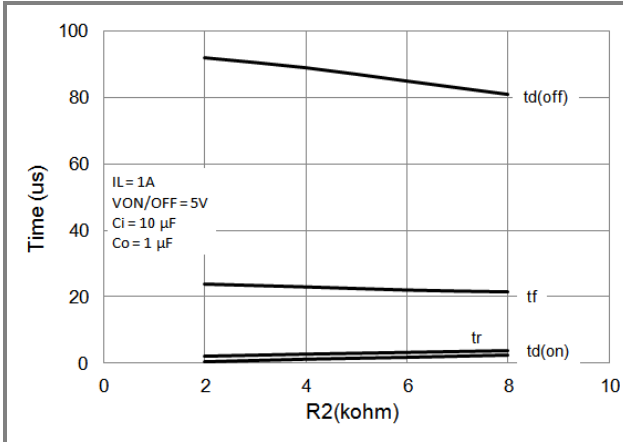

Fig.7 Switching Variation R2 at Vin=12V, R1=20k Ω

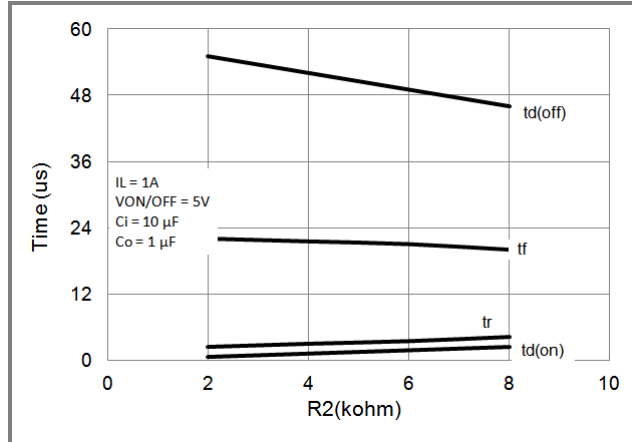

Fig.8 Switching Variation R2 at Vin= 5V, R1= 20k Ω

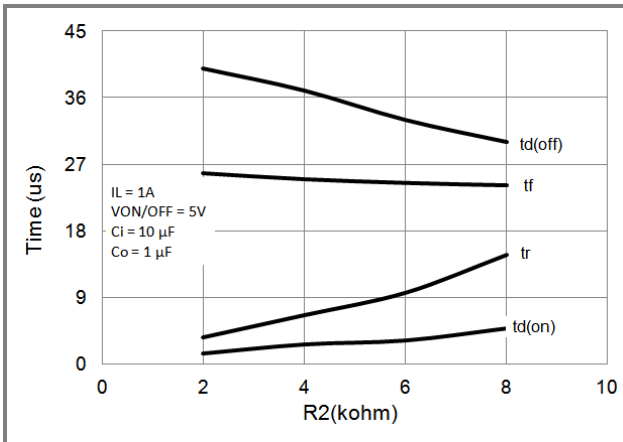

Fig.9 Switching Variation R2 at Vin=3.3V, R1=20k Ω

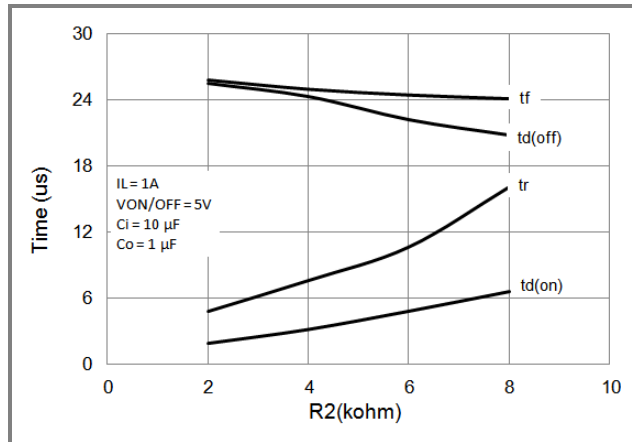

Fig.10 Switching Variation R2 at Vin=2.5V, R1=20k Ω

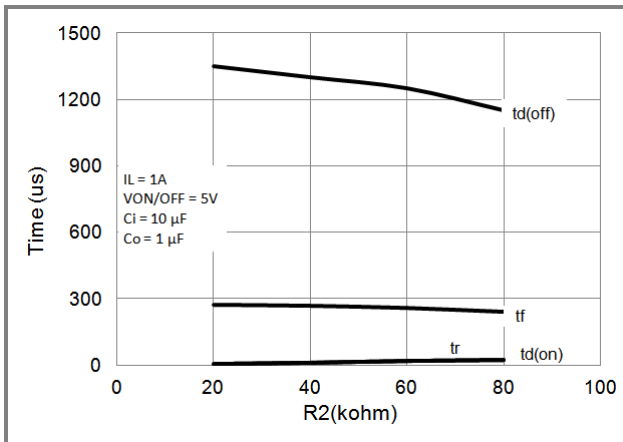

Fig.11 Switching Variation R2 at Vin=12V, R1=300k

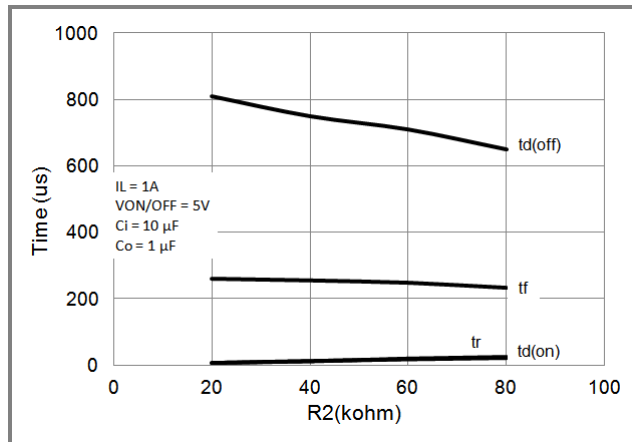

Fig.12 Switching Variation R2 at Vin=5V, R1=300k



PJS6630

TYPICAL CHARACTERISTIC CURVES

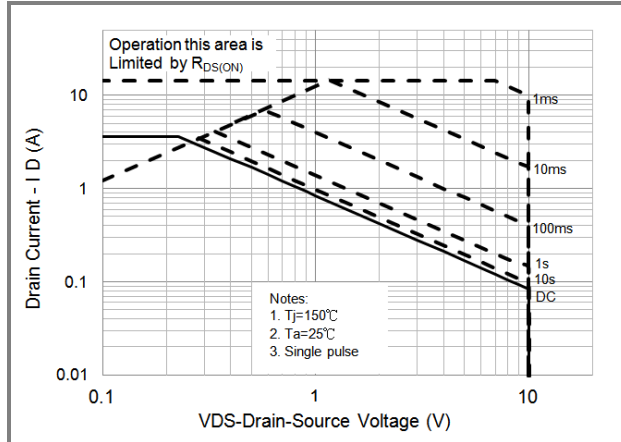

Fig.13 Switching Variation R2 at $V_{in} = 12\text{V}$, $R_1 = 20\text{k}\Omega$

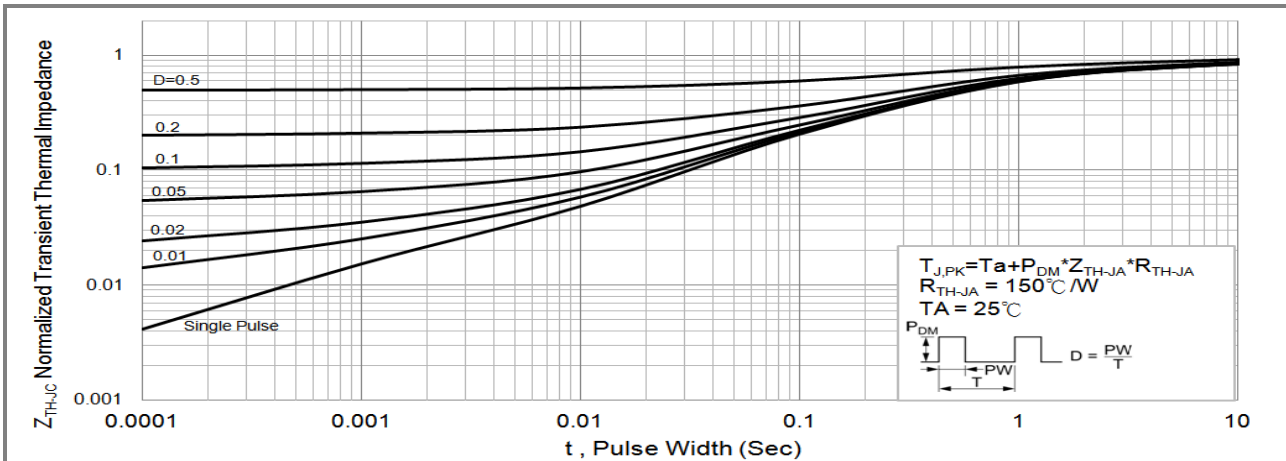

Fig.14 Transient Thermal Response Curve



PJS6630

PART NO. PACKING CODE VERSION

Part No. Packing Code	Package Type	Packing Type	Marking	Version
PJS6630_S1_00001	SOT-23 6L	3K pcs / 7" reel	SL0	Halogen free RoHS compliant
PJS6630_S2_00001	SOT-23 6L	10K pcs / 13" reel	SL0	Halogen free RoHS compliant

MOUNTING PAD LAYOUT

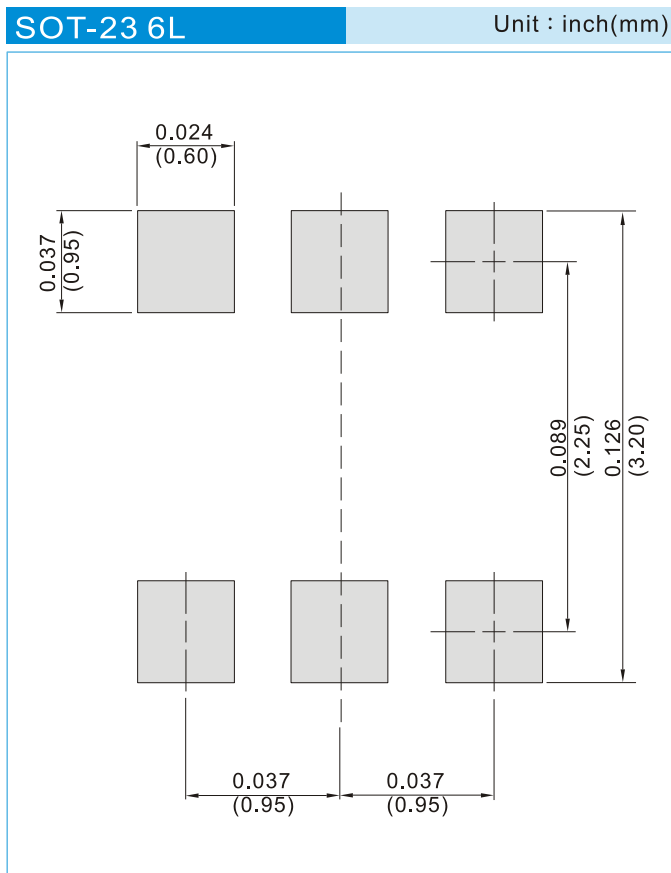



PJS6630

Disclaimer

- Reproducing and modifying information of the document is prohibited without permission from Panjit International Inc..
- Panjit International Inc. reserves the rights to make changes of the content herein the document anytime without notification. Please refer to our website for the latest document.
- Panjit International Inc. disclaims any and all liability arising out of the application or use of any product including damages incidentally and consequentially occurred.
- Panjit International Inc. does not assume any and all implied warranties, including warranties of fitness for particular purpose, non-infringement and merchantability.
- Applications shown on the herein document are examples of standard use and operation. Customers are responsible in comprehending the suitable use in particular applications. Panjit International Inc. makes no representation or warranty that such applications will be suitable for the specified use without further testing or modification.
- The products shown herein are not designed and authorized for equipments requiring high level of reliability or relating to human life and for any applications concerning life-saving or life-sustaining, such as medical instruments, transportation equipment, aerospace machinery et cetera. Customers using or selling these products for use in such applications do so at their own risk and agree to fully indemnify Panjit International Inc. for any damages resulting from such improper use or sale.
- Since Panjit uses lot number as the tracking base, please provide the lot number for tracking when complaining.