

| TOLERANCE UNLESS OTHERWISE SPECIFIED | |
|--|-------|
| .X | ±0.25 |
| .XX | ±0.13 |
| .XXX | ±0.10 |

THIS IS A C.A.D. GENERATED DRAWING
DO NOT MAKE MANUAL REVISIONS TO MASTER.

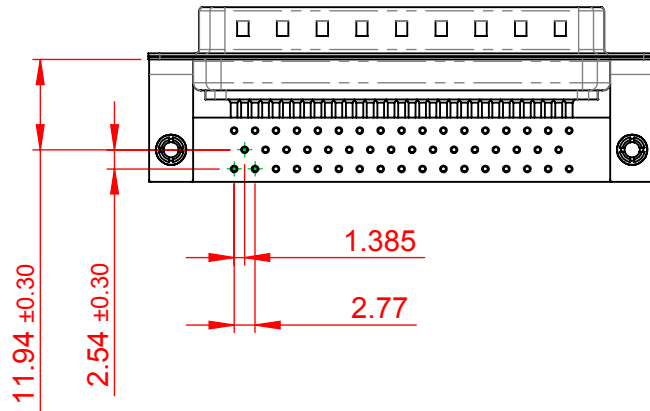

| | |
|--------------|---|
| ISSUE NUMBER | |
| ORIGINAL | ① |

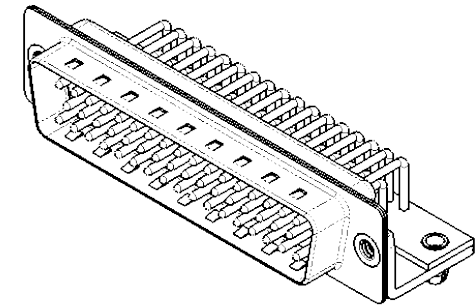
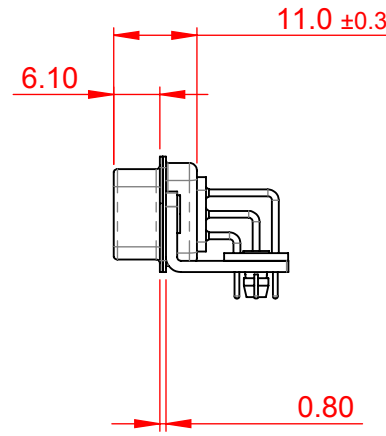
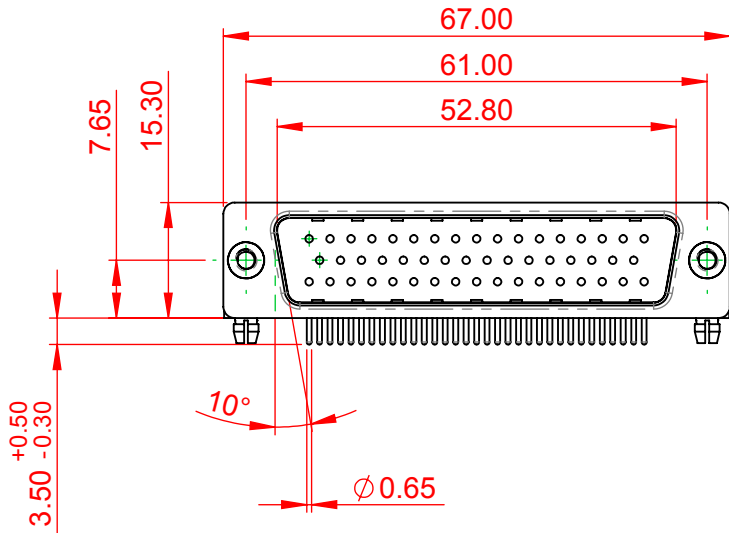

NOTES:

MATERIAL:
HOUSING: PA6T, UL94V-0
SHELL: STEEL, Sn or Ni PLATED
CONTACT: PRECISION MACHINED COPPER ALLOY
SEE ORDERING GUIDE FOR CONTACT PLATING

OPERATING TEMPERATURE: -55°C ~ 125°C

CURRENT RATING: 5A PER CONTACT
CONTACT RESISTANCE: 10mΩ MAX.
INSULATOR RESISTANCE: 5000MΩ min.
DIELECTRIC
WITHSTANDING VOLTAGE: 100V AC rms



THIS SERIES FULLY CONFORMS TO
THE EUROPEAN UNION DIRECTIVES
2011/65/EU FOR RoHS COMPLIANCY.



YOUR CONNECTION TO QUALITY & SERVICE

EDAC INC
TORONTO, ONTARIO
CANADA

THESE DRAWINGS AND SPECIFICATIONS
ARE THE PROPERTY OF EDAC INC., AND
SHALL NOT BE REPRODUCED, OR COPIED
OR USED AS THE BASIS FOR THE
MANUFACTURE OR SALE OF APPARATUS
WITHOUT WRITTEN PERMISSION.

629M SERIES D-SUB CONNECTOR

| | |
|---------------------------------|--------------------|
| SW REFERENCE NO.: 629M ASSEMBLY | |
| DRAWN: C.B | DATE: AUG. 01/2018 |
| CHECKED: | DATE: |
| SCALE: 1:1 | SHEET 1 OF 1 |
| DRAWING NUMBER: 629-M50-240-GT3 | ISSUE |
| PART NUMBER: 629-M50-240-GT3 | 1 |