

**Data sheet | Item number: 831-3208/109-000**

1-conductor male connector; Push-in CAGE CLAMP®; 10 mm<sup>2</sup>; Pin spacing 7.62 mm; 8-pole; 100% protected against mismatching; Threaded flange; 10,00 mm<sup>2</sup>; light gray

[www.wago.com/831-3208/109-000](http://www.wago.com/831-3208/109-000)

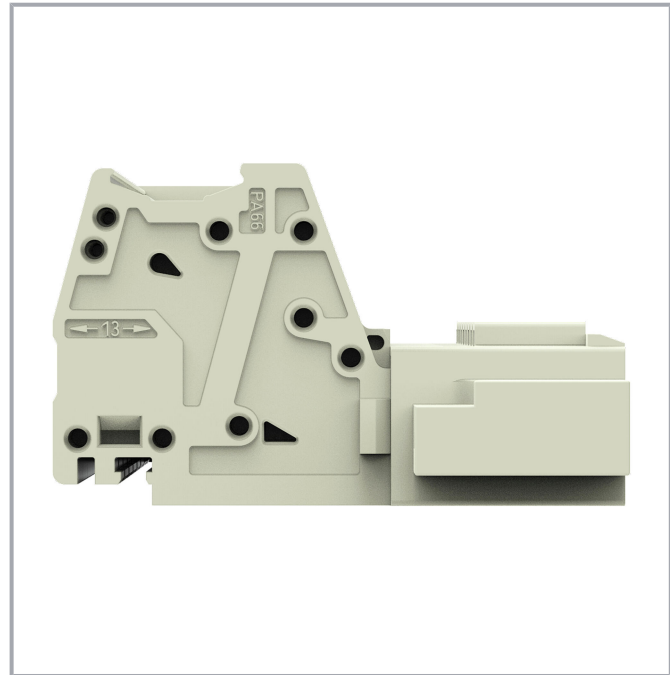
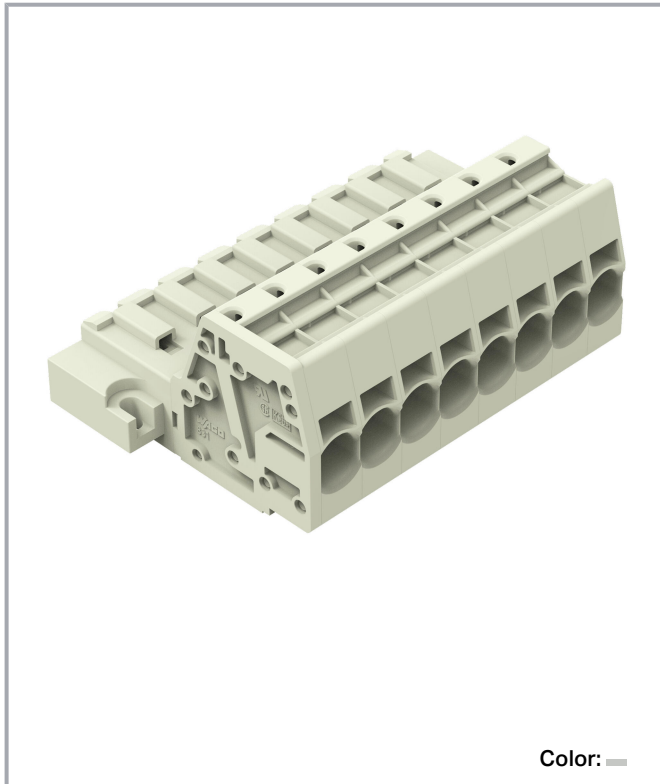

Subject to changes. Please also observe the further product documentation!

WAGO GmbH & Co. KG  
Hansastr. 27  
32423 Minden  
Phone: +49571 887-0 | Fax: +49571 887-169  
Email: [info.de@wago.com](mailto:info.de@wago.com) | Web: [www.wago.com](http://www.wago.com)

Do you have any questions about our products?  
We are always happy to take your call at +49 (571) 887-44222.

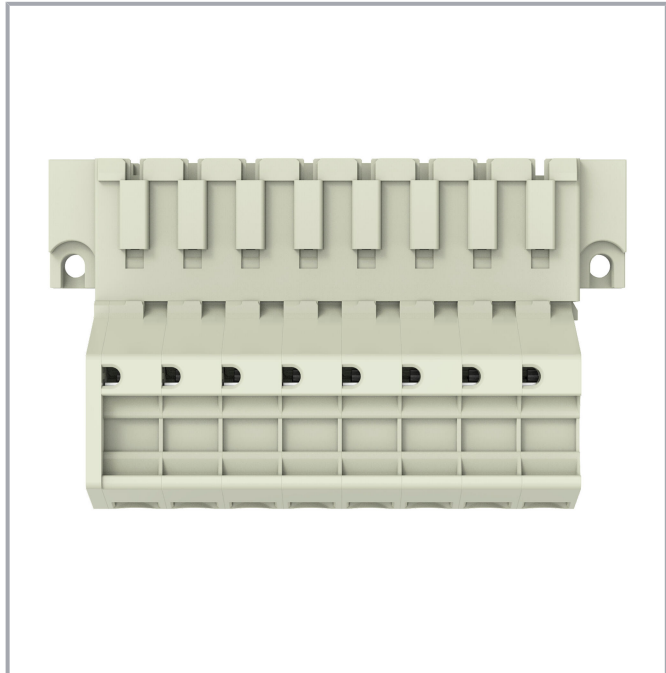
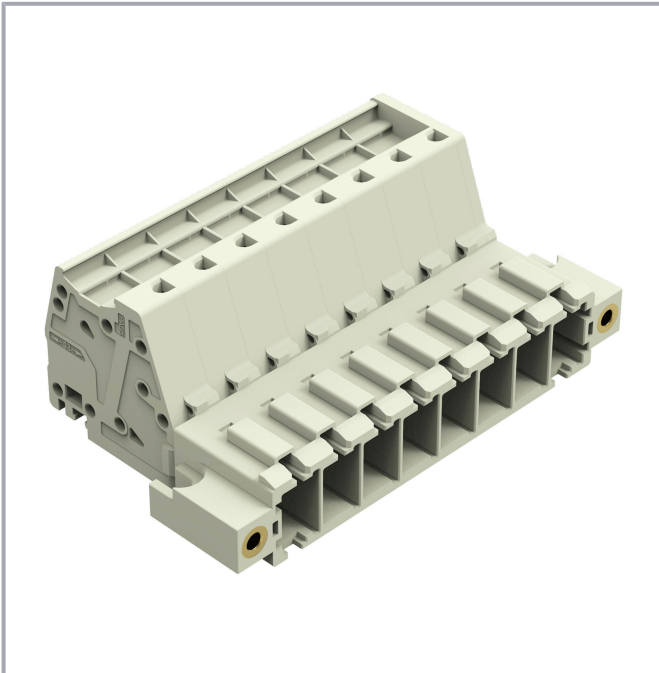

### Derating Curve

1-conductor female connector (831-3102) with

1-conductor male connector (831-3202)

Pin spacing: 7.62 mm / Conductor cross-section: 10 mm<sup>2</sup> "f-st"

Based on: EN 60512-5-2 / Reduction factor: 0.8

Current in A

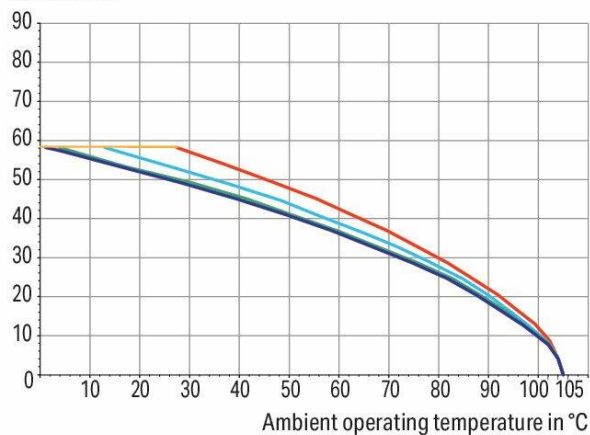

2-, 4-, 6-, 8- pole

Conductor rated current

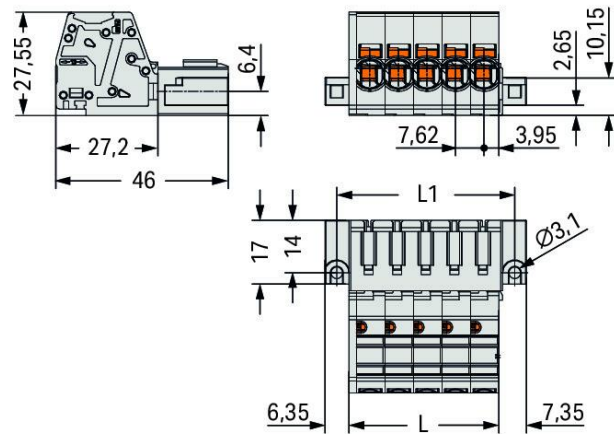

Dimensions in mm

$L = \text{pole no.} \times \text{pin spacing} + 1.9 \text{ mm}$

$L1 = L + 7.5 \text{ mm}$

Subject to changes. Please also observe the further product documentation!

WAGO GmbH & Co. KG

Hansastr. 27

32423 Minden

Phone: +49571 887-0 | Fax: +49571 887-169

Email: [info.de@wago.com](mailto:info.de@wago.com) | Web: [www.wago.com](http://www.wago.com)

Do you have any questions about our products?

We are always happy to take your call at +49 (571) 887-44222.



## Item description

- Universal connection for all conductor types
- Push-in termination of solid or ferruled conductors
- Integrated test ports for 2 mm Ø test plugs
- 600 V UL per UL 1059
- 100 % protected against mismatching
- Coding via coding fingers

## Data

### Notes

#### Safety information

The *MCS – MULTI CONNECTION SYSTEM* includes connectors without breaking capacity in accordance with DIN EN 61984. When used as intended, these connectors must not be connected /disconnected when live or under load. When used as intended, these connectors must not be connected/disconnected when live or under load. The circuit design should ensure header pins, which can be touched, are not live when unmated.

#### Variants:

Other pole numbers

Other versions (or variants) can be requested from WAGO Sales or configured at <https://configurator.wago.com/>.

## Electrical data

### Ratings per IEC/EN

Ratings per	IEC/EN 60664-1
Nominal voltage (III/3)	800 V
Rated impulse voltage (III/3)	8 kV
Rated voltage (III/2)	1000 V
Rated impulse voltage (III/2)	8 kV
Nominal voltage (II/2)	1000 V
Rated surge voltage (II/2)	8 kV
Rated current	41 A
Legend (ratings)	(III / 2) ≙ Overvoltage category III / Pollution degree 2

### Ratings per UL 1059

Approvals per	UL 1059
---------------	---------

Subject to changes. Please also observe the further product documentation!

WAGO GmbH & Co. KG

Hansastr. 27

32423 Minden

Phone: +49571 887-0 | Fax: +49571 887-169

Email: [info.de@wago.com](mailto:info.de@wago.com) | Web: [www.wago.com](http://www.wago.com)

Do you have any questions about our products?

We are always happy to take your call at +49 (571) 887-44222.



Rated voltage UL (Use Group C)	600 V
Rated current UL (Use Group C)	42 A

### Ratings per CSA

Approvals per	CSA
Rated voltage CSA (Use Group C)	600 V
Rated current CSA (Use Group C)	41 A

### Connection data

Total number of potentials	8
Number of connection types	1
Number of levels	1

### Connection 1

Connection technology	Push-in CAGE CLAMP®
Actuation type	Operating tool
Actuation direction 1	Operation parallel to conductor entry
Solid conductor	0.5 ... 10 mm <sup>2</sup> / 20 ... 8 AWG
Fine-stranded conductor	0.5 ... 10 mm <sup>2</sup> / 20 ... 8 AWG
Fine-stranded conductor; with insulated ferrule	0.5 ... 6 mm <sup>2</sup>
Fine-stranded conductor; with uninsulated ferrule	0.5 ... 6 mm <sup>2</sup>
Strip length	13 ... 15 mm / 0.51 ... 0.59 inches
Pole number	8
Conductor entry direction to mating direction	0°

### Physical data

Pin spacing	7.62 mm / 0.3 inches
Width	76.6 mm / 3.014 inches
Height	27.6 mm / 1.087 inches
Depth	46 mm / 1.811 inches

### Mechanical Data

Variable coding	Yes
Anti-rotation protection	Yes

Subject to changes. Please also observe the further product documentation!



## Plug-in connection

Contact type (pluggable connector)	Male connector/plug
Connector (connection type)	for conductor
Mismatching protection	Yes
Plugging without loss of pin spacing	No
Locking of plug-in connection	Threaded flange

## Material Data

Note (material data)	Information on material specifications can be found here
Color	light gray
Material group	I
Insulation material	Polyamide (PA66)
Flammability class per UL94	V0
Clamping spring material	Chrome-nickel spring steel (CrNi)
Contact material	Electrolytic copper (E <sub>Cu</sub> )
Contact plating	Tin
Fire load	0.703 MJ
Weight	55 g

## Environmental requirements

Limit temperature range	-60 ... +105 °C
Processing temperature	-35 ... +60 °C

## Commercial data

ETIM 8.0	EC001284
ETIM 7.0	EC001284
PU (SPU)	12 pcs
Country of origin	PL
GTIN	4066966091588
Customs tariff number	85366990990



## Environmental Product Compliance

RoHS Compliance Status	Compliant, No Exemption
------------------------	-------------------------

Subject to changes. Please also observe the further product documentation!

## Approvals / Certificates

### General approvals

Logo	Approval	Additional Approval Text	Certificate name
	<b>CB</b> DEKRA Certification B.V.	IEC 61984	NL-61360 /M1
	<b>KEMA/KEUR</b> DEKRA Certification B.V.	EN 61984	71-116057
	<b>UR</b> Underwriters Laboratories Inc.	UL 1059	E45172

## Counterpart



Item no.831-3108/107-000

1-conductor female connector; Push-in CAGE CLAMP®; 10 mm<sup>2</sup>; Pin spacing 7.62 mm; 8-pole; 100% protected against mismatching; Screw flange; 10,00 mm<sup>2</sup>; light gray

[www.wago.com/831-3108/107-000](http://www.wago.com/831-3108/107-000)

## Downloads

### Documentation

#### Additional Information

Technical Section	2019 Apr 3	pdf	Download
Technical explanations		2.0 MB	

## CAD/CAE-Data

### CAD data

2D/3D Models 831-3208/109-000	URL	Download
-------------------------------	-----	----------

### CAE data

ZUKEN Portal 831-3208/109-000	URL	Download
-------------------------------	-----	----------

Subject to changes. Please also observe the further product documentation!

WAGO GmbH & Co. KG  
Hansastr. 27  
32423 Minden  
Phone: +49571 887-0 | Fax: +49571 887-169  
Email: [info.de@wago.com](mailto:info.de@wago.com) | Web: [www.wago.com](http://www.wago.com)

Do you have any questions about our products?  
We are always happy to take your call at +49 (571) 887-44222.

## Environmental Product Compliance

### Compliance Search

Environmental Product Compliance 831-3208/109-000

URL

Download

1-conductor male connector; Push-in CAGE CLAMP®; 10 mm<sup>2</sup>; Pin spacing 7.62 mm;  
8-pole; 100% protected against mismatching; Threaded flange; 10,00 mm<sup>2</sup>; light gray

## Installation Notes

### Conductor termination

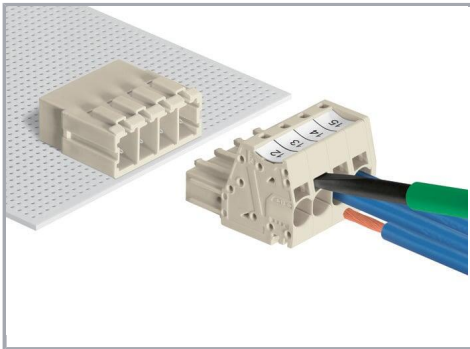

Inserting fine-stranded conductors via (5.5 x 0.8) mm screwdriver.

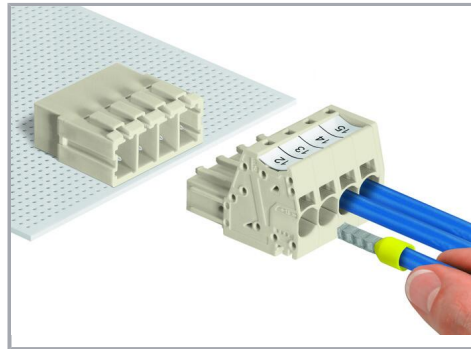

Solid and ferruled conductors are terminated by simply pushing them into unit.

### Testing

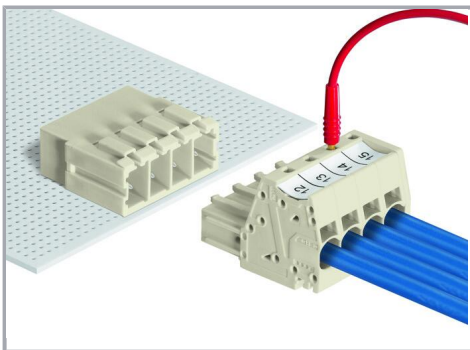

Testing with 2 mm Ø test plug.

### Coding

Subject to changes. Please also observe the further product documentation!

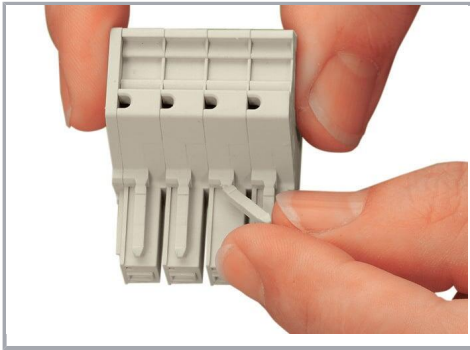

Break or cut off coding pin from female connector.

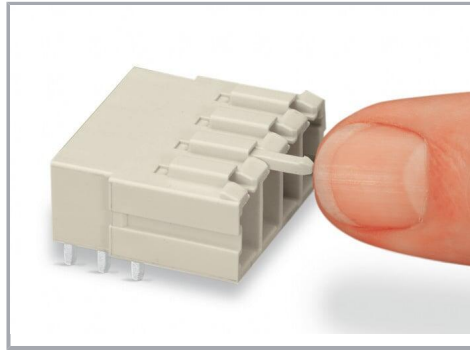

Insert coding pin into male header (break first) until it engages.

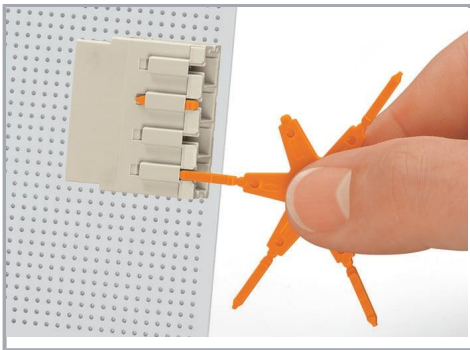

Coding a THT male header by inserting a coding pin.

### Marking



Direct marking of female and male connectors



MCS MAXI male and female connectors can also be marked via Mini-WSB or WMB markers.

### Product family

Subject to changes. Please also observe the further product documentation!





**MCS MAXI 6**

[Show all products from the family](#)

Subject to changes. Please also observe the further product documentation!

---

WAGO GmbH & Co. KG

Hansastr. 27

32423 Minden

Phone: +49571 887-0 | Fax: +49571 887-169

Email: [info.de@wago.com](mailto:info.de@wago.com) | Web: [www.wago.com](http://www.wago.com)

Do you have any questions about our products?

We are always happy to take your call at +49 (571) 887-44222.