

Data sheet | Item number: 890-242

Socket; 2-pole; Cod. B; 1,50 mm<sup>2</sup>; gray

[www.wago.com/890-242](http://www.wago.com/890-242)

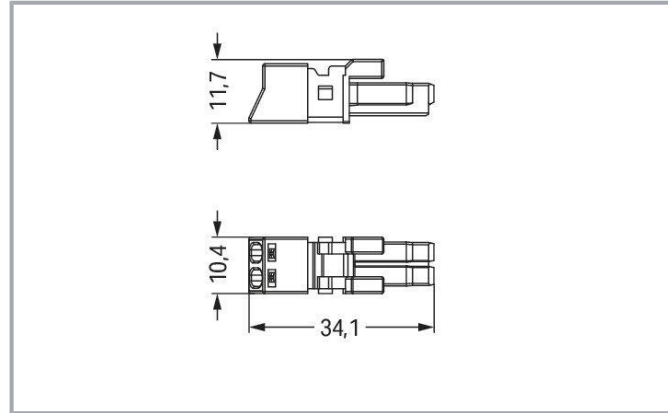
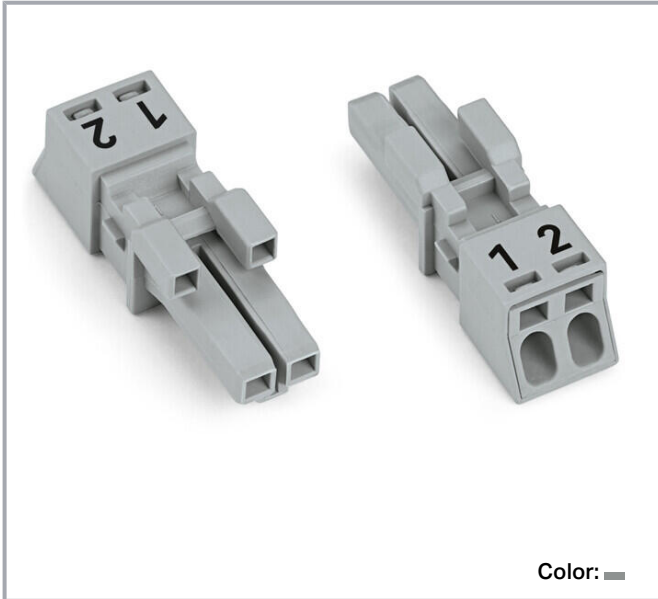

## Item description

### Female connector/socket *WINSTA*® MINI with protection type IP20

Use effective pluggable connections instead of laborious screw connections: With the *WINSTA*® MINI female connector/socket 2-pole. Our pluggable installation connectors with spring pressure connection technology work entirely without screw connections. They allow fast, efficient, error-free installation in a large number of applications. For greater security in electrical installations, the pluggable installation connector is equipped with mechanical protection against mismatching. Pluggable installation connectors with B coding from the *WINSTA*® MINI line are available in gray, light green, or pink, allowing you to distinguish different circuits, for example for light, pumps or, sun blinds. Customer-specific pole marking is possible as well. Thanks to its particularly compact dimensions, our *WINSTA*® MINI Pluggable Connection System with Push-in CAGE CLAMP® spring pressure connection technology is especially suitable in very tight spaces, i.e., for connections when very little room is available.

### Lower costs through fast commissioning and elimination of service expenses – solutions from *WINSTA*® MINI

*WINSTA*® is the pluggable connection system that is optimally tailored to the strict requirements of electrical installation. It allows fast, secure and, above all, error-free installation of components and cables. Choose quality and durability – the *WINSTA*® MINI pluggable installation connector with

Subject to changes. Please also observe the further product documentation!

WAGO GmbH & Co. KG  
Hansastr. 27  
32423 Minden  
Phone: +49571 887-0 | Fax: +49571 887-169  
Email: [info.de@wago.com](mailto:info.de@wago.com) | Web: [www.wago.com](http://www.wago.com)

Do you have any questions about our products?  
We are always happy to take your call at +49 (571) 887-44222.



protection type IP20 from WAGO makes the electrical installation of electrical components visibly easier.

- effective protection against mismatching
- easy tool-free operation, a wide range of coding options
- for automation controllers
- flexible installation to save space
- convenient installation and commissioning

## Data Notes

Variants: Other pole markings  
Other versions (or variants) can be requested from WAGO Sales or configured at <https://configurator.wago.com/>.

## Electrical data

### Ratings per IEC/EN

Ratings per	IEC/EN 60664-1
Nominal voltage (III/3)	250 V
Rated impulse voltage (III/3)	4 kV
Rated current	16 A
Legend (ratings)	(III / 3) ≙ Overvoltage category III / Pollution degree 3

### Ratings per UL 1977

Note for the US market	Some versions may also be used for current interruption in accordance with the UL certificate in select applications with currents below 5 A and voltages up to 600 V. For further information, please contact your local sales office.
Rated voltage (UL 1977)	600 V
Rated current UL 1977	14 A

## General

Note on contact resistance	approx. 1 mΩ of contact resistance approx. 0.25 mΩ contact transition plug/socket
----------------------------	--

Subject to changes. Please also observe the further product documentation!



## Connection data

Connection points	2
Total number of potentials	2

## Connection 1

Connection technology	Push-in CAGE CLAMP®
Actuation type	Operating tool Push-in
Nominal cross-section	1.5 mm <sup>2</sup> / 16 AWG
Solid conductor	0.25 ... 1.5 mm <sup>2</sup> / 22 ... 16 AWG
Solid conductor; push-in termination	0.75 ... 1.5 mm <sup>2</sup> / 20 ... 16 AWG
Stranded conductor	0.25 ... 1 mm <sup>2</sup> / 22 ... 18 AWG
Fine-stranded conductor	0.25 ... 1.5 mm <sup>2</sup> / 22 ... 16 AWG
Fine-stranded conductor; with insulated ferrule	0.25 ... 0.75 mm <sup>2</sup> / 22 ... 20 AWG
Fine-stranded conductor; with uninsulated ferrule	0.25 ... 0.75 mm <sup>2</sup> / 22 ... 20 AWG
Fine-stranded conductor; with ferrule; push-in termination	0.75 mm <sup>2</sup> / 20 AWG
Strip length	9 mm / 0.35 inches
Pole number	2
Conductor entry direction to mating direction	0°

## Physical data

Pin spacing	4.4 mm / 0.173 inches
Width	10.4 mm / 0.409 inches
Height	11.7 mm / 0.461 inches
Depth	34.1 mm / 1.343 inches

## Mechanical Data

Application	Control technology
Coding	B
Variable coding	No
Marking	1 2
Potential marking	1 2
Mating force of a plug-in connection	approx. 20 ... 70 N (depending on pole number)
Retention force of a plug-in connection	Locked: > 80 N
Unmating force of a plug-in connection	Unlocked: approx. 20 ... 70 N (depending on pole number)

Subject to changes. Please also observe the further product documentation!



Number of mating cycles	200, without resistive load
Protection type	IP20; IP40 with strain relief housing

### Plug-in connection

Contact type (pluggable connector)	Female connector/socket
Connector (connection type)	for conductor
Mismating protection	Yes
Note on mismating protection	All <i>WINSTA</i> <sup>®</sup> components are 100% protected against mismating when: a.) plugging different numbers of poles b.) plugging while rotated 180 c.) plugging while laterally staggered d.) plugging one pole
Locking lever	Can be retrofitted
Locking of plug-in connection	locking lever
Note on locking system	All connectors for mounted installations (snap-in versions for lighting fixtures or devices, all types of PCB and distribution connectors) are factory-equipped with locking levers to ensure plugs and sockets are securely locked. Additional locking levers are only required for flying leads (plug/socket).

### Material Data

Note (material data)	Information on material specifications can be found here
Color	gray
Cover color	gray
Material group	I
Insulation material	Polyamide (PA66)
Flammability class per UL94	V0
Clamping spring material	Chrome-nickel spring steel (CrNi)
Contact material	Copper or copper alloy; surface-treated
Contact plating	Tin
Fire load	0.058 MJ
Weight	2.6 g

### Environmental requirements

Processing temperature	-5 ... +40 °C
Continuous operating temperature	-35 ... +85 °C

Subject to changes. Please also observe the further product documentation!

Note on continuous operating temperature

Insulating parts for temperatures  $\leq 105\text{ }^{\circ}\text{C}$ 

## Commercial data

Product Group	20 (Winsta)
eCl@ss 10.0	27-44-06-05
eCl@ss 9.0	27-44-06-05
ETIM 8.0	EC002560
ETIM 7.0	EC002560
PU (SPU)	50 pcs
Packaging type	box
Country of origin	PL
GTIN	4055143499583
Customs tariff number	85366990990



## Environmental Product Compliance

RoHS Compliance Status

Compliant, No Exemption

## Approvals / Certificates

### General approvals

Logo	Approval	Additional Approval Text	Certificate name
	CB DEKRA Certification B.V.	EN 61984	71-112993
	CB DEKRA Certification B.V.	IEC 61984	NL-64351
	cURus Underwriters Laboratories Inc.	UL 1977	E45171
	KEMA/KEUR DEKRA Certification B.V.	EN 60320	2148952.04

## Declarations of conformity and manufacturer's declarations

Logo	Approval	Additional Approval Text	Certificate name
	EU-Declaration of Conformity	-	-

Subject to changes. Please also observe the further product documentation!





WAGO GmbH &amp; Co. KG









UK-Declaration of Conformity

WAGO GmbH &amp; Co. KG

## Approvals for marine applications

Logo	Approval	Additional Approval Text	Certificate name
	<b>DNV GL</b> Det Norske Veritas, Germanischer Lloyd	-	TAE00001Z6
	<b>LR</b> Lloyds Register	EN 61535	08/20047 (E2)

## Counterpart

	<b>Item no.890-1601</b> T-distribution connector; 2-pole; Cod. B; 1 input; 2 outputs; 2 locking levers; gray	<a href="http://www.wago.com/890-1601">www.wago.com/890-1601</a>
	<b>Item no.890-1701</b> T-distribution connector; 2-pole; Cod. B; 1 input; 2 outputs; 3 locking levers; for flying leads; gray	<a href="http://www.wago.com/890-1701">www.wago.com/890-1701</a>
	<b>Item no.890-252</b> Plug; 2-pole; 1,50 mm <sup>2</sup> ; gray	<a href="http://www.wago.com/890-252">www.wago.com/890-252</a>
	<b>Item no.890-752</b> Snap-in plug; 2-pole; Cod. B; 1,50 mm <sup>2</sup> ; gray	<a href="http://www.wago.com/890-752">www.wago.com/890-752</a>
	<b>Item no.890-852</b> Plug for PCBs; straight; 2-pole; Cod. B; gray	<a href="http://www.wago.com/890-852">www.wago.com/890-852</a>
	<b>Item no.890-852/011-000</b> Plug for PCBs; angled; 2-pole; Cod. B; gray	<a href="http://www.wago.com/890-852/011-000">www.wago.com/890-852/011-000</a>
	<b>Item no.891-8992/005-103</b> pre-assembled interconnecting cable; Eca; Socket/plug; 2-pole; Cod. B; Control cable 2 x 1.0 mm <sup>2</sup> ; 1 m; 1,00 mm <sup>2</sup> ; gray	<a href="http://www.wago.com/891-8992/005-103">www.wago.com/891-8992/005-103</a>

Subject to changes. Please also observe the further product documentation!

WAGO GmbH & Co. KG  
 Hansastr. 27  
 32423 Minden  
 Phone: +49571 887-0 | Fax: +49571 887-169  
 Email: [info.de@wago.com](mailto:info.de@wago.com) | Web: [www.wago.com](http://www.wago.com)

Do you have any questions about our products?  
 We are always happy to take your call at +49 (571) 887-44222.



Item no.891-8992/205-103

pre-assembled connecting cable; Eca; Plug/open-ended; 2-pole; Cod. B; Control cable 2 x 1.0 mm<sup>2</sup>; 1 m; 1,00 mm<sup>2</sup>; gray

[www.wago.com/891-8992](http://www.wago.com/891-8992)

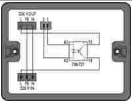

Item no.899-632/102-000

Distribution box; Relay switching; 2 inputs; 1 output; Cod. A, B; MINI, MIDI

[www.wago.com/899-632/102-000](http://www.wago.com/899-632/102-000)

## Required accessories

### Locking levers

#### Locking system



Item no.: 890-111

Locking lever; for flying leads; for tool operation; black

[www.wago.com/890-111](http://www.wago.com/890-111)



Item no.: 890-101

Locking lever; for manual operation; black

[www.wago.com/890-101](http://www.wago.com/890-101)



Item no.: 890-121

Locking lever; for manual operation; white

[www.wago.com/890-121](http://www.wago.com/890-121)



Item no.: 890-131

Locking lever; for flying leads; for tool operation; white

[www.wago.com/890-131](http://www.wago.com/890-131)

### Strain relief

#### Strain relief housing



Item no.: 890-502

Strain relief housing; 2-pole; with locking clip; for 1 cable; 3.8 ... 8.2 mm; 30 mm; black

[www.wago.com/890-502](http://www.wago.com/890-502)



Item no.: 890-502/342-000

Strain relief housing; 2-pole; with locking clip; for 1 cable; 3.8 ... 8.2 mm; 17.5 mm; black

[www.wago.com/890-502/342-000](http://www.wago.com/890-502/342-000)



Item no.: 890-512

Strain relief housing; 2-pole; with locking clip; for 1 cable; 3.8 ... 8.2 mm; 30 mm; white

[www.wago.com/890-512](http://www.wago.com/890-512)



Item no.: 890-512/342-000

Strain relief housing; 2-pole; with locking clip; for 1 cable; 3.8 ... 8.2 mm; 17.5 mm; white

[www.wago.com/890-512/342-000](http://www.wago.com/890-512/342-000)

## Optional accessories

### Cover

#### Cover

Subject to changes. Please also observe the further product documentation!

WAGO GmbH & Co. KG

Hansastr. 27

32423 Minden

Phone: +49571 887-0 | Fax: +49571 887-169

Email: [info.de@wago.com](mailto:info.de@wago.com) | Web: [www.wago.com](http://www.wago.com)

Do you have any questions about our products?

We are always happy to take your call at +49 (571) 887-44222.



**Item no.: 897-2001**  
Protective cap; Type1; for sockets and plugs; PVC; red

[www.wago.com/897-2001](http://www.wago.com/897-2001)

## Mounting

### Mounting accessories



**Item no.: 890-310**  
Mounting carrier; 2- to 5-pole; for flying leads; black

[www.wago.com/890-310](http://www.wago.com/890-310)



**Item no.: 890-311**  
Mounting carrier; 2- to 5-pole; for flying leads; white

[www.wago.com/890-311](http://www.wago.com/890-311)

## Tool

### Operating tool



**Item no.: 210-719**  
Operating tool; Blade: 2.5 x 0.4 mm; with a partially insulated shaft

[www.wago.com/210-719](http://www.wago.com/210-719)



**Item no.: 890-382**  
Operating tool; 2-way; green

[www.wago.com/890-382](http://www.wago.com/890-382)

## Downloads

### Documentation

#### Bid Text

890-242 X81 - Datei	2019 Feb 19	xml 3.0 kB	Download
890-242 doc - Datei	2015 Jun 8	doc 23.6 kB	Download

### CAD/CAE-Data

#### CAE data

EPLAN Data Portal 890-242	URL	Download
WSCAD Universe 890-242	URL	Download
ZUKEN Portal 890-242	URL	Download

Subject to changes. Please also observe the further product documentation!

WAGO GmbH & Co. KG  
Hansastr. 27  
32423 Minden  
Phone: +49571 887-0 | Fax: +49571 887-169  
Email: [info.de@wago.com](mailto:info.de@wago.com) | Web: [www.wago.com](http://www.wago.com)

Do you have any questions about our products?  
We are always happy to take your call at +49 (571) 887-44222.



## CAD data

2D/3D Models 890-242

[URL](#)

[Download](#)

## Environmental Product Compliance

### Compliance Search

Environmental Product Compliance 890-242

[URL](#)

[Download](#)

Socket; 2-pole; Cod. B; 1,50 mm<sup>2</sup>; gray

## Installation Notes

### Conductor termination

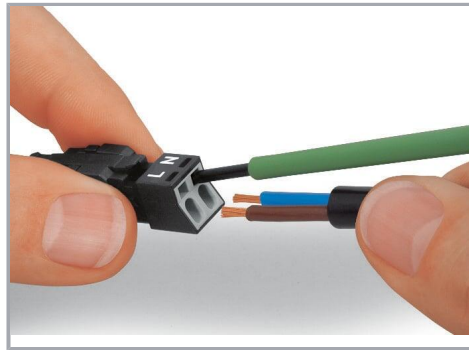
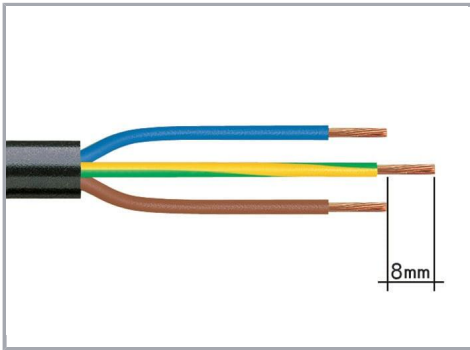

1. Strip length, outer insulation = 30 mm (2-pole), 37 mm (3-pole), 45 mm (4- and 5-pole)

2. Strip length = 9 mm

3. Extended ground conductor = 8 mm

To terminate fine-stranded conductors, open the clamping unit via screwdriver – 2.5 mm blade width – and insert a stripped conductor until it hits the backstop. Terminate solid conductors by simply pushing them in.

Subject to changes. Please also observe the further product documentation!

WAGO GmbH & Co. KG

Hansastr. 27

32423 Minden

Phone: +49571 887-0 | Fax: +49571 887-169

Email: [info.de@wago.com](mailto:info.de@wago.com) | Web: [www.wago.com](http://www.wago.com)

Do you have any questions about our products?

We are always happy to take your call at +49 (571) 887-44222.

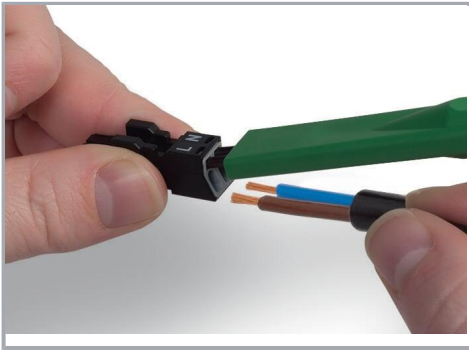

To terminate fine-stranded conductors, open clamping units via operating tool (890-382) and insert stripped conductors until they hit backstop.

Terminate solid conductors by simply pushing them in.

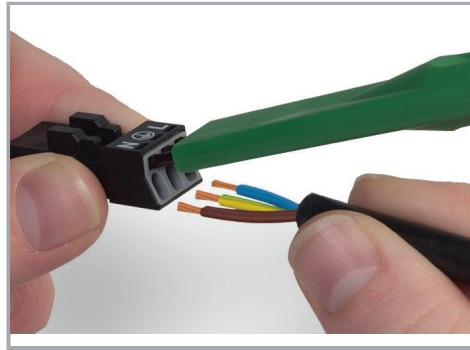

To terminate fine-stranded conductors, open clamping units via operating tool (890-383) and insert stripped conductors until they hit backstop.

Terminate solid conductors by simply pushing them in.

#### Installation

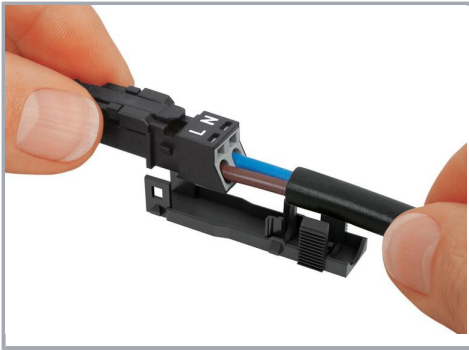

Latch the wired connector into the base of the strain relief housing.

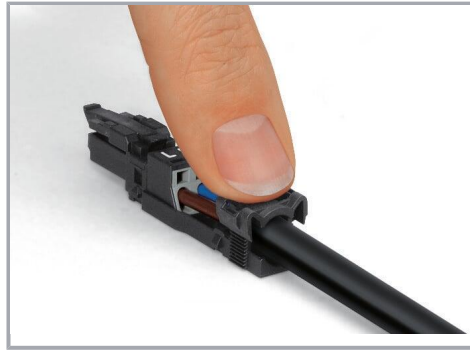

Push down strain relief clamp by hand.

Subject to changes. Please also observe the further product documentation!



Push down strain relief clamp with 2.5 mm screwdriver alternately on both sides.

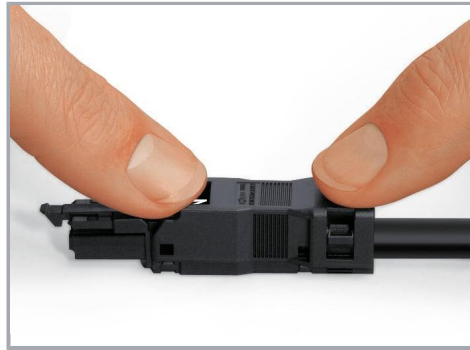

Latch the top of the strain relief housing.



The printed marking of the connector is clearly visible in the openings of the strain relief housing.

#### Mismatching protection

Subject to changes. Please also observe the further product documentation!

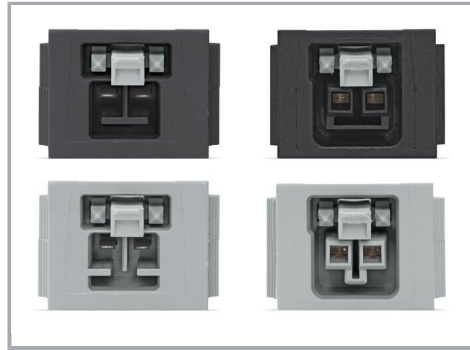
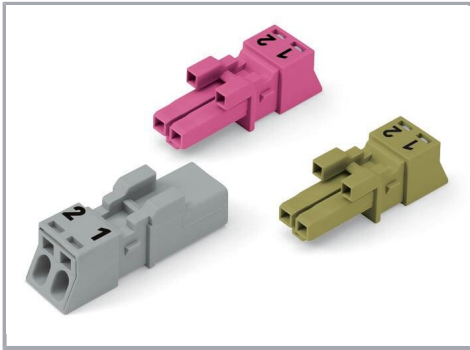

B-coded connectors with different colors can be plugged together.

**Important note:**

Different colors and/or pole markings are used for circuit identification.

Only connectors of the same color and same pole marking must be plugged together.

B-coded connectors (shown in gray) not only differ in color, but also in their design, making them incompatible with other coded connectors.



**Product family**

**WINSTA® MINI**

[Show all products from the family](#)

Subject to changes. Please also observe the further product documentation!