

SPECIFICATIONS

PARAMETERS	VALUES	UNITS
RATED INPUT POWER	3	W
MAX INPUT POWER	5	W
IMPEDANCE	8± 15%	OHM
AVG. SPL 1W/0.1M ON 4MM THICK PLA PANEL (AT 0.5, 1.0, 2.0, 5.0 kHz)	83	dBa
RESONANT FREQUENCY	450± 20%	Hz
FREQUENCY RANGE	Fo~ 10,500	Hz
MAGNET MATERIAL	NdFeB	-
OPERATING TEMPERATURE	-20~ +60	°C
WEIGHT	28.6	grams

THIS DOCUMENT CONTAINS DATA PROPRIETARY TO PROJECTS UNLIMITED, INC. ANY USE OR REPRODUCTION, IN ANY FORM, WITHOUT PRIOR WRITTEN PERMISSION OF PROJECTS UNLIMITED, INC. IS PROHIBITED.
©2003, Projects Unlimited Inc.

REVISION HISTORY

LTR	DESCRIPTION	DATE	APPROVED
-	RELEASED FROM ENGINEERING	5/18/16	
A	ADDED NOTE 4	6/27/16	B.R.

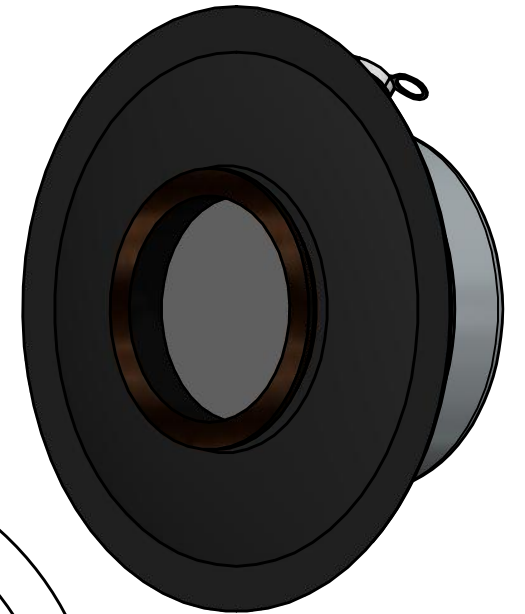
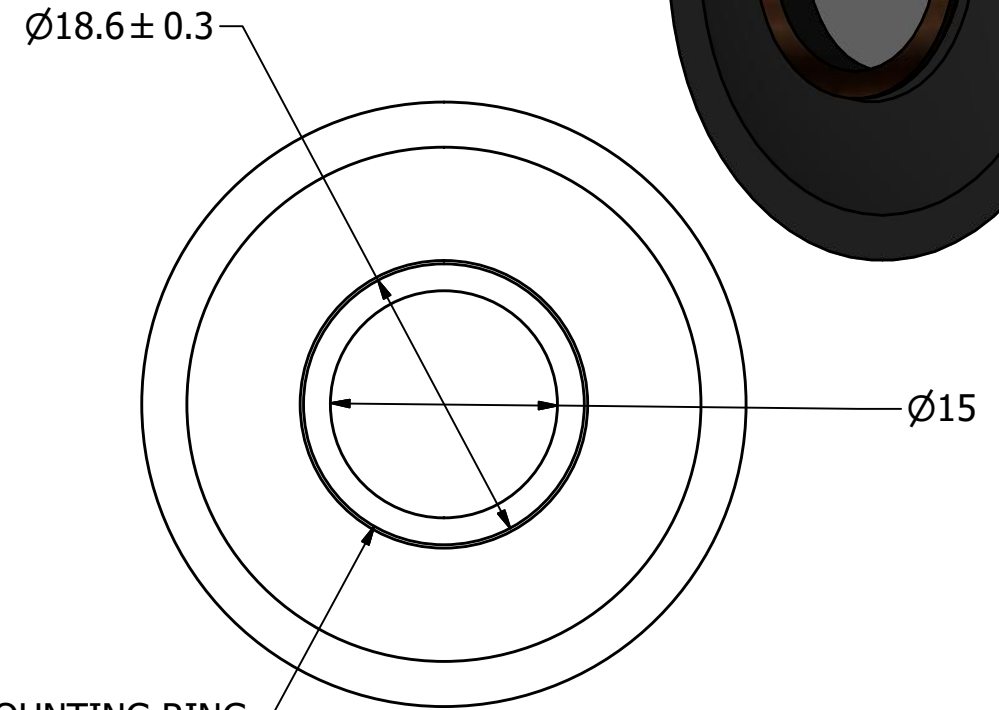
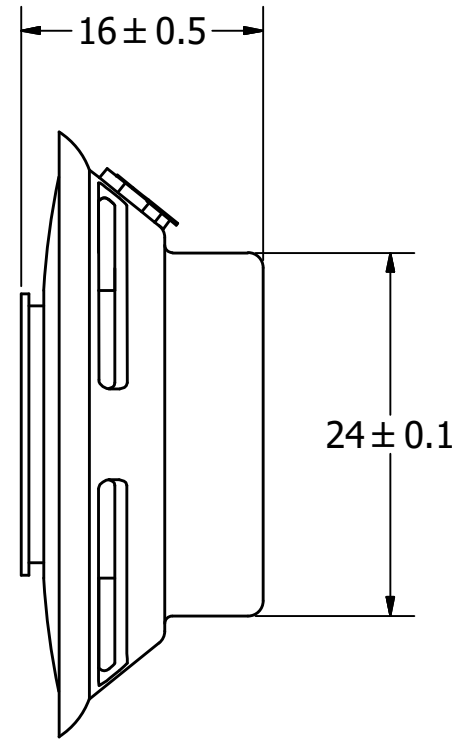
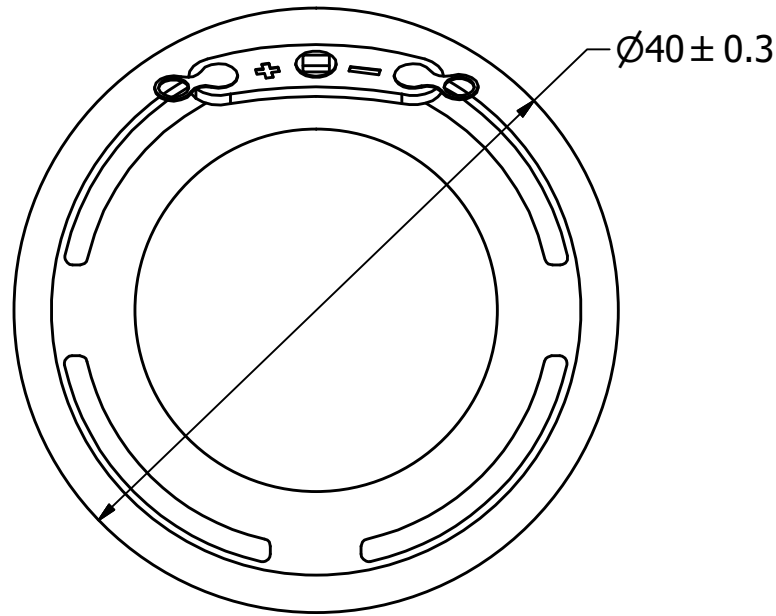

MOUNTING RING
3M™ VHB™ DOUBLE-SIDED TAPE

NOTES:

1. ALL DIMENSIONS ARE IN MILLIMETERS.
2. SPECIFICATIONS SUBJECT TO CHANGE OR WITHDRAWL WITHOUT NOTICE.
3. THIS PART IS RoHS 2011/65/EU COMPLIANT.
4. FOR APPLICATIONS THAT ARE TO BE SUBJECTED TO EXTERNAL FORCE, SHOCK, OR VIBRATION, PUI AUDIO RECOMMENDS SOLID MECHANICAL REINFORCEMENT TO ENSURE RIGID COUPLING BEYOND THAT PROVIDED BY THE 3M™ VHB™ F-9473PC DOUBLE-SIDED TAPE.

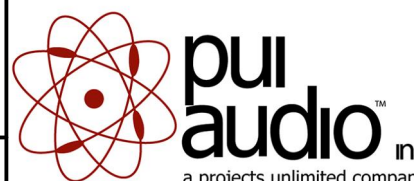
UNLESS OTHERWISE SPECIFIED: DIMENSIONS ARE IN MILLIMETERS, TOLERANCES ARE ±0.5 AND ANGLES ARE ±3°.	SIZE A3	Designed by	Date	Checked by	Date	Approved by	Date	Drawn Date
		M.V.	5/18/2016	M.V.	5/18/2016	B.R.	5/18/2016	5/18/2016
ASX04008-R.idw				ASX04008-R				
				Exciter			Edition	Sheet
							-	1 / 1