

# EMI/EMC FILTER

RoHS

## ID SERIES

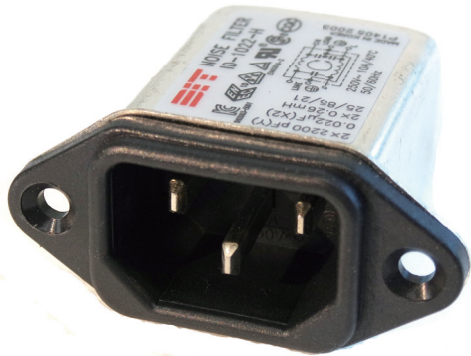

### Features

- Ideally suited for products that must conform to part 15, FCC regulations
- Metal cased miniature type with high performance
- Meet over voltage category II of IEC 60664 and comply with IEC 60950
- Uses IEC connector that meets the safety standards from certification bodies
- Both soldering lug type and faston tab type are available

### Applications

- Digital equipments
- Personal computers and peripherals
- Measuring instruments
- For use in miniature equipments
- For monitors and display units

## Specifications

Model	Rated Voltage (AC, DC)	Rated Current	Leakage Current (250V AC)	Operating Temperature
ID-0242*	250V (50/60Hz)	2A	0.35mA max.	-25°C to +85°C Including temperature rise Derating Curve 
ID-0342*		3A		
ID-0642*		6A		
ID-1022*		10A		
ID-15A2*		15A		

**Note**

Test Voltage : 1500V AC one minute, line to earth  
 Insulation Resistance : 300 Mohm min. at 500V DC  
 Voltage Drop : 1V max. at rated current  
 Weight : 45g

## Model Number Construction

I	D	03	4	2	S
Input Connector I : IEC Connector	Special Design D : Screw mounting/ Metal Case	Current Rating : AC rms 01,N01 : 1amp 02,N02 : 2amp 03,N03,L03 : 3amp 06,N06 : 6amp N08 : 8amp L10 : 10amp 15,N15 : 15amp ("L","N" high performance)	Line-Line Cap.Value 2 : 0.022 $\mu$ F 4 : 0.047 $\mu$ F A : 0.1 $\mu$ F B : 0.15 $\mu$ F	Line-Gnd Cap.Value 1 : 1500 pF 2 : 2200 pF 3 : 3300 pF C : 330 pF D : 470 pF E : 1000 pF O : None	Output Terminal S : Solder Lug H : Faston Tab #250

# Shapes and Dimensions

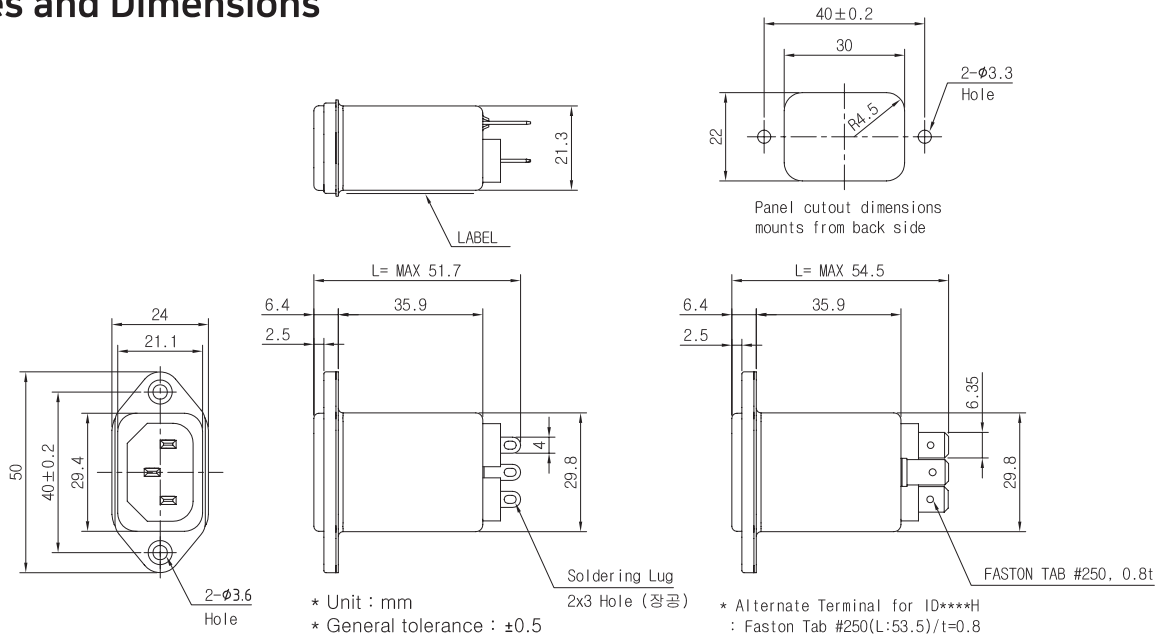

# Attenuation Characteristics

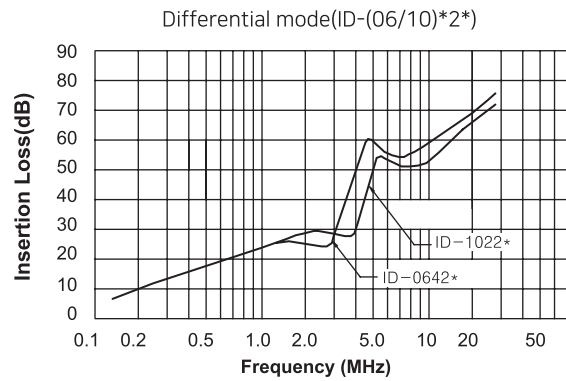
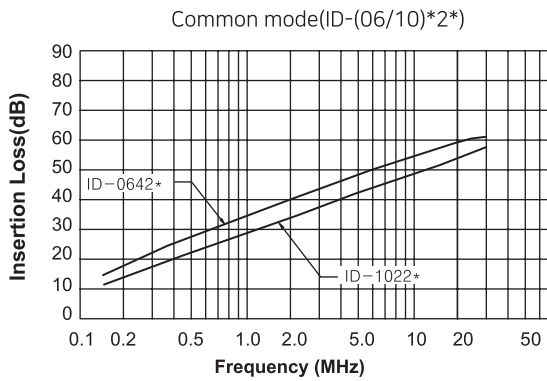
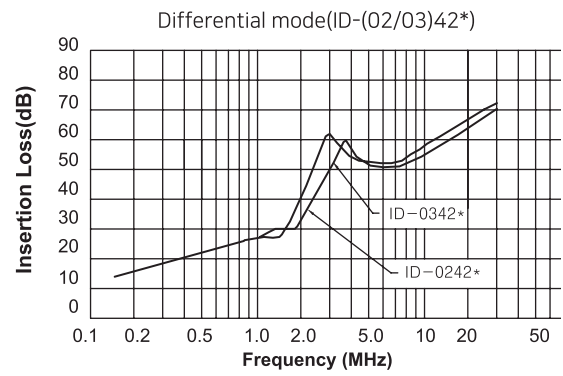
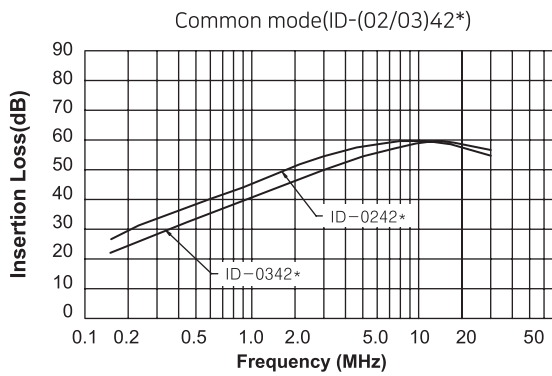

# Circuit Diagram

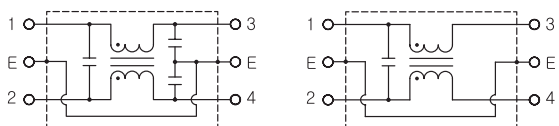

ID-\*\*\*\*-\* type

ID-\*\*\*0-\* type

# Measurement Configuration

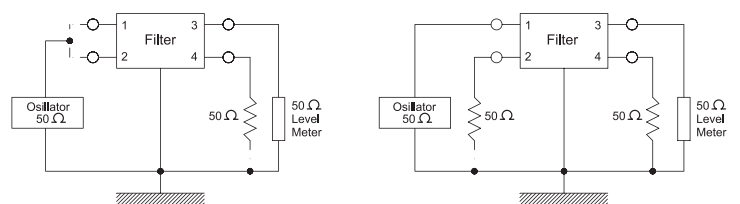

Common mode

Differential mode