

IS31FL3801

Smart Integrated Matrix LED Driver with Touch Key Controller

GENERAL DESCRIPTION

The IS31FL3801 is a general purpose 16x8 or 15x9 LED Matrix programmed via 1MHz I2C compatible interface. Each LED can be dimmed individually with 8-bit PWM data, and each CSx has 8-bit DC scaling (Color Calibration) data which allowing 256 steps of linear PWM dimming for each dot and 256 steps of DC current adjustable level for each CSx.

Additionally each LED open and short state can be detected, IS31FL3801 store the open or short information in Open-Short Registers. The Open-Short Registers allowing MCU to read out via I2C compatible interface. Inform MCU whether there are LEDs open or short and the locations of open or short LEDs.

An eleven-channel capacitive touch controller is integrated with on-chip calibration logic which continuously monitors the environment and automatically adjusts the threshold levels to prevent false triggers.

An on-chip I²C slave controller with 400kHz capability and programmable slave addresses serves as the communication port for the host MCU. An interrupt, INTB, can be configured so it is generated when a trigger event (touched or released) occurs. Trigger or clear condition can be configured by setting the interrupt register.

IS31FL3801 is available in RoHS compliant package QFN-60 (7mmx7mm). It operates from 2.7V to 5.5V over the temperature range of -40°C to +105°C.

FEATURES

- ◆ Matrix LED Driver
 - Supply voltage range: 2.7V to 5.5V
 - 16 current sinks
 - Support 16xn (n=1~8), 15x9 LED matrix configurations
 - Individual 256 PWM control steps
 - 256 DC current steps for each CSx
 - 64 global current steps
 - SDB rising edge reset I2C module
 - 32kHz PWM frequency
 - 1MHz I2C-compatible interface
 - Individual open and short error detect function
 - PWM 180 degree phase shift
 - Spread spectrum
 - De-ghost
- ◆ Capacitive Touch Sensor
 - Capacitive touch controller with readable key value through shared GPIO
 - Individual sensitivity threshold setting for each touch key
 - Optional multiple-key function
 - Press and hold function
 - Automatic calibration
 - Individual key calibration
 - Interrupt output with auto-clear and repeating
 - Auto sleep mode for extremely low power
 - Key wake up from sleep mode
- ◆ 400kHz fast-mode I²C interface
- ◆ Provides Spread
- ◆ Operating temperature between -40°C ~ +105°C
- ◆ QFN-60 package

APPLICATIONS

- ◆ Home appliance touch control keys
- ◆ Industrial applications
- ◆ Gaming devices
- ◆ IoT devices

IS31FL3801

BLOCK DIAGRAM

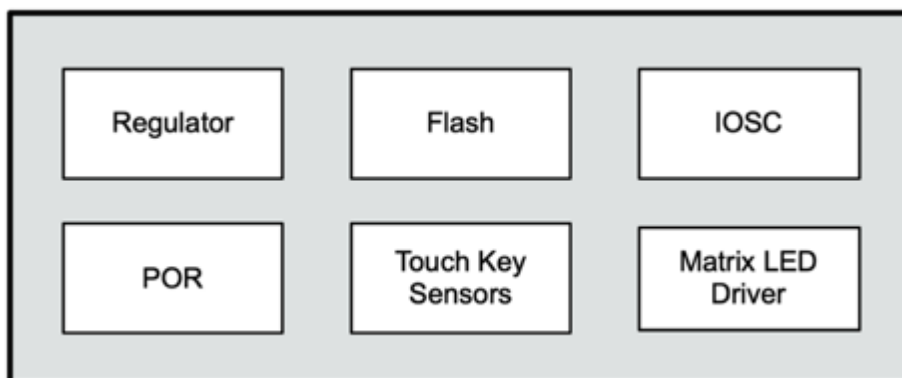

Block Diagram of IS31FL3801

IS31FL3801

PACKAGE TYPE

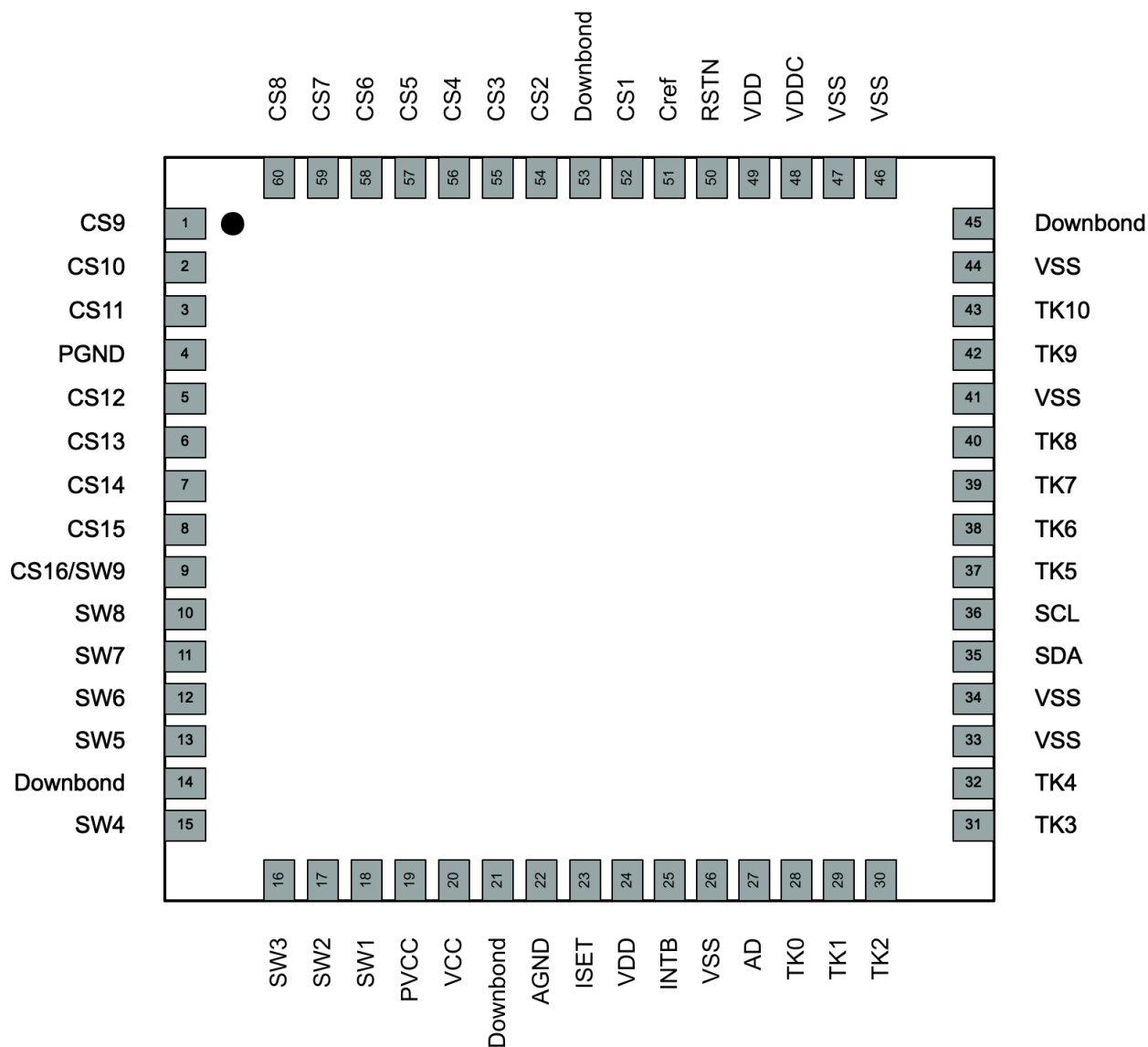

IS31FL3801

PIN CONFIGURATION

No.	Pin	Description
23	ISET	An external resistor to ground is required for setting the LED current
1-3, 5-8, 52, 54-60	CS1-CS15	Current sinks for LED matrix
4, 14, 21, 22, 26, 33, 34, 41, 44-47, 53	VSS	Ground connection
19, 20, 24, 49	VDD	Power supply. Typical decoupling capacitors of 0.1uF and 10uF should be connected between VDD and VSS
25	INTB	Interrupt output, active low.
27	AD	I2C address setting.
28-32,37-40,42-43	KEY0-KEY10	Input sense channel 0 -10
35	SDA	I2C data, need to pull up with 4.7K resistor
36	SCL	I2C clock, need to pull up with 4.7K resistor
48	VDDC	Internal regulator output around 1.8V. Typical decoupling capacitors of 0.1uF and 10uF should be connected between VDDC and VSS
50	RSTN	Low active. A resistor to VDD and a capacitor to VSS are typically connected. RSTN is pulled low when LVR occurs. The threshold of RSTN is set at 0.3VDD. RSTN is also used for special test mode and writer mode entry.
51	C _{REF}	External capacitor must be connected for touch key controller.
10-13, 15-18	SW8-SW1	Power SW.
9	CS16/SW9	Current sinks for LED matrix CS16 or power switch SW9

IS31FL3801

ORDERING INFORMATION

Industrial Range: -40°C to +105°C

Order Part No.	Package	QTY
IS31FL3801-QFLS3-TR	QFN-60, Lead-free	2500

Copyright © 2020 Lumissil Microsystems. All rights reserved. Lumissil Microsystems reserves the right to make changes to this specification and its products at any time without notice. Lumissil Microsystems assumes no liability arising out of the application or use of any information, products or services described herein. Customers are advised to obtain the latest version of this device specification before relying on any published information and before placing orders for products.

Lumissil Microsystems does not recommend the use of any of its products in life support applications where the failure or malfunction of the product can reasonably be expected to cause failure of the life support system or to significantly affect its safety or effectiveness. Products are not authorized for use in such applications unless Lumissil Microsystems receives written assurance to its satisfaction, that:

- a.) the risk of injury or damage has been minimized;
- b.) the user assume all such risks; and
- c.) potential liability of Lumissil Microsystems is adequately protected under the circumstances

IS31FL3801

TYPICAL APPLICATION CIRCUIT (QFN-60)

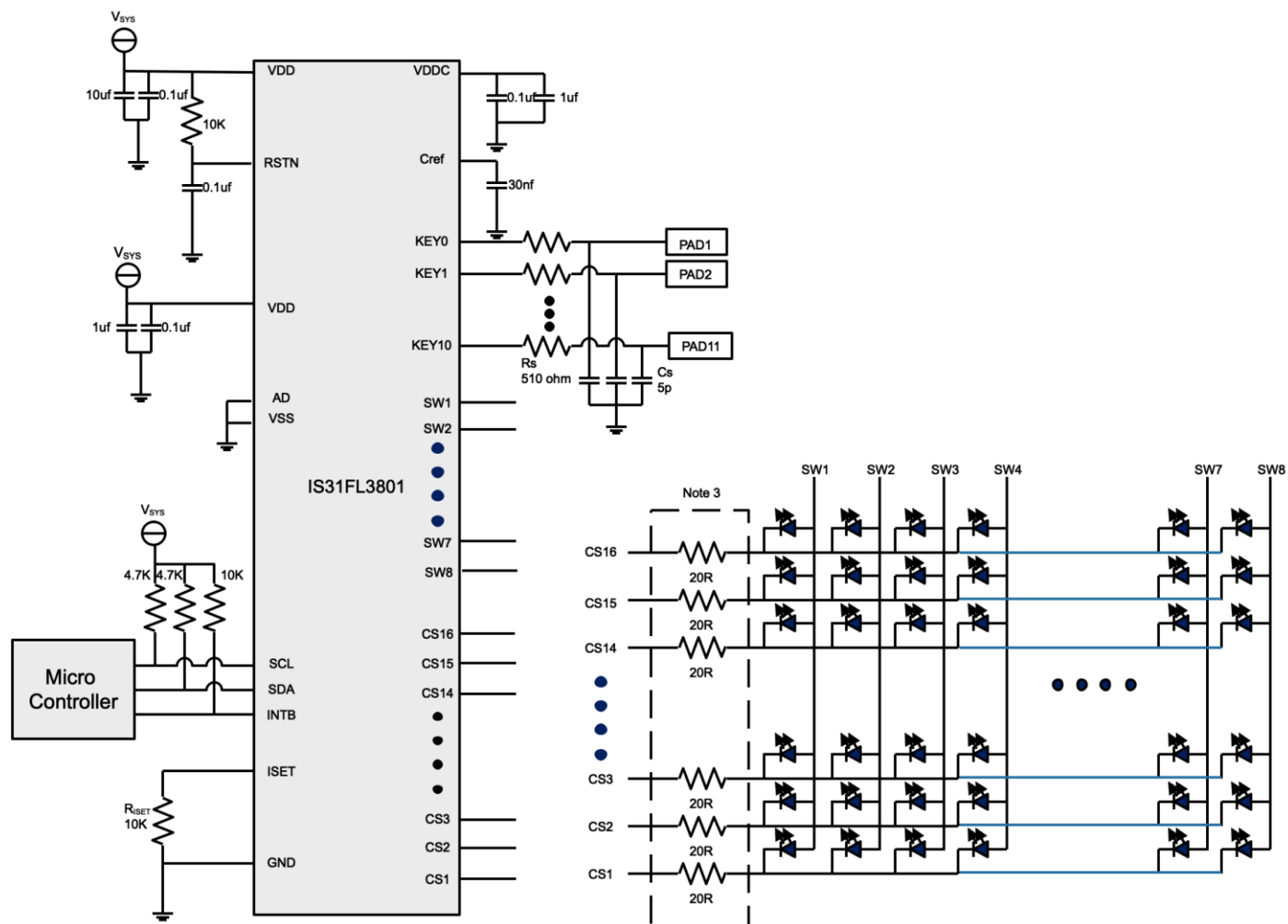

Figure 1 Typical Application Circuit (QFN-60)

Note 1: The chip should be placed far away from the noise points in order to prevent the EMI.

Note 2: The R_s and C_s should place as close to the chip as possible to reduce EMI.

IS31FL3801

1. DETAILED DESCRIPTION

1.1 IS31FL3801 GUI

IS31FL3801 GUI is a windows-based Integrated Design Environment (IDE). User can use it to develop touch key applications without firmware coding. With the GUI user can design the touch key system easily. With the GUI you can:

1. Monitor the Key value
2. Set touch threshold and enable keys
3. Switch the operating modes
4. Tune System parameters
5. Touch Key and GPIO Configuration
6. Matrix LED demo
7. Set Slider Electrodes

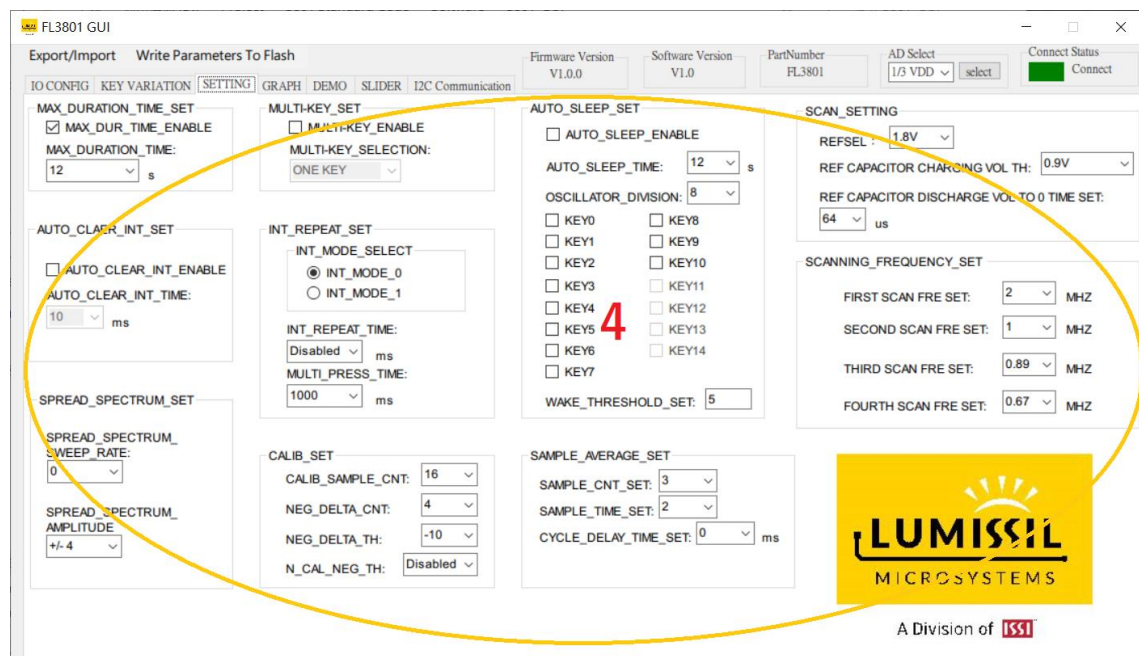
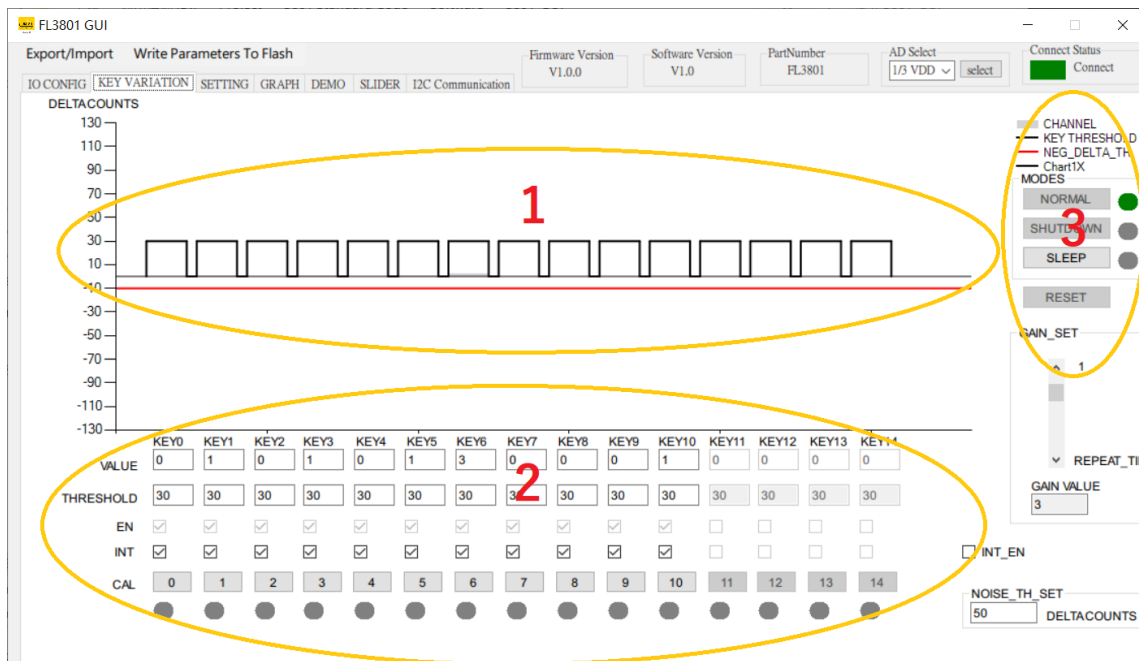

IS31FL3801

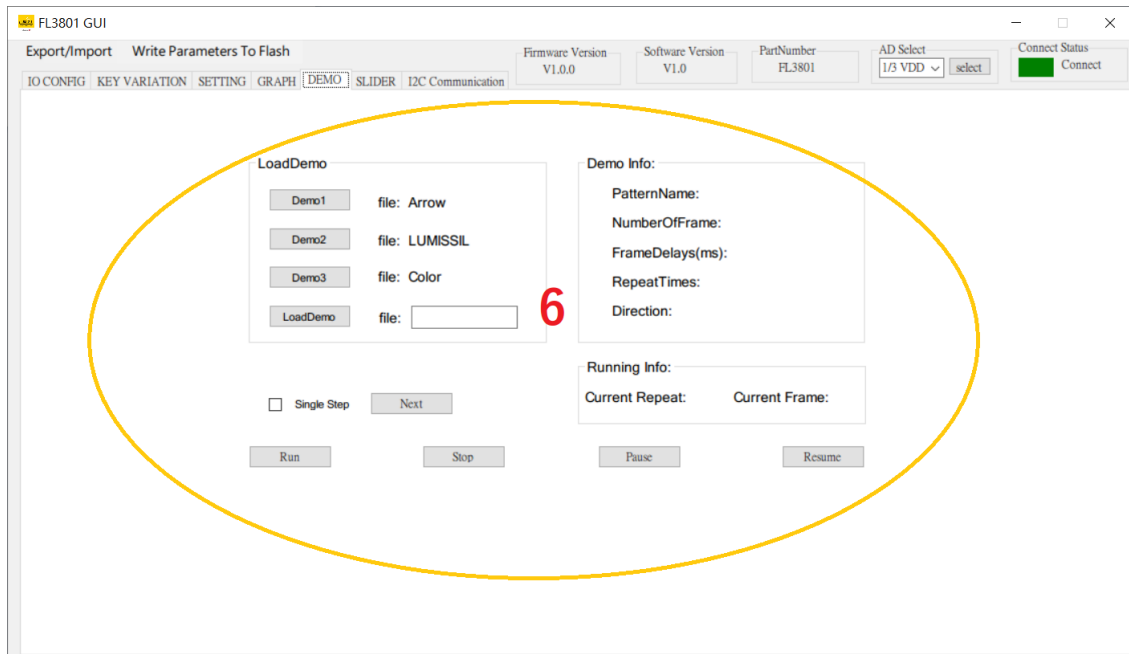
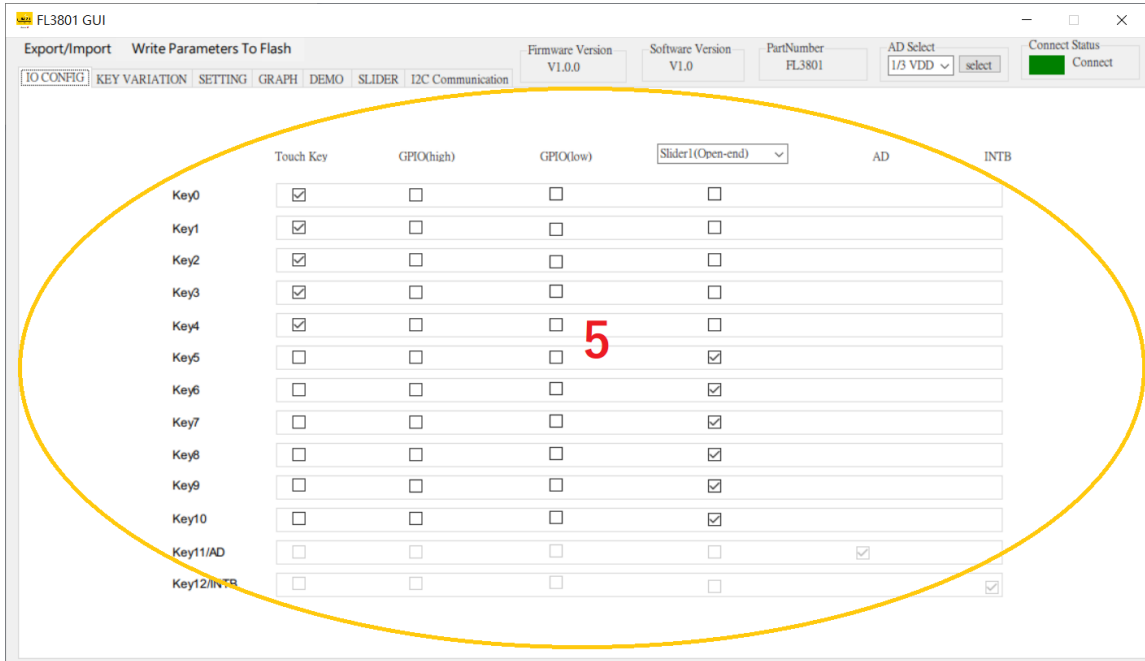

IS31FL3801

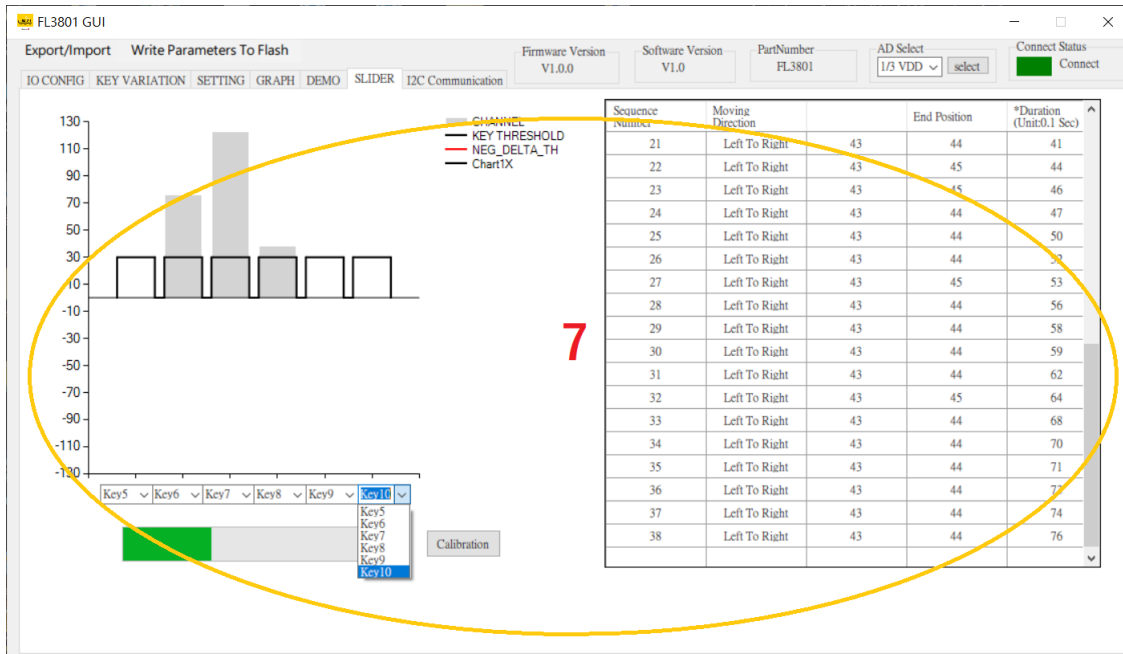

Please refer to the User's Guide for other details.

IS31FL3801

ABSOLUTE MAXIMUM RATINGS

Supply voltage, VCC (for LED driving)	-0.3V ~ +6.0V
Supply voltage, VDD	+5.5V
Voltage at any input pin	-0.3V ~ VCC+0.3V
Maximum junction temperature, T _{JMAX}	+150°C
Storage temperature range, T _{STG}	-65°C ~ +150°C
Operating temperature range, T _A =T _J	-40°C ~ +105°C
Junction Package thermal resistance, junction to ambient (4 layer standard test PCB based on JESD 51-2A), θ_{JA}	35°C/W
ESD (HBM)	±2kV
ESD (CDM)	±750V

Note 4: Stresses beyond those listed under “Absolute Maximum Ratings” may cause permanent damage to the device. These are stress ratings only and functional operation of the device at these or any other condition beyond those indicated in the operational sections of the specifications is not implied. Exposure to absolute maximum rating conditions for extended periods may affect device reliability.

1.2 ELECTRICAL CHARACTERISTICS

T_A = 25°C, V_{DD} = 2.7V ~ 5.5V, unless otherwise noted. Typical value are T_A = 25°C, V_{DD} = 5V.

Symbol	Parameter	Condition	Min.	Typ.	Max.	Unit
V _{DD}	Supply voltage		2.7		5.5	V
I _{OUT}	Maximum constant current of CSy	R _{ISSET} = 10kΩ, GCC=0xFF SL=0xFF		34.5		mA
I _{DD, stop}	Quiescent power supply current	V _{DD} = 5.5V		2.5		mA
Electrical Characteristics (LED Driver)						
I _{LED}	Average current on each LED I _{LED} = I _{OUT(PEAK)} /Duty(4.14)	R _{ISSET} = 10kΩ, GCC=0xFF SL=0xFF		4.22		mA
V _{HR}	Current switch headroom voltage SWx	I _{SWITCH} =612mA R _{ISSET} = 10kΩ, GCC=0xFF, SL=0xFF		450		mV
	Current sink headroom voltage CSy	I _{SINK} =34mA, R _{ISSET} = 10kΩ, GCC=0xFF, SL=0xFF		250		
t _{SCAN}	Period of scanning	(Note 5)		33		μs
t _{NOL1}	Non-overlap blanking time during scan, the SWx and CSy are all off during this time			0.83		μs
t _{NOL2}	Delay total time for CS1 to CS 18, during this time, the SWx is on but CSy is not all turned on	(Note 6)		0.3		μs
Electrical Characteristics (Touch Key)						
ΔC _s	Normal detectable capacitance			40		pF
t _{scan, TK}	Period of scanning for 11 Touch Key channels			55		mS

IS31FL3801

1.3 I2C SWITCHING CHARACTERISTICS

Symbol	Parameter	Condition	Min.	Typ.	Max.	Unit
f _{SCL}	Serial-Clock frequency				400	kHz
t _{BUF}	Bus free time between a STOP and a START condition		1.3			μs
t _{HD, STA}	Hold time (repeated) START condition		0.6			μs
t _{SU, STA}	Repeated START condition setup time		0.6			μs
t _{SU, STO}	STOP condition setup time		0.6			μs
t _{HD, DAT}	Data hold time				0.9	μs
t _{SU, DAT}	Data setup time		100			ns
t _{LOW}	SCL clock low period		1.3			μs
t _{HIGH}	SCL clock high period		0.7			μs
t _R	Rise time of both SDA and SCL signals, receiving	(Note 7)		20+0.1C _b	300	ns
t _F	Fall time of both SDA and SCL signals, receiving	(Note 7)		20+0.1C _b	300	ns
I _{OL}	Low level sink current			10		mA
V _{IH}	Logic "0" input voltage	VDD = 5.5V	1.4			V
V _{IL}	Logic "0" input voltage	VDD = 2.7V			0.4	V

Note 5: The period of SWx is turned on.

Note 6: Guaranteed by design.

Note 7: C_b = total capacitance of one bus line in pF. I_{SINK} ≤ 6mA. t_R and t_F measured between 0.3 × VDD and 0.7 × VDD.

IS31FL3801

1.4 I2C INTERFACE

IS31FL3801 uses a serial bus, which conforms to the I2C protocol, to control the chip's functions with two wires: SCL and SDA. IS31FL3801 has a 7-bit slave address (A7:A1), followed by the R/W bit, A0. Set A0 to "0" for a write command and set A0 to "1" for a read command. The value of bits A1 and A2 are determined by the connection of the AD pin, to GND, 1/3 VDD, 2/3VDD, and VDD.

The complete slave address is:

Bit	A7:A3	A2:A1	A0
Value	01101	AD	1/0

AD connected to GND, AD = 00;

AD connected to 1/3VDD, AD = 01;

AD connected to 2/3VDD = 10;

AD connected to VDD = 11;

AD pin can also be configured as a Touch Key channel. When then AD pin is used for a Touch Key channel, A2: A1 = 00.

The SCL and SDA are open-drain IO so an external pull-up resistor (typically 4.7kΩ) is required. The maximum clock frequency specified by the I2C standard is 400kHz. In this discussion, the master is the host microcontroller and the slave is IS31FL3801.

The timing diagram for the I2C is shown in Figure 2. When there is no interface activity, both the SDA and SCL should be held high.

The "START" signal is generated by lowering the SDA signal while the SCL signal is high. The start signal will alert all devices attached to the I2C bus to check the incoming address against their own chip address.

The 8-bit chip address is sent next, most significant bit first. Each address bit must be stable while the SCL level is high.

After the last bit of the chip address is sent, the master checks for IS31FL3801's acknowledge. The master releases the SDA line which gets pulled to high (through a pull-up resistor). Then the master sends an SCL pulse. If IS31FL3801 has received the address correctly, it holds the SDA line low during the SCL pulse. If the SDA line is not low, the master should send a "STOP" signal (discussed later) and abort the transfer.

Following acknowledge of IS31FL3801, the header byte is sent, most significant bit first. IS31FL3801 must generate another acknowledge indicating that the header has been received.

Following acknowledge of IS31FL3801, the commands or register address byte is sent, most significant bit first. IS31FL3801 must generate another acknowledge indicating that the register address has been received.

Then 8-bit of data byte are sent next, most significant bit first. Each data bit should be valid while the SCL level is stable high. After the data byte is sent, IS31FL3801 must generate another acknowledge to indicate that the data was received.

The "STOP" signal ends the transfer. To signal "STOP", the SDA signal goes high while the SCL signal is high.

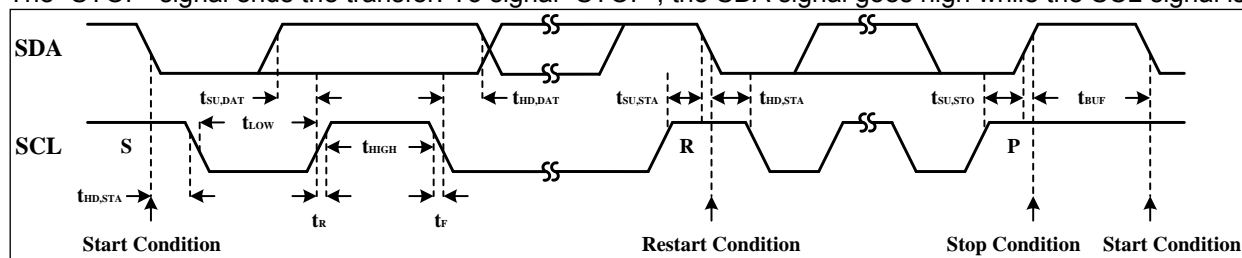

Figure 2 Interface Timing

1.5 READING PORT REGISTERS

To read the device data, the bus master must first send to IS31FL3801's address with the R/\overline{W} bit set to "0", followed by the header byte. The address of the register of interest is then specified. And then the bus master must then send to IS31FL3801's address with the R/\overline{W} bit set to "1". Data from the register defined by the command byte is then sent from IS31FL3801 to the master.

IS31FL3801

1.6 I2C Command Format

In the I2C bus, some devices are masters, and they have to generate the bus clock and initiate communication. To select the IS31FL3801 device, they must choose the right slave address and follow it by a header. If the header is 55h, the commands and data that follows are for the matrix LED driver. If the header is AAh, the commands and data that follows are for the Touch Key controller. If the header is A5h, IS31FL3801 will immediately save the current data in the registers. Saved data will become the default value of IS31FL3801.

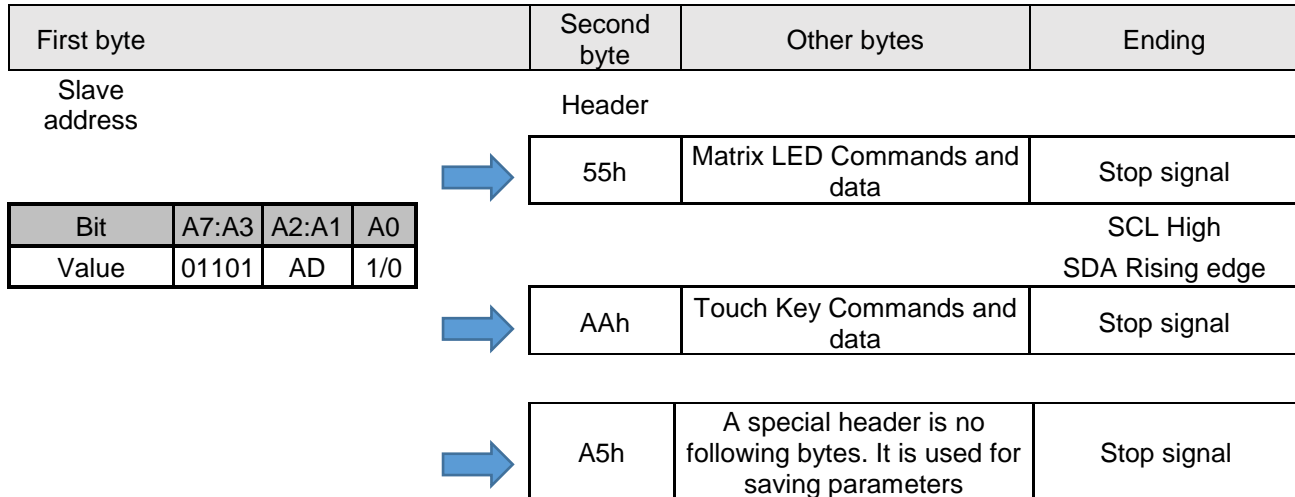

Two examples for the I2C Command are as follows:
The waveforms of Touch Key Commands for Write data.

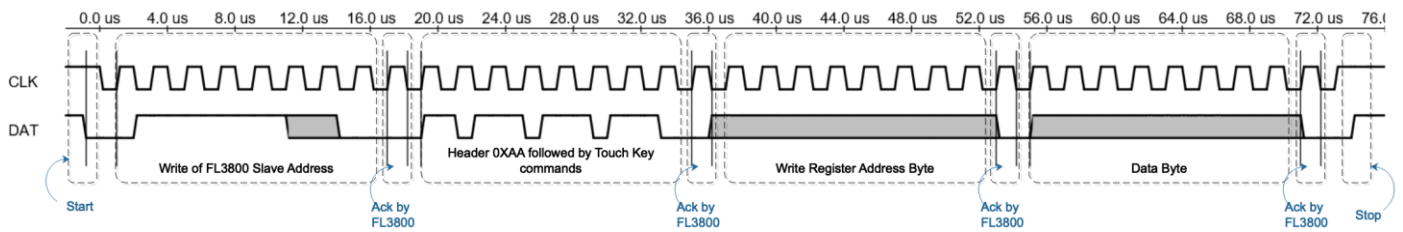

The waveforms of Touch Key Commands for Read data.

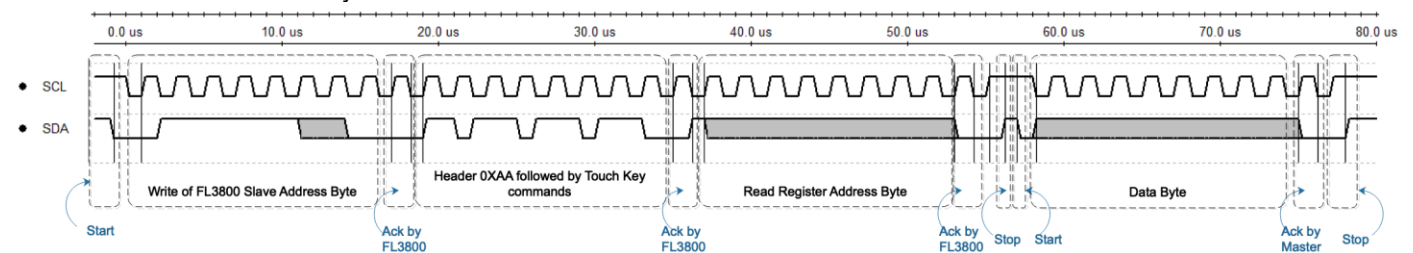

1.7 Matrix LED Operation

Register Definition

Address	Name	Function	Table	R/W	Default
01h~8Fh	PWM Register	Set PWM value for LED	6	W	0000 0000
90h~9Fh	Scaling Register	Control the DC output current of each CSy	7	W	0000 0000
A0h	Configuration Register	Configure the operation mode	8	W	0000 0000
A1h	Global Current Control Register	Set the global current	9	W	0000 0000
B0h	Pull Down/Up Resistor Selection Register	Set the pull down resistor for SWx and pull up resistor for CSy	10	W	0011 0011

IS31FL3801

B1h	Spread Spectrum Register	Spread spectrum function enable	11	W	0000 0000
B2h	PWM Frequency Register	Set the PWM frequency	12	W	0000 0001
B3h~C4h	Open/Short Register	Store the open or short information	13	W	0000 0000
CFh	Reset Register	Reset all register to POR state	-	W	0000 0000

PWM Register

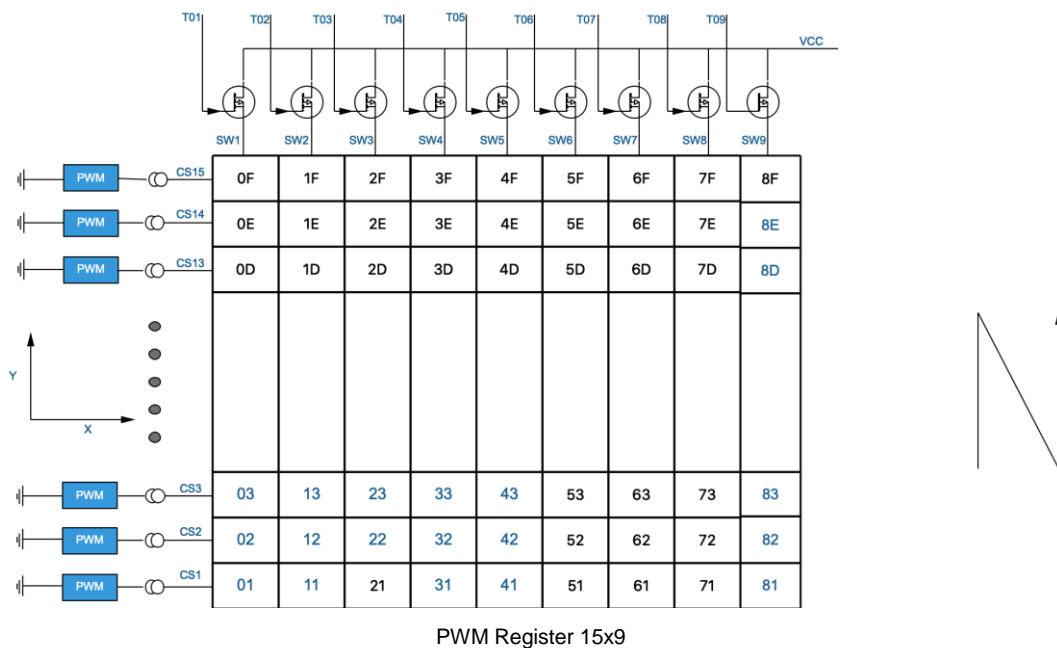
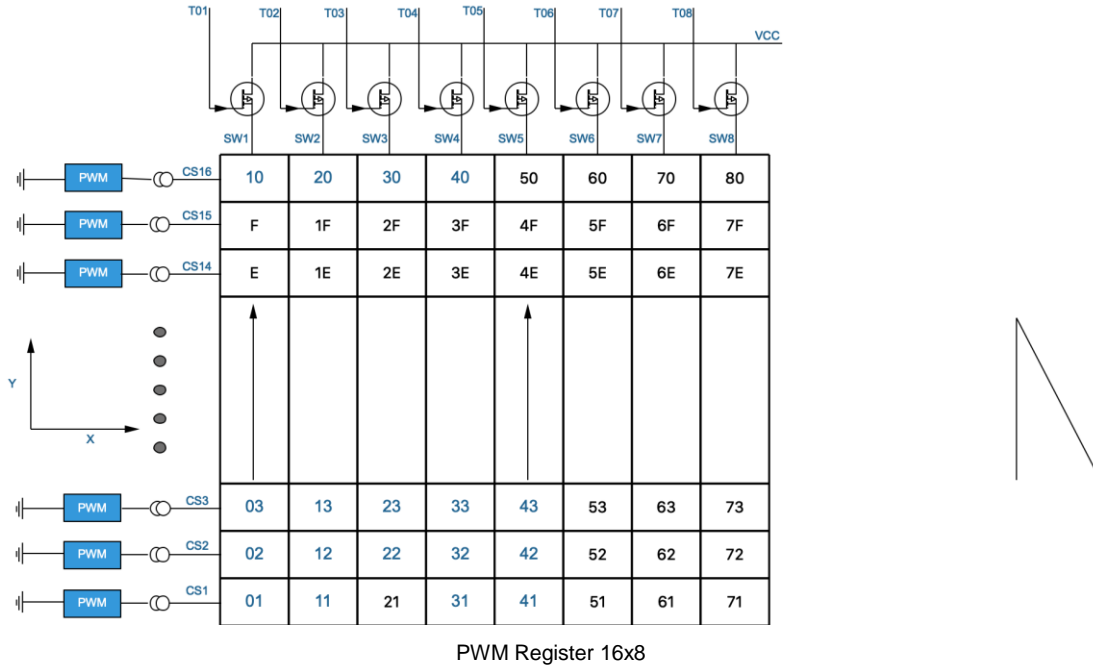

Figure 3 PWM Register

IS31FL3801

01h ~ 8Fh PWM Register

Bit	D7:D0
Name	PWM
Default	0000 0000

Each dot has a byte to modulate the PWM duty in 256 steps.

The value of the PWM Registers decides the average current of each LED noted I_{LED} .

I_{LED} computed by Formula (1):

$$I_{LED} = \frac{PWM}{256} \times I_{OUT(PEAK)} \times Duty \quad (1)$$

Where Duty is the duty cycle of SWx,

$$Duty = \frac{30\mu s}{(30\mu s + 0.8\mu s + 0.27\mu s)} \times \frac{1}{9} = \frac{1}{9.32} \quad (2)$$

I_{OUT} is the output current of CSy (y=1~16),

$$I_{OUT(PEAK)} = \frac{342}{R_{ISET}} \times \frac{GCC}{64} \times \frac{SL}{256} \quad (3)$$

GCC is the Global Current Control Register (A1h) value, SL is the Scaling Register value as below and R_{ISET} is the external resistor of ISET pin. D[n] stands for the individual bit value, 1 or 0, in location n.

For example: if D7:D0=1011 0101 (0xB5, 181), GCC= 100 0000, R_{ISET} =10k Ω , SL=1111 1111:

$$I_{LED} = \frac{342}{10k\Omega} \times \frac{64}{64} \times \frac{255}{256} \times \frac{1}{9.32} \times \frac{181}{256}$$

Scaling Register

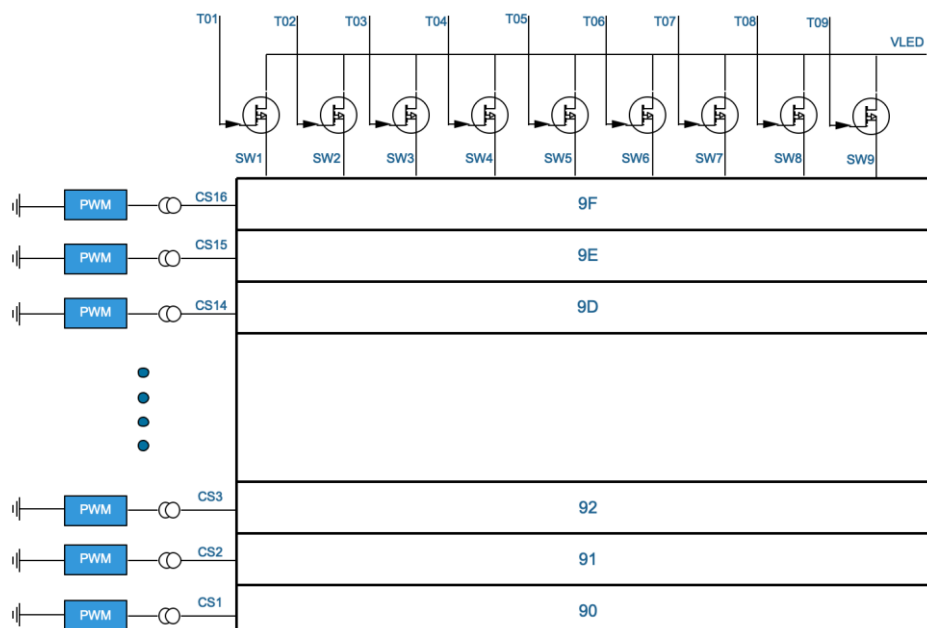

Figure 4 Scaling Register

IS31FL3801

90h ~ 9Fh Scaling Register

Bit	D7:D0
Name	SL
Default	0000 0000

Scaling register control the DC output current of each dot. Each dot has a byte to modulate the scaling in 256 steps. The value of the Scaling Register decides the peak current of each LED noted $I_{OUT(PEAK)}$. $I_{OUT(PEAK)}$ computed by Formula (3).

A0h Configuration Register

Bit	D7:D4	D3	D2:D1	D0
Name	SWS	LGC	OSDE	SSD
Default	0001	0	00	0

The Configuration Register sets operating mode of IS31FL3801.

SSD Software Shutdown Control
 0 Software shutdown
 1 Normal operation

OSDE Open Short Detection Enable
 00 Disable open/short detection
 01/11 Enable open detection
 10 Enable short detection

LGC H/L logic
 0 1.4V/0.4V
 1 2.4V/0.6V

SWS SWx Setting
 0000 n=9, SW1~SW9, 9SWx15CS matrix
 0001 n=8, SW1~SW8, 8SWx16CS matrix
 0010 n=7, SW1~SW7, 7SWx16CS matrix, SW8 no-active
 0011 n=6, SW1~SW6, 6SWx16CS matrix, SW7~SW8 no-active
 0100 n=5, SW1~SW5, 5SWx16CS matrix, SW6~SW8 no-active
 0101 n=4, SW1~SW4, 4SWx16CS matrix, SW5~SW8 no-active
 0110 n=3, SW1~SW3, 3SWx16CS matrix, SW4~SW8 no-active
 0111 n=2, SW1~SW2, 2SWx16CS matrix, SW3~SW8 no-active
 1000 SW1~SW9 with same phase, all on.
 Others SW1~SW9, SW1~SW9, 9SWx15CS matrix

When OSDE set to "01", open detection will be trigger once, the user could trigger open detection again by set OSDE from "00" to "01".

When OSDE set "10", short detection will be trigger once, the user could trigger short detection again by set OSDE from "00" to "10".

When SSD is "0", IS31FL3801 works in software shutdown mode and to normal operate the SSD bit should set to "1". SWS control the duty cycle of the SWx, default mode is 1/8.

IS31FL3801

A1h Global Current Control Register

Bit	D7	D6:D0
Name	-	GCC
Default	0	000 0000

The Global Current Control Register modulates all CSy (y=1~16) DC current which is noted as I_{OUT} in 65 steps, maximum GCC is "100 0000", if GCC> "1000000", GCC= "100 0000".

I_{OUT} is computed by the Formula (3):

$$I_{OUT(PEAK)} = \frac{342}{R_{ISET}} \times \frac{GCC}{64} \times \frac{SL}{256}$$

$$GCC = \sum_{n=0}^7 D[n] \cdot 2^n$$

Where D[n] stands for the individual bit value, 1 or 0, in location n.

B0h Pull Down/Up Resistor Selection Register

Bit	D7	D6:D4	D3	D2:D0
Name	PHC	SWPDR	-	CSPUR
Default	0	011	0	011

Set pull down resistor for SWx and pull up resistor for CSy.

PHC Phase choice
 0 0 degree phase delay
 1 180 degree phase delay

SWPDR SWx Pull down Resistor Selection Bit
 000 No pull down resistor
 001 0.5kΩ only in SWx off time
 010 1.0kΩ only in SWx off time
 011 2.0kΩ only in SWx off time
 100 1.0kΩ all the time
 101 2.0kΩ all the time
 110 4.0kΩ all the time
 111 8.0kΩ all the time

CSPUR CSy Pull up Resistor Selection Bit
 000 No pull up resistor
 001 0.5kΩ only in CSx off time
 010 1.0kΩ only in CSx off time
 011 2.0kΩ only in CSx off time
 100 1.0kΩ all the time
 101 2.0kΩ all the time
 110 4.0kΩ all the time
 111 8.0kΩ all the time

IS31FL3801

B1h Spread Spectrum Register

Bit	D7:D6	D4	D3:D2	D1:D0
Name	-	SSP	RNG	CLT
Default	00	0	00	00

When SSP enable, the spread spectrum function will be enabled and the RNG & CLT bits will adjust the range and cycle time of spread spectrum function.

SSP Spread spectrum function enable
 0 Disable
 1 Enable

RNG Spread spectrum range
 00 ±5%
 01 ±15%
 10 ±24%
 11 ±34%

CLT Spread spectrum cycle time
 00 1980µs
 01 1200µs
 10 820µs
 11 660µs

B2h PWM Frequency

Bit	D7:D3	D2:D0
Name	-	PWMF
Default	00000	001

Set the PWM frequency, default is 32 kHz. In order to avoid LED display flicker, it is recommended PWM frequency ÷ n is higher than 100Hz, so when PWM frequency is 0.5 kHz, n cannot be more than 4, when PWM frequency is 0.25 kHz, n cannot be more than 2.

PWMF PWM frequency setting
 000 55kHz
 001 32kHz
 010 4kHz
 011 2kHz
 100 1kHz
 101 0.5kHz, (n≤4)
 110 0.25KHz, (n≤2)
 111 80kHz

IS31FL3801

B3h~C4h Open/Short Register (Read Only)

Bit	D7:D0
Name	CS16:CS09, CS08:CS01
Default	0000 0000

When OSDE (A0h) is set to “01”, open detection will be trigger once, and the open information will be stored at B3h~C4h.

When OSDE (A0h) set to “10”, short detection will be trigger once, and the short information will be stored at B3h~C4h.

Before set OSDE, the GCC should set to 0x01.

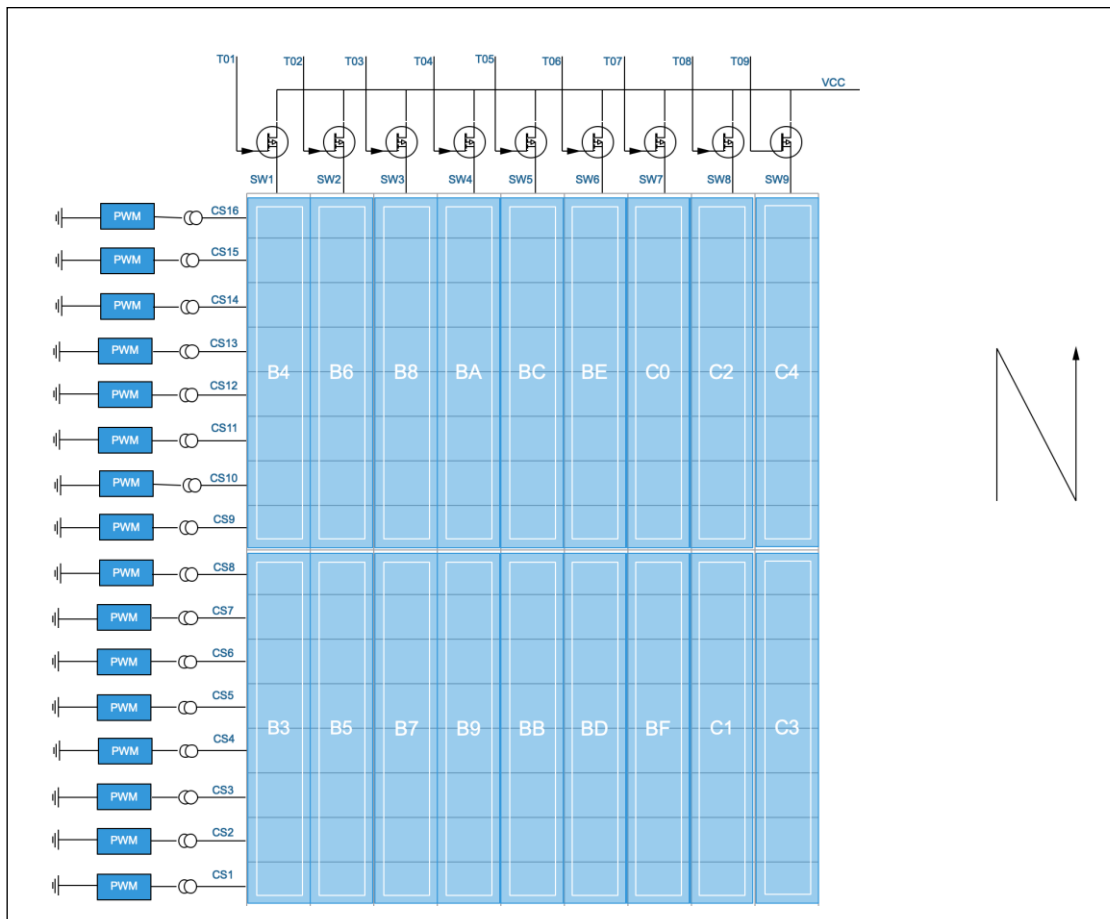

Figure 5 Open/Short Register

CFh Reset Register

Once user writes the Reset Register with 0xAE, IS31FL3801 will reset all the IS31FL3801 registers to their default value. On initial power-up, the IS31FL3801 registers are reset to their default values for a blank display.

IS31FL3801

APPLICATION INFORMATION

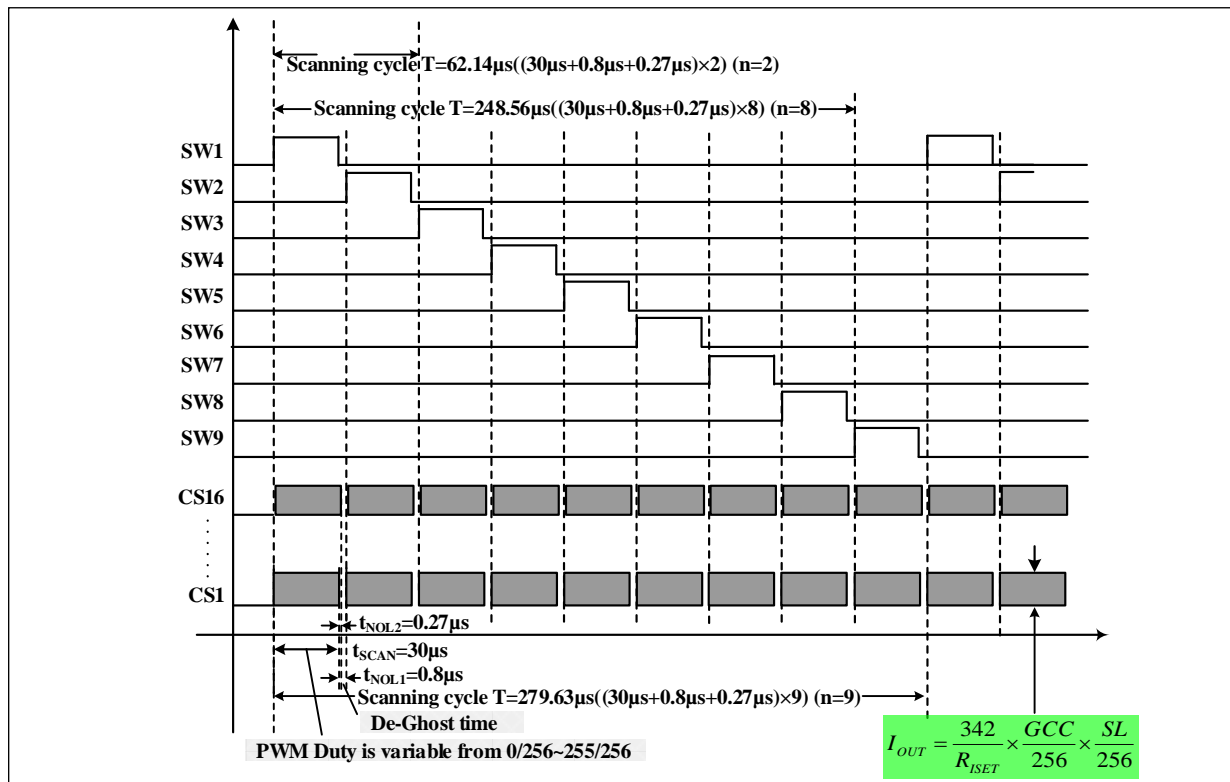

SCANNING TIMING

As shown in Figure above, the SW1~SW9 is turned on by serial, LED is driven 15 by 9 within the SWx (x=1~9) on time (SWx, x=1~9 is source and it is high when LED on), including the non-overlap blanking time during scan, the duty cycle of SWx (active high, x=1~9) is (n=9):

$$Duty = \frac{30\mu s}{(30\mu s + 0.8\mu s + 0.27\mu s)} \times \frac{1}{9} = \frac{1}{9.32} \quad \text{used the formula (2)}$$

Or (n=8):

$$Duty = \frac{30\mu s}{(30\mu s + 0.8\mu s + 0.27\mu s)} \times \frac{1}{8} = \frac{1}{8.29} \quad \text{used the formula (2)}$$

Where $30\mu s$ is t_{SCAN} , the period of scanning and $0.8\mu s$ is t_{NOL1} , the non-overlap time and $0.27\mu s$ is the CSx delay time.

PWM CONTROL

After setting the I_{OUT} and GCC, the brightness of each LEDs (LED average current (I_{LED})) can be modulated with 256 steps by PWM Register, as described in Formula (1).

$$I_{LED} = \frac{PWM}{256} \times I_{OUT(PEAK)} \times Duty \quad (1)$$

Where PWM is PWM Registers' (01h~8Fh) data showing in PWM registers.

For example, in Figure 1, if $R_{ISET} = 10k\Omega$, PWM= 1011 0101 (0xB5, 181), and GCC= 100 0000, SL= 1111 1111, then,

$$I_{OUT(PEAK)} = \frac{342}{R_{ISET}} \times \frac{GCC}{64} \times \frac{SL}{256} \quad I_{LED} = \frac{342}{10k\Omega} \times \frac{64}{64} \times \frac{255}{256} \times \frac{1}{9.32} \times \frac{181}{256} \quad (n=9)$$

Writing new data continuously to the registers can modulate the brightness of the LEDs to achieve a breathing effect.

IS31FL3801

GAMMA CORRECTION

In order to perform a better visual LED breathing effect we recommend using a gamma corrected PWM value to set the LED intensity. This results in a reduced number of steps for the LED intensity setting, but causes the change in intensity to appear more linear to the human eye.

Gamma correction, also known as gamma compression or encoding, is used to encode linear luminance to match the non-linear characteristics of display. Since the IS31FL3801 can modulate the brightness of the LEDs with 256 steps, a gamma correction function can be applied when computing each subsequent LED intensity setting such that the changes in brightness matches the human eye's brightness curve.

32 Gamma Steps with 256 PWM Steps

C(0)	C(1)	C(2)	C(3)	C(4)	C(5)	C(6)	C(7)
0	1	2	4	6	10	13	18
C(8)	C(9)	C(10)	C(11)	C(12)	C(13)	C(14)	C(15)
22	28	33	39	46	53	61	69
C(16)	C(17)	C(18)	C(19)	C(20)	C(21)	C(22)	C(23)
78	86	96	106	116	126	138	149
C(24)	C(25)	C(26)	C(27)	C(28)	C(29)	C(30)	C(31)
161	173	186	199	212	226	240	255

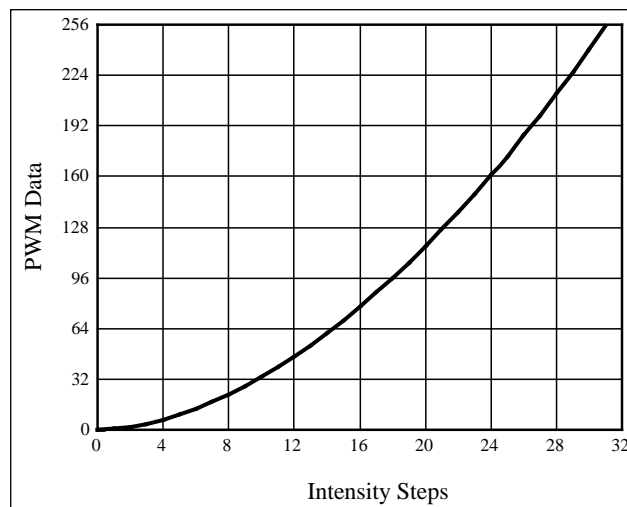

Figure 6 Gamma Correction (32 Steps)

Choosing more gamma steps provides for a more continuous looking breathing effect. This is useful for very long breathing cycles. The recommended configuration is defined by the breath cycle T. When T=1s, choose 32 gamma steps, when T=2s, choose 64 gamma steps. The user must decide the final number of gamma steps not only by the LED itself, but also based on the visual performance of the finished product.

64 Gamma Steps with 256 PWM Steps

C(0)	C(1)	C(2)	C(3)	C(4)	C(5)	C(6)	C(7)
0	1	2	3	4	5	6	7
C(8)	C(9)	C(10)	C(11)	C(12)	C(13)	C(14)	C(15)
8	10	12	14	16	18	20	22
C(16)	C(17)	C(18)	C(19)	C(20)	C(21)	C(22)	C(23)
24	26	29	32	35	38	41	44
C(24)	C(25)	C(26)	C(27)	C(28)	C(29)	C(30)	C(31)
47	50	53	57	61	65	69	73
C(32)	C(33)	C(34)	C(35)	C(36)	C(37)	C(38)	C(39)
77	81	85	89	94	99	104	109

IS31FL3801

C(40)	C(41)	C(42)	C(43)	C(44)	C(45)	C(46)	C(47)
114	119	124	129	134	140	146	152
C(48)	C(49)	C(50)	C(51)	C(52)	C(53)	C(54)	C(55)
158	164	170	176	182	188	195	202
C(56)	C(57)	C(58)	C(59)	C(60)	C(61)	C(62)	C(63)
209	216	223	230	237	244	251	255

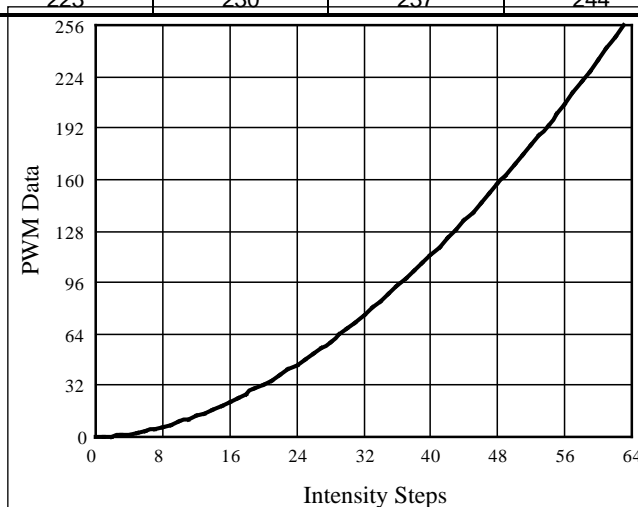

Figure 7 Gamma Correction (64 Steps)

Note: The data of 32 gamma steps is the standard value and the data of 64 gamma steps is the recommended value.

OPERATING MODE

IS31FL3801 can only operate in PWM Mode. The brightness of each LED can be modulated with 256 steps by PWM registers. For example, if the data in PWM Register is “0000 0100”, then the PWM is the fourth step.

Writing new data continuously to the registers can modulate the brightness of the LEDs to achieve a breathing effect.

OPEN/SHORT DETECT FUNCTION

IS31FL3801 has open and short detect bit for each LED.

By setting the OSDE bits of the Configuration Register (A0h) from “00” to “01” or “10”, the LED Open/short Register will start to store the open/short information and after at least 2 scanning cycles and the MCU can get the open/short information by reading the B3h~C4h, the open/short data will not get refreshed when setting the OSDE bit of the Configuration Register.

The two configurations need to set before setting the OSDE bits:

- 1 . 0x0F≤GCC≤0x40, B0h=0x00
- 2 . 0x01≤GCC≤0x40, B0h=0x30

Where GCC is the Global Current Control Register (A1h) and both case 1 or two can get the correct open and short information. B0h is the Pull Down/UP Resistor Selection Register and 0x30 is to enable the SWx pull-up function.

The detect action is one-off event and each time before reading out the open/short information, the OSDE bit of the Configuration Register (A0h) need to be set from “0” to “1” (clear before set operation).

DE-GHOST FUNCTION

The “ghost” term is used to describe the behavior of an LED that should be OFF but instead glows dimly when another LED is turned ON. A ghosting effect typically can occur when multiplexing LEDs. In matrix architecture any parasitic capacitance found in the constant-current outputs or the PCB traces to the LEDs may provide sufficient current to dimly light an LED to create a ghosting effect.

IS31FL3801

To prevent this LED ghost effect, the IS31FL3801 has integrated Pull down resistors for each SWx (x=1~9) and Pull up resistors for each CSy (y=1~16). Select the right SWx Pull down resistor (B0h) and CSy Pull up resistor (B0h) which eliminates the ghost LED for a particular matrix layout configuration.

Typically, selecting the 2k Ω will be sufficient to eliminate the LED ghost phenomenon.

The SWx Pull down resistors and CSy Pull up resistors are active only when the CSy/SWx output working the OFF state and therefore no power is lost through these resistors.

SHUTDOWN MODE

Shutdown mode can be used as a means of reducing power consumption. During shutdown mode all registers retain their data.

Software Shutdown

By setting SSD bit of the Configuration Register (A0h) to "0", the IS31FL3801 will operate in software shutdown mode. When the IS31FL3801 is in software shutdown, all current sources are switched off, so that the matrix is blanked. All registers can be operated. Typical current consume is 3 μ A.

Hardware Shutdown

The chip enters hardware shutdown when the SDB pin is pulled low. All analog circuits are disabled during hardware shutdown, typical the current consume is 3 μ A.

The chip releases hardware shutdown when the SDB pin is pulled high. During hardware shutdown state Function Register can be operated.

If V_{CC} has risk drop below 1.75V but above 0.1V during SDB pulled low, please re-initialize all Function Registers before SDB pulled high.

LAYOUT

As described in external resistor (R_{ISSET}), the chip consumes lots of power. Please consider below factors when layout the PCB.

1. The V_{CC} capacitors need to close to the chip and the ground side should well connected to the GND of the chip.
2. R_{ISSET} should be close to the chip and the ground side should well connect to the GND of the chip.
3. The thermal pad should connect to ground pins and the PCB should have the thermal pad too, usually this pad should have 9 or 16 via thru the PCB to other side's ground area to help radiate the heat. About the thermal pad size, please refer to the land pattern of each package.
4. The CSy pins maximum current is 35mA (R_{ISSET}=10k Ω), and the SWx pins maximum current is larger, the width of the trace, SWx should have wider trace than CSy.

IS31FL3801

1.8 Touch Key Operation

Register Function

Address	Name	Function	R/W	Default	
00h	Main Control Register	Controls general power states and power dissipation	R/W	0000 0000	
01h	INT Configuration Register	Interrupt configuration		0000 1000	
02h	Key Status Register 1	Key0~Key7 status bits	R	0000	
03h	Key Status Register 2	Key8~Key10 status bits		0000	
04h	Interrupt Enable Register 1	Key0~key7 Enables Interrupts associated with capacitive touch sensor inputs	R/W	1111 1111	
05h	Interrupt Enable Register 2	Key8~key10 Enables Interrupts associated with capacitive touch sensor inputs		0000 0111	
06h	Key Enable Register 1	Key0~key7 sets the channels enable		1111 1111	
07h	Key Enable Register 2	Key8~key10 sets the channels enable		0000 0111	
08h	Multiple Touch Key Configure Register	Multiple touch key function setting		0000 0000	
09h	Auto-Clean Interrupt Register	Set auto-clean interrupt time and enable		0000 1111	
0Ah	Interrupt Repeat Time Register	Set repeat cycle for pressing key interrupt		0011 1111	
0Bh	Auto-SLEEP Mode Register	Set auto enter SLEEP Mode time		0000	
0Ch	Exit SLEEP Mode Register 1	Set press Key0~Key7 to exit SLEEP Mode		0000	
0Dh	Exit SLEEP Mode Register 2	Set press Key8~Key10 to exit SLEEP Mode		0010 1100	
0Eh	Gain and Press Time Setting Register	Set gain and pressing trigger time		0010 0100	
0Fh	Key Touch Sampling Configure Register	Set sampling times and cycle time		0011 0000	
10h	Calibration Configure Register	Set auto-calibration cycle and negative value trigger setting		0000	
11h	Force Calibration Register 1	Key0~Key7 calibration enable forcibly		0000	
12h	Force Calibration Register 2	Key8~Key10 calibration enable forcibly		0011 0010	
13h	Noise Threshold Register	Set noise threshold value		0000 0000	
14h	Noise Indication Register 1	Key0~Key7 noise indication		R	0000
15h	Noise Indication Register 2	Key8~key10 noise indication			0000
17h	Negative Threshold Register	Set negative threshold and compel calibration threshold		R/W	0000 1001
18h	Wake Up Threshold Register	Set wake up threshold			0000 0101
19h	Scan Voltage Register	Set scanning voltage	0111 0000		
1Ah	Scan Frequency Register 1	Set the first and second scanning frequencies	0111 0011		
1Bh	Scan Frequency Register 2	Set the third and fourth scanning frequencies	1011 1000		
20h~2Ah	KEY0~KEY10 Variation Value Register	Keys value setting	R	0000 0000	
30h~3Ah	KEY0~KEY10 Threshold Set Register	Keys threshold setting	R/W	0011 0000	

IS31FL3801

40h,42h ... 52h,54h	KEY0~KEY10 Calibration Low Bit Register	Internal calibration low 8-bit for KEY0~KEY10	R	0000 0000
41h,43h ... 53h,55h	KEY0~KEY10 Calibration High Bit Register	Internal calibration high 8-bit for KEY0~KEY10		
60h	GPIO Enable Register 1	Key0~key7 sets the GPIO enable	R/W	0000 0000 1110 0000 0000 0111
61h	GPIO Enable Register 2	Key8~key10 sets the GPIO enable		
62h	GPIO Value Register 1	Key0~key7 set the GPIO values		
63h	GPIO Value Register 2	Key8~key10 set the GPIO values		
64h	Slider Enable Register 1	Key0~key7 sets the slider enable		
65h	Slider Enable Register 2	Key8~key10 sets the slider enable		
66h	Slider Status Register1	Slider status reply1	R	0000 0000
67h	Slider Status Register2	Slider status reply2		
68h	Slider Status Register3	Slider status reply3	R/W	1000 0000 0101 0110 0111 1000 1001 1010
69h	Key position 1-2 of Slider1	Shows the position of Slider1		
6Ah	Key position 3-4 of Slider1	Shows the position of Slider1		
6Bh	Key position 5-6 of Slider1	Shows the position of Slider1		
6Fh	Version Control Register	Shows the firmware version	R	0100 0000
70h~75h	Slider Calibration Register 1-6	Slider calibration from the first Key to the sixth Key	R/W	0001 0101 0000 0000
76h	Spread Spectrum Configuration	Spread spectrum setting		

00h Main Control Register (Write Only)

Bit	D7	D6	D5	D4	D3	D2:D0
Name	SR	-	SDM	SP	-	-
Default	0	0	0	0	0	000

SR	System Reset
0	Normal Mode
1	System Reset
SDM	Shutdown Mode
0	Normal Mode
1	Shutdown Mode
SP	Sleep Mode
0	Normal Mode
1	SLEEP Mode

00h Main Control Register (Read Only)

Bit	D7:D0
Name	PID
Default	0X31

PID	Product ID, It is read only. User cannot modify the value.
Default	0X31

IS31FL3801

01h Interrupt Configuration Register

Bit	D7:D4	D3	D2	D1	D0
Name	-	MDEND	INM	INE	-
Default	0000	1	0	0	0

MDEN Maximum Duration Time Enable
 0 Disable
 1 Enable

Maximum press function is used to prevent key pressing all the time by accident. When maximum press function is enabled, once key keep pressing at programmed time the key calibration value will be updated.

INM Interrupt Mode
 0 Interrupt Mode 0(Touch key trigger once interrupt)
 1 Interrupt Mode 1(Touch key trigger repeated interrupt)

INM bit sets interrupt time for once or multiple. Multiple interrupt is used for key pressing detection.

INE Interrupt Function Enable
 0 Disable
 1 Enable

02h Key Status Register 1 (Read only)

Bit	D7:D0
Name	KS[7:0]
Default	0000 0000

03h Key Status Register 2 (Read only)

Bit	D7:D3	D2:D0
Name	-	KS[10:8]
Default	0000 0	000

KS[10:0] Key0~Key10 Status
 0 No action
 1 Press or release keys

If the value of KSx is detected over programmed threshold, the corresponding bit will be set to “1”.

04h Interrupt Enable Register 1

Bit	D7:D0
Name	KINT[7:0]
Default	1111 1111

05h Interrupt Enable Register 2

Bit	D7:D3	D2:D0
Name	-	KINT[10:8]
Default	0000 0	111

The Interrupt Enable Register determines whether a sensor pad touch or release (if enabled) causes the interrupt pin to be asserted.

KINT[10:0] Key Interrupt Enable
 0 Disable
 1 Enable

The default value for Interrupt Enable Registers is interrupt enable. Only set INE bit of Interrupt Configuration Register (01h) to “0”, INTB pin will generate interrupt signal.

IS31FL3801

06h Key Enable Register 1

Bit	D7:D0
Name	KEN[7:0]
Default	1111 1111

07h Key Enable Register 2

Bit	D7:D3	D2:D0
Name	-	KEN[10:8]
Default	0000 0	111

KEN[10:0] Touch Key Enable Setting
0 Disable
1 Enable

08h Multiple Touch Key Configure Register

Bit	D7:D3	D2	D1:D0
Name	-	MKEN	MTK[1:0]
Default	0000 0	0	00

MKEN Multi- Key Enable
0 Disable
1 Enable

MTK[1:0] Multi -Key Selection
01 Allow one key triggered at same time
10 Allow two keys triggered at same time
11 Allow three keys triggered at same time

09h Auto-Clear Interrupt Register

Bit	D7:D4	D3	D2:D0
Name	-	ACEN	ACT[2:0]
Default	0000	0	000

ACEN Auto-Clear Interrupt Enable
0 Disable
1 Enable

ACT[2:0] Auto-Clear Interrupt Time
000 10ms
001 20ms
010 30ms
011 40ms
100 50ms
101 100ms
110 150ms
111 200ms

When ACEN=0, the INTB will keep low until MCU read 02h and 03h registers. When ACEN=1, if MCU don't read 02h and 03h registers within programmed time (ACT=10ms~200ms), INTB pin will be release automatically.

IS31FL3801

0Ah Interrupt Repeat Time Register

Bit	D7:D4	D3:D0
Name	INTRT[3:0]	MPT[3:0]
Default	0000	1111

INTRT[3:0]	Interrupt Repeat Time
0000	Close
0001	50ms
0010	100ms
0011	150ms
0100	200ms
0101	250ms
0110	300ms
0111	350ms
1000	400ms
1001	450ms
1010	500ms
1011	600ms
1100	700ms
1101	800ms
1110	900ms
1111	1s

MPT[3:0]	Multi-key Press Time
0000	Close
0001	50ms
0010	100ms
0011	150ms
0100	200ms
0101	250ms
0110	300ms
0111	350ms
1000	400ms
1001	450ms
1010	500ms
1011	600ms
1100	700ms
1101	800ms
1110	900ms
1111	1s

When set the INM as 1 and several keys are pressed, it will generate the second interrupt until M_PRESS_TIME after the first interrupt. Then wait for INT_RPT_TIME to trigger the third interrupt. After all of these if the keys are still pressing, wait for INT_RPT_TIME to trigger others interrupt until keys release.

0Bh Auto-SLEEP Set Register

Bit	D7	D6:D4	D3:D0
Name	ASEN	OSCD[2:0]	AST[3:0]
Default	0	011	1111

ASEN	Auto-SLEEP Enable
0	Disable
1	Enable

OSCD[2:0]	Auto-Sleep Oscillator Division
000	1

IS31FL3801

001	2
010	4
011	8
100	16
101	32
110	64
111	128

AST[3:0]	Auto-SLEEP Time
0000	0.5s
0001	1s
0010	1.5s
0011	2s
0100	2.5s
0101	3s
0110	3.5s
0111	4s
1000	5s
1001	6s
1010	7s
1011	8s
1100	9s
1101	10s
1110	11s
1111	12s

When ASEN=1 and no actions on touch key and I2C interface, the IC will enter into SLEEP Mode after programmed time (AST).

0Ch Exit SLEEP Mode Register 1

Bit	D7:D1
Name	ESMEN[7:0]
Default	0000 0000

0Dh Exit SLEEP Mode Register 2

Bit	D7:D3	D2:D0
Name	-	ESMEN[10:8]
Default	0000 0	000

ESMEN[10:0]	Exit Sleep Mode Enable
0	Touch key can't trigger exiting SLEEP Mode
1	Touch key trigger exiting SLEEP Mode

When IC is in Normal Mode and ASEN=1, set ESMENx=1 will exit from SLEEP Mode by pressing the corresponding key.

0Eh Gain and Press Time Setting Register

Bit	D7:D4	D3:D0
Name	GAIN[3:0]	MDT[3:0]
Default	0010	1100

GAIN[3:0]	Gain Control
0000	1X
0001	2X
0010	3X
0011	4X

IS31FL3801

0100	5X
0101	6X
0110	7X
0111	8X
1000	9X
1001	10X
1010	11X
1011	12X
1100	13X
1101	14X
1110	15X
1111	16X

The GAIN bits are used to set the gain factor. Internal count will count the final value and put it into KEY_x_ΔCOUNT.

MDT[3:0]	Max Duration Time
0000	0.5s
0001	1s
0010	2s
0011	3s
0100	4s
0101	5s
0110	6s
0111	7s
1000	8s
1001	9s
1010	10s
1011	11s
1100	12s
1101	13s
1110	14s
1111	15s

MPT bits set the pressing time. When key pressed continue over the programmed time (MDT), system will force to calibrate the pressed key. Set MDEN to “1” will enable this function.

0Fh Key Touch Sampling Configure Register

Bit	D7:D4	D3:D2	D1:D0
Name	SC[3:0]	ST[1:0]	CDS[1:0]
Default	0010	01	00

SC[3:0]	Touch Key Sampling Count Setting
0000	1
0001	2
0010	3
0011	4
0100	5
0101	6
0110	7
0111	8
1000	9
1001	10
1010	11
1011	12
1100	13
1101	14
1110	15
1111	16

IS31FL3801

SC is used to set average sampling times for each channel. Higher SC value will increase stability and anti-interference ability, but decrease reaction speed.

ST[1:0]	Sampling Time (Single Channel)
00	1
01	2
10	4
11	8

CDS[1:0]	Cycle Delay Time
00	0ms
01	10ms
10	20ms
11	30ms

Sampling 16 channels is for one cycle.

10h Calibration Configure Register

Bit	D7	D6:D4	D3:D2	D1:D0
Name	-	CSC[2:0]	-	NDC[1:0]
Default	0	011	00	00

CSC[2:0]	Calibrate Sample Count
000	2
001	4
010	8
011	16
100	32
101	64
110	128
111	256

If there is no action on keys, environmental capacitance will be calibrated after CSC times.

NDC[1:0]	Negative Delta Count
00	4
01	8
10	16
11	32

If channel detects the value over negative threshold (NDTH) for NDC times, it will be calibrated forcibly.

11h Force Calibration Register 1

Bit	D7:D0
Name	FCK[7:0]
Default	0000 0000

12h Force Calibration Register 2

Bit	D7:D3	D2:D0
Name	-	FCK[10:8]
Default	0000 0	000

FCK[10:0]	Individual Force Calibrate Key
0	Close
1	Enable

When enable FCKx, the corresponding bit will be set to "0".

IS31FL3801

13h Noise Threshold Register

Bit	D7:D0
Name	NTH
Default	0011 0010

The noise threshold is from 0~127. It is invalid if NTH>127.

If difference value between samplings is over the programmed threshold, the corresponding noise bit will be set to “1”.

14h Noise Indication Register 1 (Read Only)

Bit	D7:D0
Name	NK[7:0]
Default	0000 0000

15h Noise Indication Register 2 (Read Only)

Bit	D7:D3	D2:D0
Name	-	NK[10:8]
Default	0000 0	000

NK[10:0] Noise Indication
 0 No noise
 1 Noise

17h Negative Threshold Register

Bit	D7:D4	D3:D0
Name	NCTH[3:0]	NDTH[3:0]
Default	0000	1001

NCTH[3:0] Negative Calibrate Threshold Setting
 0000 Disabled
 0001 -10
 0010 -20
 0011 -30
 0100 -40
 0101 -50
 0110 -60
 0111 -70
 1000 -80
 1001 -90
 1010 -100
 1011 -110
 1100 -120
 1101 Not available
 1110 Not available
 1111 Not available

NDTH[3:0] Negative Delta Threshold Setting
 0000 -1
 0001 -2
 0010 -3
 0011 -4
 0100 -5
 0101 -6
 0110 -7

IS31FL3801

0111	-8
1000	-9
1001	-10
1010	-11
1011	-12
1100	-13
1101	-14
1110	-15
1111	-16

When negative value is over the programmed threshold (NCTH), the channel will be calibrated forcibly.
 If negative value is detected over threshold for NDTH times continually, the channel will be calibrated forcibly.

18h Wake Up Threshold Register

Bit	D7	D6:D0
Name	-	WTH[6:0]
Default	0	000 0101

Wake up threshold, the range is 0 – 127

19h Scan Voltage Register

Bit	D7	D6:D4	D3	D2:D0
Name	VTH	ZERO_Time [2:0]	REFSEL	-
Default	0	111	0	000

VTH Scan Voltage
 If REFSEL = 0
 0 C_{REF} charges to 0.9V
 1 C_{REF} charges to 1.35V
 If REFSEL = 1
 0 C_{REF} charges to VDDH/2
 1 C_{REF} charges to VDDH*3/4

ZERO_Time [2:0] Discharge time of C_{REF}
 000 8 us
 001 16 us
 010 24 us
 011 32 us
 100 40 us
 101 48 us
 110 56 us
 111 64 us

REFSEL C_{REF} charges source selection
 0 The C_{REF} charging source is 1.8V
 1 The C_{REF} charging source is VDDH

1Ah Scan Frequency Register 1

Bit	D7:D4	D3:D0
Name	SSF[3:0]	FSF[3:0]
Default	0111	0011

FSF[3:0] First scan frequency
 0000 8 MHZ
 0001 4 MHZ

IS31FL3801

0010	2.67 MHZ
0011	2 MHZ
0100	1.6 MHZ
0101	1.33 MHZ
0110	1.14 MHZ
0111	1 MHZ
1000	0.89 MHZ
1001	0.8 MHZ
1010	0.73 MHZ
1011	0.67 MHZ
1100	0.62 MHZ
1101	0.57 MHZ
1110	0.53 MHZ
1111	0.5M HZ
SSF[3:0]	Second scan frequency
0000	8 MHZ
0001	4 MHZ
0010	2.67 MHZ
0011	2 MHZ
0100	1.6 MHZ
0101	1.33 MHZ
0110	1.14 MHZ
0111	1 MHZ
1000	0.89 MHZ
1001	0.8 MHZ
1010	0.73 MHZ
1011	0.67 MHZ
1100	0.62 MHZ
1101	0.57 MHZ
1110	0.53 MHZ
1111	0.5M HZ

1Bh Scan Frequency Register 2

Bit	D7:D4	D3:D0
Name	OSF[3:0]	TSF[3:0]
Default	1011	1000

TSF[3:0]	Third scan frequency
0000	8 MHZ
0001	4 MHZ
0010	2.67 MHZ
0011	2 MHZ
0100	1.6 MHZ
0101	1.33 MHZ
0110	1.14 MHZ
0111	1 MHZ
1000	0.89 MHZ
1001	0.8 MHZ
1010	0.73 MHZ
1011	0.67 MHZ
1100	0.62 MHZ
1101	0.57 MHZ
1110	0.53 MHZ
1111	0.5M HZ

IS31FL3801

OSF[3:0]	Fourth scan frequency
0000	8 MHZ
0001	4 MHZ
0010	2.67 MHZ
0011	2 MHZ
0100	1.6 MHZ
0101	1.33 MHZ
0110	1.14 MHZ
0111	1 MHZ
1000	0.89 MHZ
1001	0.8 MHZ
1010	0.73 MHZ
1011	0.67 MHZ
1100	0.62 MHZ
1101	0.57 MHZ
1110	0.53 MHZ
1111	0.5M HZ

20h~2Ah KEY0~KEY10 Variation Value Register (Read Only)

Bit	D7	D6:D0
Name	SIGN	KEYx_ΔCOUNT[6:0]
Default	0	000 0000

SIGB	Sign bit
0	Positive
1	Negative
KEYx_ΔCOUNT[6:0]	Key Value Count

30h~3Ah KEY0~KEY10 Threshold Set Register

Bit	D7	D6:D0
Name	-	KEYx_TH[6:0]
Default	0	011 0000

KEYx_TH[6:0]	Key Threshold
0~127	

40h, 42h ... 52h, 54h KEY0~KEY10 Calibration Low Byte Register (Read Only)

Bit	D7:D0
Name	KEY0_CAL_L
Default	0000 0000

41h, 43h ... 53h, 55h KEY0~KEY10 Calibration High Byte Register (Read only)

Bit	D7:D0
Name	KEY0_CAL_H
Default	0000 0000

60h GPIO Enable Register 1

Bit	D7:D0
Name	GPIOEN[7:0]
Default	0000 0000

IS31FL3801

61h GPIO Enable Register 2

Bit	D7:D3	D2:D0
Name	-	GPIOEN[10:8]
Default	0000 0	000

GPIOEN[10:0] Enable KEY0~KEY10 GPIO Mode
 0 Disable Touch key channel enter GPIO Mode
 1 Enable Touch key channel enter GPIO Mode; A channel cannot be a Touch key or Slider sensor while it's was set to be a GPIO.

62h GPIO Value Register 1

Bit	D7:D0
Name	GPV[7:0]
Default	0000 0000

63h GPIO Value Register 2

Bit	D7:D3	D2:D0
Name	-	GPV[10:8]
Default	0000 0	000

GPV[10:0] 62h and 63h registers define the KEY0~KEY10 GPIO values.
 0 GPIO = 0, if the related Enable GPIO Register 1/2 is enabled.
 1 GPIO = 1, if the related Enable GPIO Register 1/2 is enabled.

64h Slider Enable Register 1

Bit	D7:D0
Name	SLEN[7:0]
Default	1110 0000

65h Slider Enable Register 2

Bit	D7:D3	D2:D0
Name	-	SLEN[10:8]
Default	0000 0	111

SLEN[10:0] Enable KEY0~KEY10 Slider Mode
 0 Disable Touch key channel enter Slider Mode
 1 Enable Touch key channel enter Slider Mode; A channel cannot be a Touch key sensor or GPIO while it's was set to be a Slider.

A slider is composed of six Touch Key sensors. Users can use a GUI to select certain Touch Key sensors.

66h Slider Status Register1 (Read Only)

Bit	D7	D6:D0
Name	ACT	Initial position[6:0]
Default	0	000 0000

ACT Indicator.
 0 No action
 1 Activated
 Initial position[6:0] The initial position of slider

IS31FL3801

67h Slider Status Register2 (Read Only)

Bit	D7	D6:D0
Name	Direction	End position[6:0]
Default	0	000 0000

Direction Direction of slider.
0 Rotated to left.
1 Rotated to right
End position[6:0] The end position of slider

68h Slider Status Register3

Bit	D7	D6:D0
Name	STA	Duration[6:0]
Default	1	000 0000

STA Status of slider.
0 Wheel mode
1 Slider mode
Duration[6:0] Duration from initial position to end position

69h Key position 1-2 of Slider1

Bit	D7:D4	D3:D0
Name	S1K1[3:0]	S1K2[3:0]
Default	0101	0110

S1Kx[3:0] This register shows which Key represents Slider1 the first Key, S1K1, and the second Key S1K2.

6Ah Key position 3-4 of Slider1

Bit	D7:D4	D3:D0
Name	S1K3[3:0]	S1K4[3:0]
Default	0111	1000

S1Kx[3:0] This register shows which Key represents Slider1 the third Key S1K3, and the fourth key S1K4.

6Bh Key position 5-6 of Slider1

Bit	D7:D4	D3:D0
Name	S1K5[3:0]	S1K6[3:0]
Default	1001	1010

S1Kx[3:0] This register shows which Key represents Slider1 the fifth Key S1K5, and the sixth key S1K6.

6Fh Version Control Register (Read Only)

Bit	D7:D6	D5:D3	D2:D0
Name	VCR1[1:0]	VCR2[2:0]	VCR3[2:0]
Default	01	000	000

VCRx This register shows the firmware version.
VCR1[1:0] The major modification that cannot compatible with previous version
VCR2[2:0] Added functions and the functions should be backward compatible.
VCR3[2:0] Shows the bug modification and the revision should be backward compatible.

IS31FL3801

70h~75h Slider Calibration Register 1-6

Bit	D7:D0
Name	SCRKx
Default	0001 0101

SCRKx[3:0] These registers are used for slider calibration. The slider is composed of six touch keys. The range of x is from 1 to 6 which means as key 1 to key 6.

76h Spread Spectrum Configuration Register

Bit	D7:D4	D3:D2	D1:D0
Name	SSR[3:0]	SSA[1:0]	-
Default	0000	00	-

SSC Spread spectrum configuration register. Spread spectrum is a technique by which electromagnetic energy produced over a particular bandwidth is spread in the frequency domain. Two parameters are listed as follows:

SSR[3:0] SSR[3:0] defines the spread spectrum sweep rate. If the SCR[3:0] = 0, then spread spectrum is disabled.

SSA[1:0] SSA[1:0] defines the amplitude of spread spectrum frequency change. The frequency is changed by adding SSA[1:0] range to the actual internal OSC control register.

11 +/- 32
 10 +/- 16
 01 +/- 8
 00 +/- 4

IS31FL3801

CLASSIFICATION REFLOW PROFILES

Profile Feature	Pb-Free Assembly
Preheat & Soak	
Temperature min (T _{sm})	150°C
Temperature max (T _{sm})	200°C
Time (T _{sm} to T _{sm}) (t _s)	60-120 seconds
Average ramp-up rate (T _{sm} to T _p)	3°C/second max.
Liquidous temperature (T _L)	217°C
Time at liquidous (t _L)	60-150 seconds
Peak package body temperature (T _p)*	Max 260°C
Time (t _p)** within 5°C of the specified classification temperature (T _c)	Max 30 seconds
Average ramp-down rate (T _p to T _{sm})	6°C/second max.
Time 25°C to peak temperature	8 minutes max.

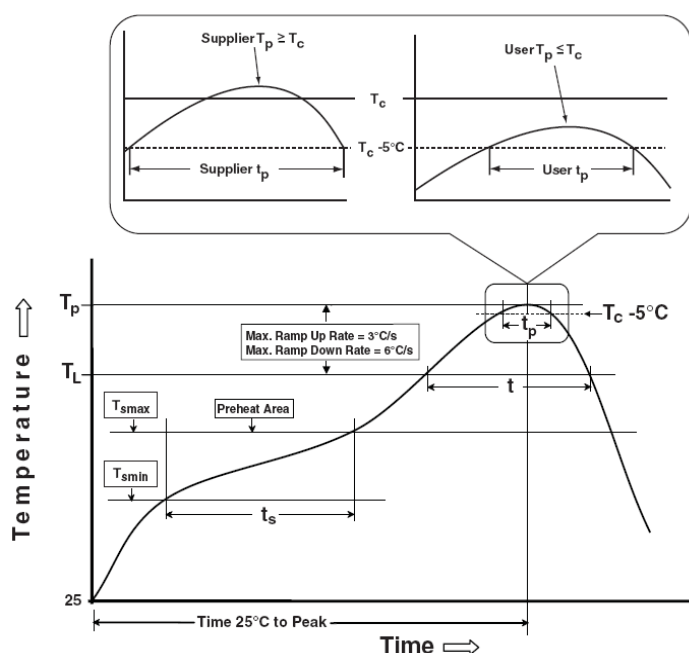

Figure 8 Classification Profile

IS31FL3801

PACKAGE INFORMATION

QFN-60

RECOMMENDED LAND PATTERN

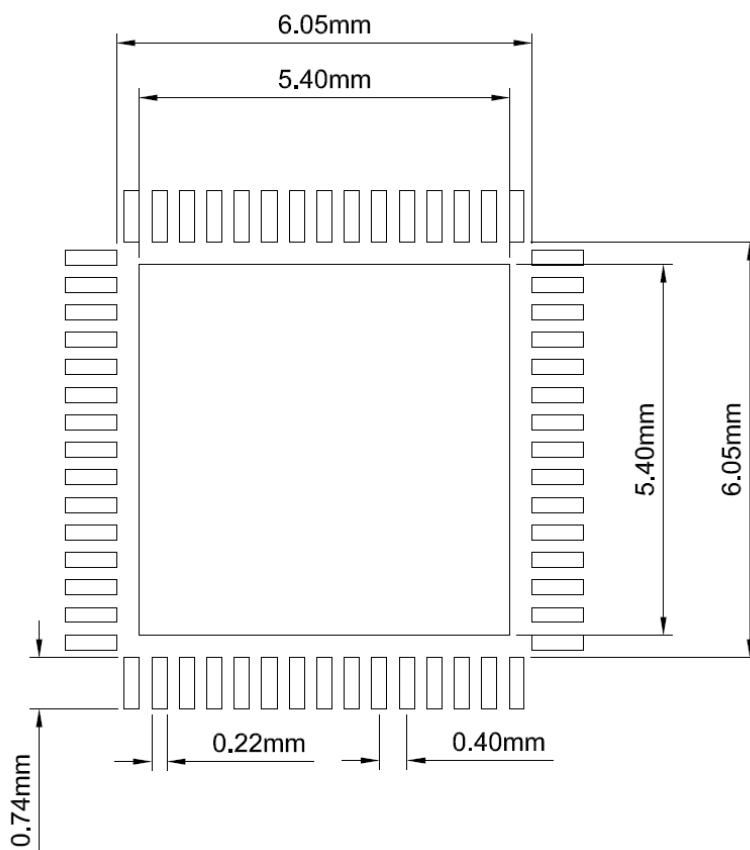

IS31FL3801

POD

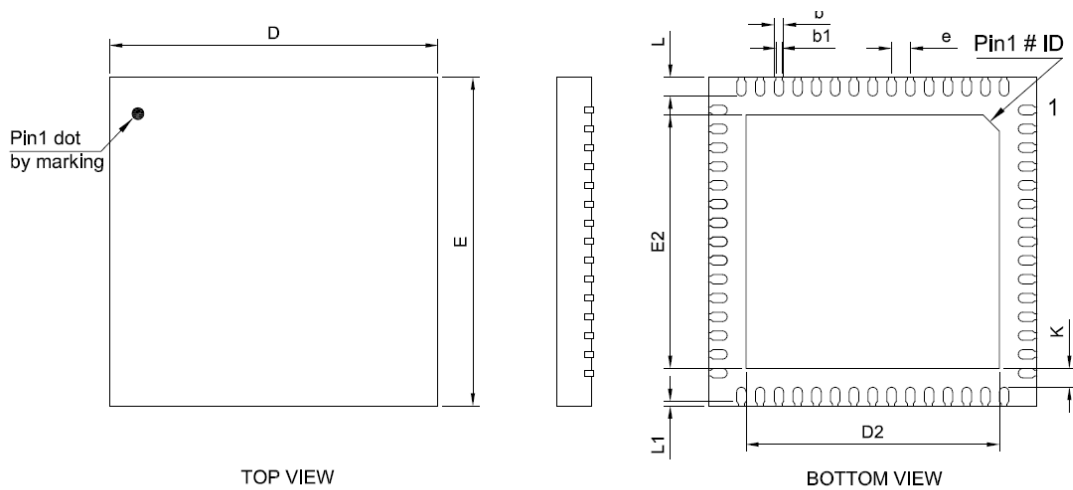

SYM BOL	MILLIMETER		
	MIN	NOM	MAX
A	0.70	0.75	0.80
A1	0.00	0.02	0.05
A3	0.20REF		
b1	0.125REF		
b	0.15	0.20	0.25
D	6.90	7.00	7.10
E	6.90	7.00	7.10
D2	4.95	-	5.55
E2	4.95	-	5.55
L	0.30	0.40	0.50
L1	0.10REF		
e	0.40BSC		
K	0.20	-	-

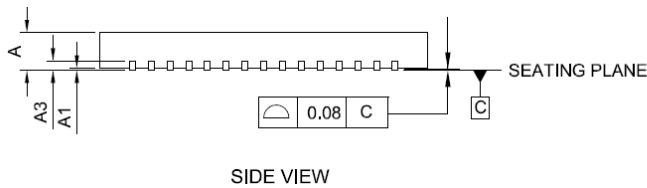

NOTE:

1. CONTROLLING DIMENSION: MM
2. REFERENCE DOCUMENT: JEDEC MO-220
3. THE PIN'S SHARP AND THERMAL PAD SHOWS DIFFERENT SHAPE AMONG DIFFERENT FACTORIES determine suitability for use.

IS31FL3801

REVISION HISTORY

Revision	Detail Information	Date
0A	Initial version. Modified it from IS31FL3800.	2020.05.26
0B	Modified 0B version from IS31FL3800 version C.	2020.08.10