

PAGE 1/2

ISSUE 11-04-17

SERIE : DPDT

PART NUMBER : R577043035

## RF CHARACTERISTICS

Frequency range : **0 - 3 GHz**  
Impedance : **50 Ohms**

Frequency (GHz)	DC - 1	1 - 2	2 - 3
VSWR max	<b>1.15</b>	<b>1.20</b>	<b>1.25</b>
Insertion loss max	<b>0.15 dB</b>	<b>0.20 dB</b>	<b>0.25 dB</b>
Isolation min	<b>85 dB</b>	<b>80 dB</b>	<b>75 dB</b>
Average power (*)	<b>700 W</b>	<b>500 W</b>	<b>400 W</b>

## ELECTRICAL CHARACTERISTICS

Actuator : **LATCHING**  
Nominal current \*\* : **125 mA**  
Actuator voltage (Vcc) : **28V (24 to 30V) / NEGATIVE COMMON**  
Terminals : **9 pins D-SUB male connector**  
Indicator rating : **1 W / 30 V / 100 mA**

## MECHANICAL CHARACTERISTICS

Connectors : **N female per MIL-C 39012**  
Life : **2.5 million cycles**  
Switching Time\*\*\* : **< 15 ms**  
Construction : **Splashproof**  
Weight : **< 215 g**

## ENVIRONMENTAL CHARACTERISTICS

Operating temperature range : **-40°C to +85°C**  
Storage temperature range : **-55°C to +85°C**

(\* Average power at 25°C per RF Path)

(\*\* At 25° C ±10%)

(\*\*\* Nominal voltage ; 25° C)



PAGE 2/2

ISSUE 11-04-17

SERIE : DPDT

PART NUMBER : R577043035

**DRAWING**

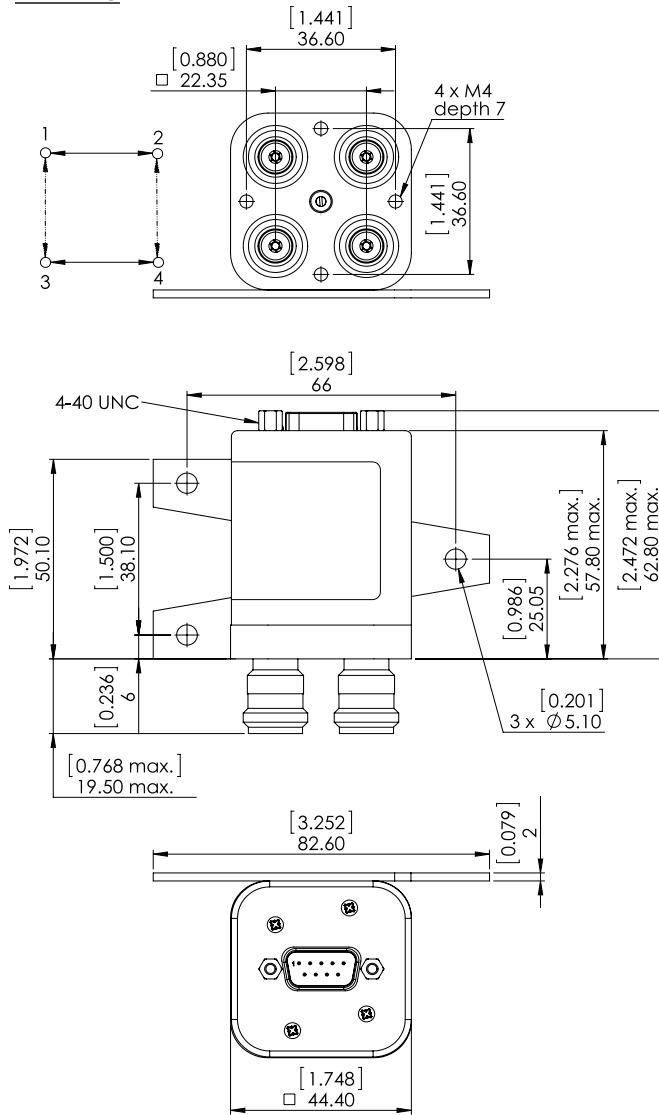

General tolerances : ±0,5 mm [0,02 in]



**LABEL**

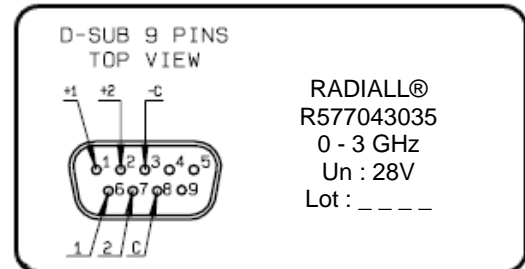

**SCHEMATIC DIAGRAM**

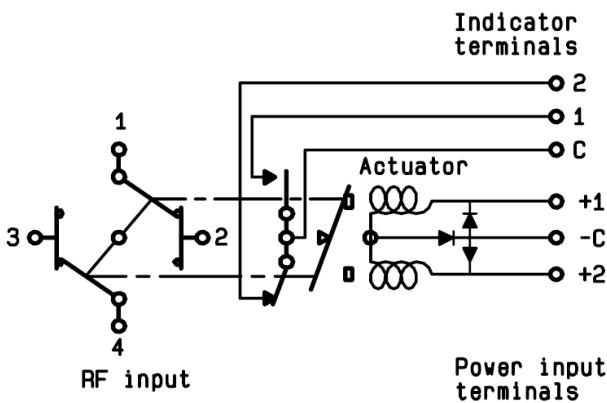

Voltage	RF Continuity	Ind.
-C +1	1 ↔ 3 / 2 ↔ 4	C.1
-C +2	1 ↔ 2 / 3 ↔ 4	C.2