



ABSTRACT

This user's guide describes the TPS23758 evaluation module (EVM). The TPS23758 evaluation module (TPS23758EVM-080) contains evaluation and reference circuitry for the TPS23758 device. The TPS23758 device is an IEEE 802.3at Type 1 compliant, powered-device (PD) controller and power supply controller optimized for primary side regulation flyback converter topologies. The TPS23758EVM-080 is targeted for a 5-V synchronous-rectified high efficiency 13-W PD solution.

Table of Contents

1 Introduction	2
2 Electrical Specifications	2
3 Description	3
4 Schematic	4
5 General Configuration and Description	5
6 TPS23758EVM-080 Performance Data	6
7 EVM Assembly Drawings and Layout Guidelines	12
8 Bill of Materials	16
9 Revision History	21

List of Figures

Figure 4-1. TPS23758EVM-080 Schematic.....	4
Figure 6-1. Startup Response When Connected to a PoE PSE (TPS23880).....	6
Figure 6-2. DCDC Startup.....	6
Figure 6-3. Transient Response from 100 mA to 1 A for a 48-V Input.....	7
Figure 6-4. Efficiency of the TPS23758EVM-080.....	8
Figure 6-5. TPS23758EVM-080 Load Regulation.....	9
Figure 6-6. DCDC Recovery from Output Short.....	9
Figure 6-7. SRF = 0 Ω	10
Figure 6-8. SRF = 100 Ω	10
Figure 6-9. SRR = 0 Ω	11
Figure 6-10. SRR = 10 Ω	11
Figure 7-1. Top-Side Component Placement.....	12
Figure 7-2. Layer 2 Routing.....	12
Figure 7-3. Layer 3 Routing.....	13
Figure 7-4. Bottom-Side Routing.....	13

List of Tables

Table 2-1. TPS23758EVM-080 Electrical and Performance Specifications at 25°C.....	2
Table 5-1. Connector Functionality.....	5
Table 5-2. Test Points.....	5
Table 8-1. TPS23758EVM-080 BOM.....	16

Trademarks

All trademarks are the property of their respective owners.

1 Introduction

The TPS23758EVM-080 allows reference circuitry evaluation of the TPS23758 device. It contains input and output power connectors and an array of onboard test points for circuit evaluation.

1.1 Features

- IEEE802.3at Type 1 compliant PoE PD
- Class 0 5-V and 2.3-A primary side regulated CCM flyback
- Advanced startup
- Programmable slew rate and frequency dithering for EMI reduction
- Primary-side adapter priority control

1.2 Applications

- IP cameras
- Access points
- Point-of-sale
- Barcode readers
- IP phones
- Wireless LAN- wireless access points

2 Electrical Specifications

Table 2-1. TPS23758EVM-080 Electrical and Performance Specifications at 25°C

PARAMETER	TEST CONDITIONS	MIN	TYP	MAX	UNIT
POWER INTERFACE					
Input voltage	Applied to the power pins of connectors J1	37		57	V
	Applied to the power pins of connectors J4		48		V
Input UVLO, POE input J1	Rising input voltage			36	V
	Falling input voltage	30			
Detection voltage	At device terminals	2.7		10.1	V
Classification voltage	At device terminals	14.5		20.5	V
Classification Current	Class 0	0		4	mA
Inrush current-limit			140		mA
Operating current-limit			550		mA
DC-TO-DC CONVERTER					
Output voltage	$V_{IN} = 48\text{ V}, I_{LOAD} \leq I_{LOAD}(\text{max})$		5		V
Output current	$37\text{ V} \leq V_{IN} \leq 57\text{ V}$		2.3		A
Output ripple voltage peak-to-peak	$V_{IN} = 48\text{ V}, I_{LOAD} = 1\text{ A}$		34		mV
Efficiency, end-to-end	$V_{IN} = 48\text{ V}, I_{LOAD} = 230\text{ mA}$		61		%
	$V_{IN} = 48\text{ V}, I_{LOAD} = 1.15\text{ A}$		85		
	$V_{IN} = 48\text{ V}, I_{LOAD} = 2.3\text{ A}$		87		
Switching frequency			250		kHz

3 Description

The TPS23758EVM-080 enables full evaluation of the TPS23758 device. Refer to the schematic shown in [Figure 4-1](#). Ethernet power is applied from J1 and is dropped to the bridge rectifier (D1, D2). The Power over Ethernet (PoE) transformer needed to transfer power or data is T1. The Bob Smith Terminations help balance the Ethernet cable impedance and are critical for ESD and EMI or EMC performance. The EMI or EMC filter and transient protection for the TPS23758 device are at the output of the diode bridge.

Input power can also be applied at J4 from a DC source when power at J1 is not present.

The TPS23758 (U1) PD and DC-to-DC converter circuitry is shown in [Figure 4-1](#). R17 provides the detection signature. The switched side of the PD controller is to the right of U1. The TPS23758 RTN pin provides inrush limited turn on and charge of the bulk capacitor, C18.

The DC-to-DC converter is a high-efficiency diode rectified primary-side regulated flyback converter.

Output voltage feedback is provided with R19 and R24 on the bias winding. R16 provides a means for error injection to measure the frequency response of the converter.

4 Schematic

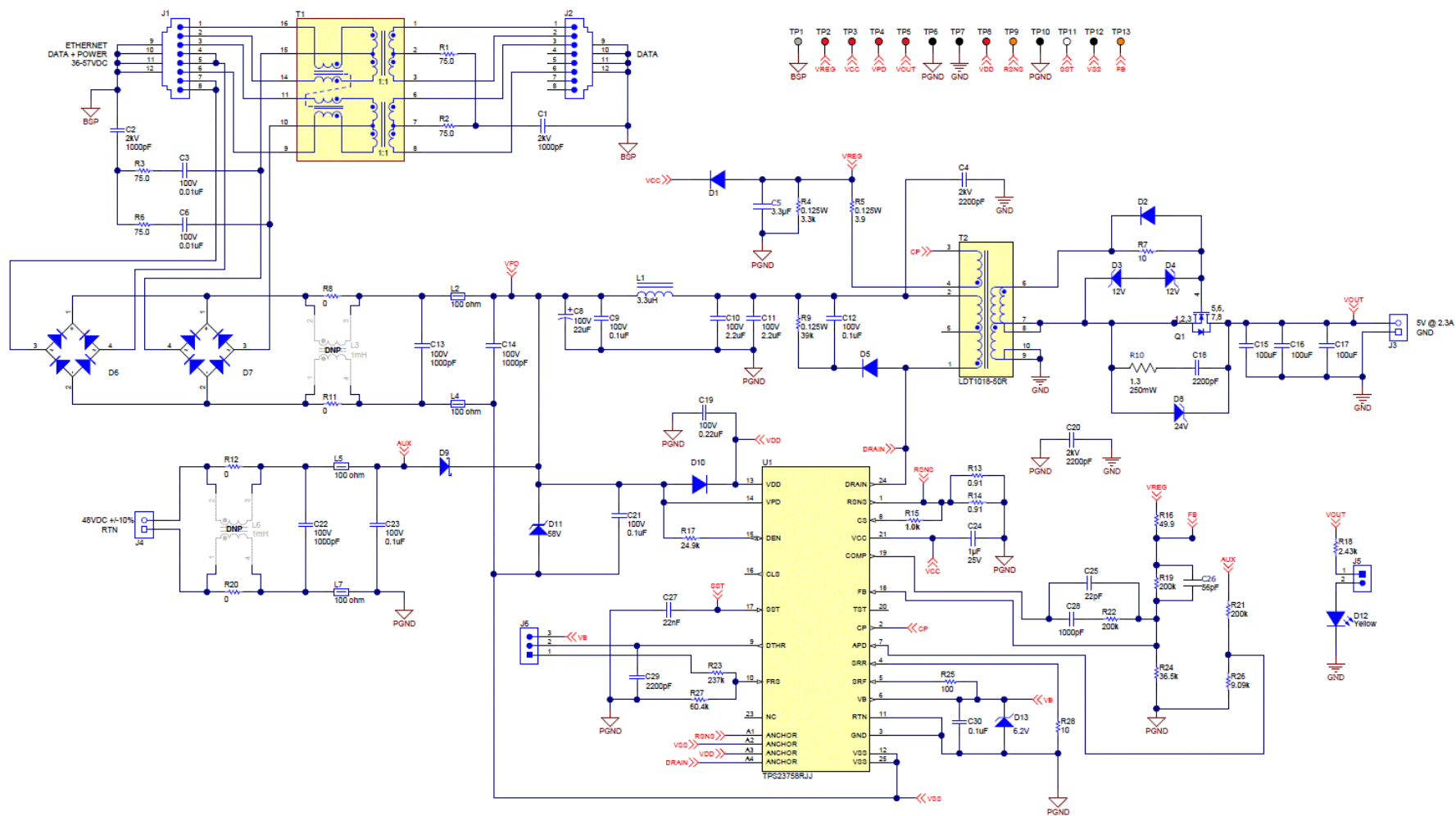

Figure 4-1. TPS23758EVM-080 Schematic

5 General Configuration and Description

5.1 Physical Access

Table 5-1 lists the EVM connector functionality. Table 5-2 describes the test point availability and jumper functionality.

Table 5-1. Connector Functionality

Connector	Label	Description
J1	PWR+DATA	PoE input; connect to PSE power and data source.
J2	DATA	Ethernet data passthrough; connect to downstream Ethernet device.
J3	Output	Output connector to load.
J4	Adapter Input	DC-to-DC converter input bypassing the PoE converter; connect a 12-V adapter.
J5	LED	Jump J4 to visually indicate the output voltage.
J6	FREQ	Jump to 'Fixed' for fixed frequency. Jump to 'Dither' to enable spread spectrum dithering.

Table 5-2. Test Points

Test Point	Label	Description
TP1	BS	Bob Smith termination
TP2	VREG	Bias winding
TP3	VCC	Switching supply voltage
TP4	VPD	Input voltage
TP5	VOUT	Output voltage
TP6, TP10	PGND	Primary ground
TP7	GND	Secondary ground
TP8	VDD	DC-DC converter input
TP9	RSNS	Current sense voltage
TP11	SST	Soft start and hiccup timer
TP12	VSS	PoE input return ground
TP13	FB	Feedback loop

6 TPS23758EVM-080 Performance Data

6.1 Startup to PSE and DCDC Startup

Figure 6-1 shows the startup response of the TPS23758EVM-080.

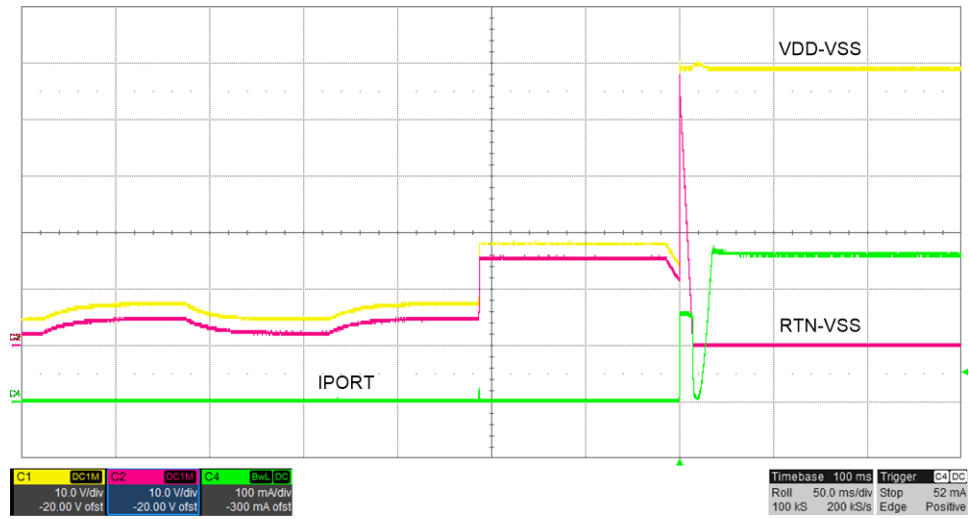

Figure 6-1. Startup Response When Connected to a PoE PSE (TPS23880)

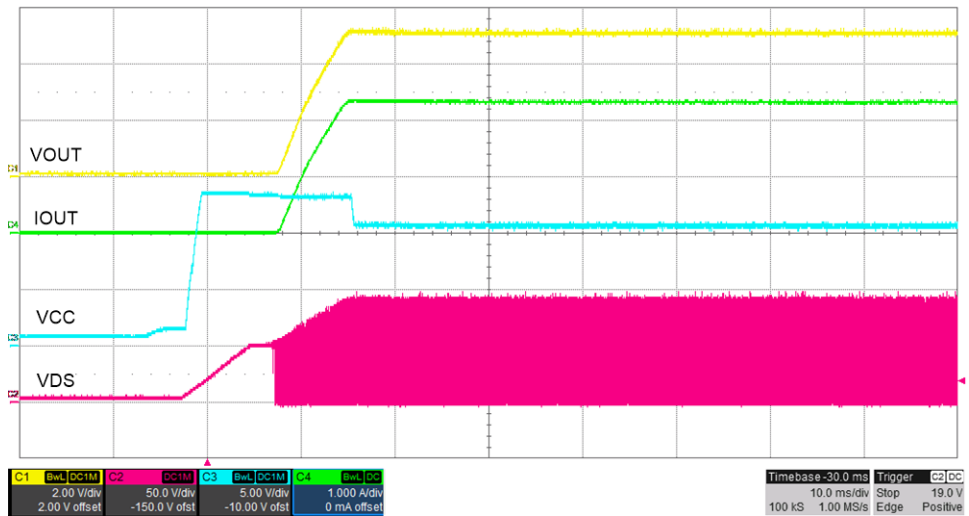

Figure 6-2. DCDC Startup

6.2 Transient Response

Figure 6-3 shows the transient response of the TPS23758EVM-080.

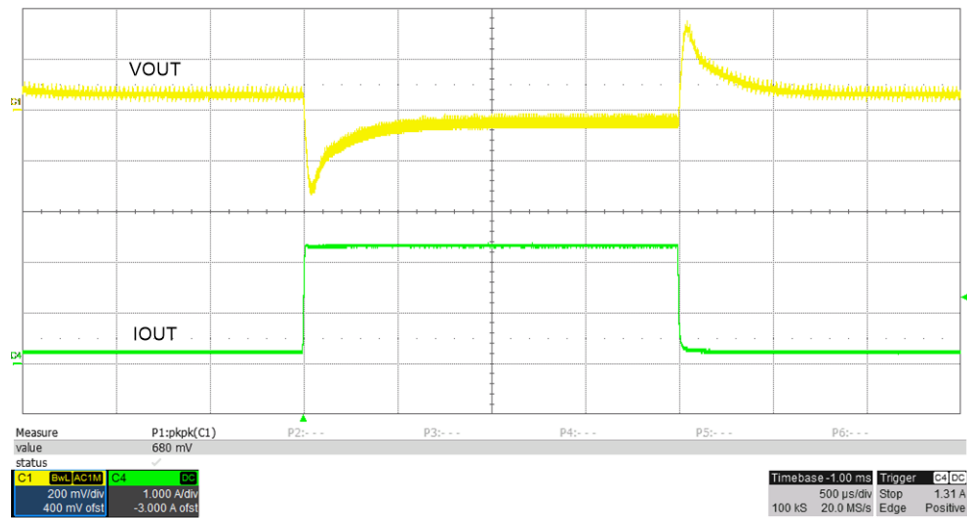

Figure 6-3. Transient Response from 100 mA to 1 A for a 48-V Input

6.3 Efficiency

Figure 6-4 shows the efficiency of the TPS23758EVM-080.

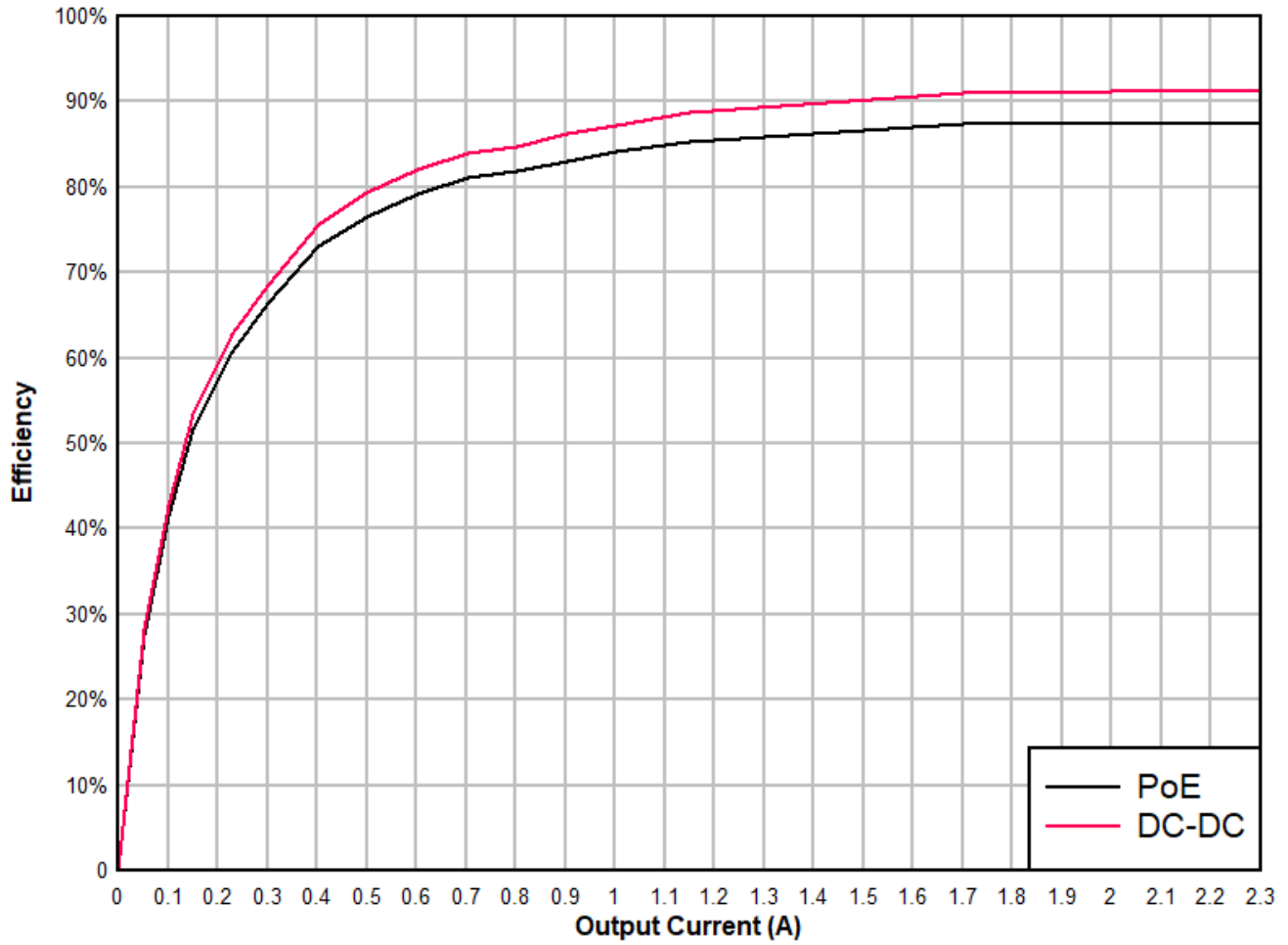

Figure 6-4. Efficiency of the TPS23758EVM-080

6.4 Load Regulation

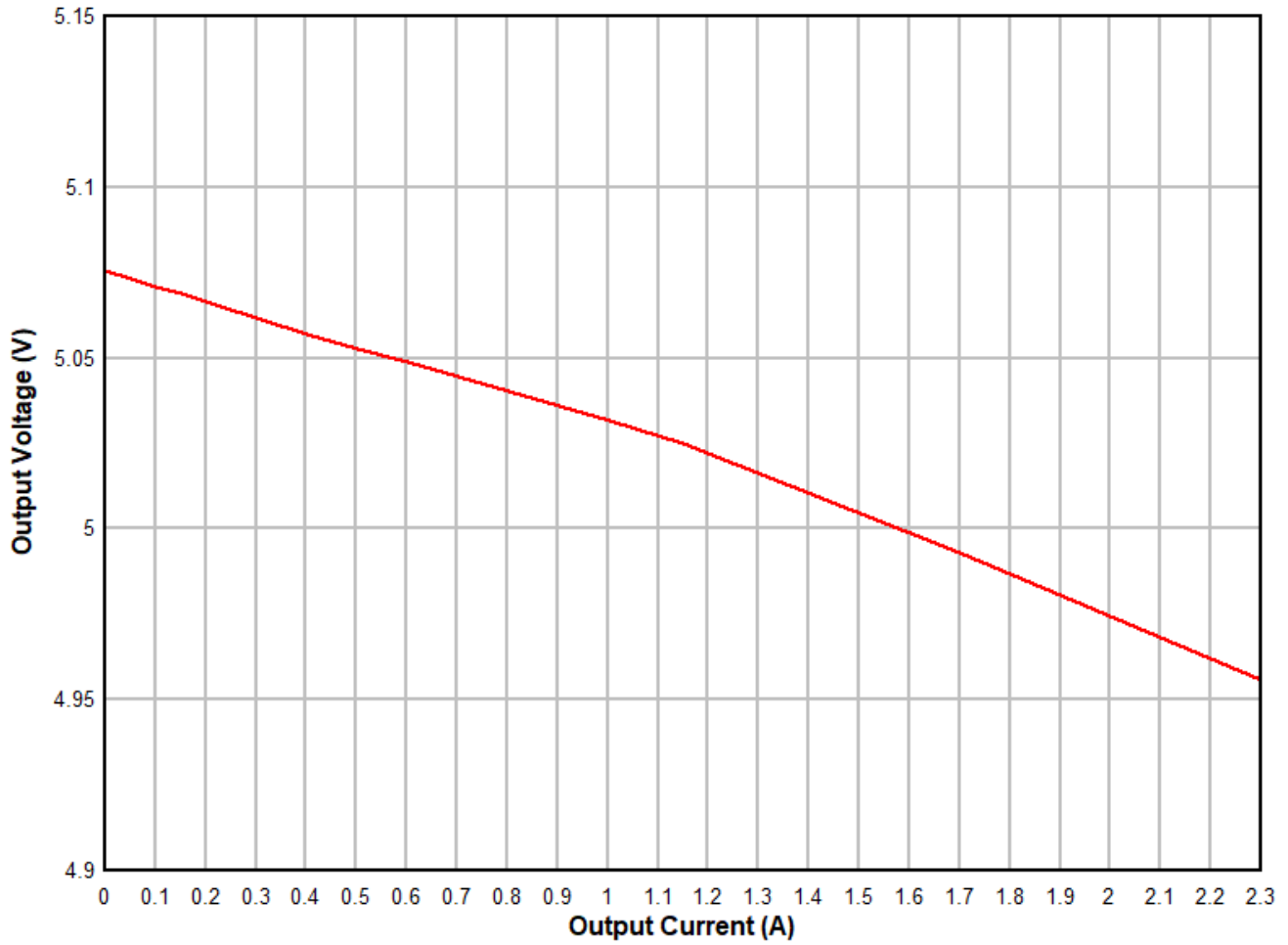

Figure 6-5. TPS23758EVM-080 Load Regulation

6.5 Recovery from VOUT Short

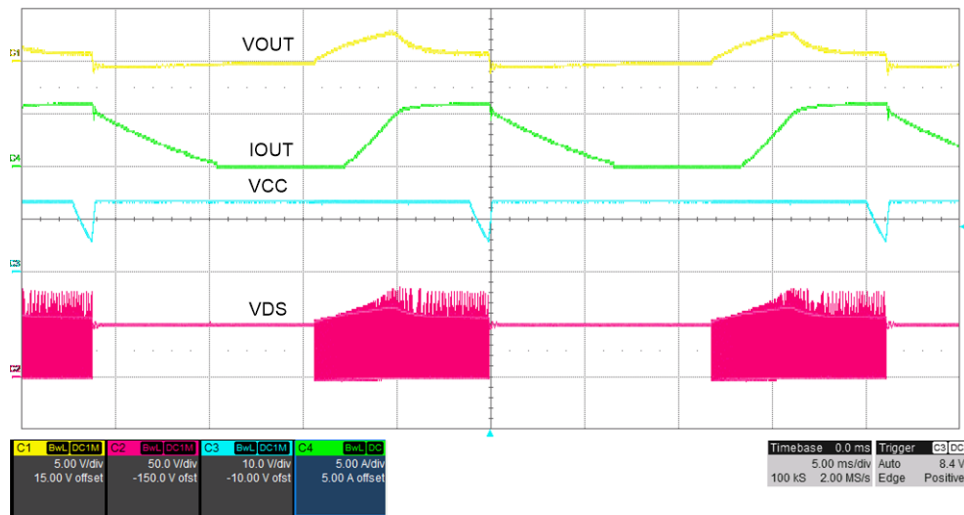

Figure 6-6. DCDC Recovery from Output Short

6.6 Slew Rate Adjust

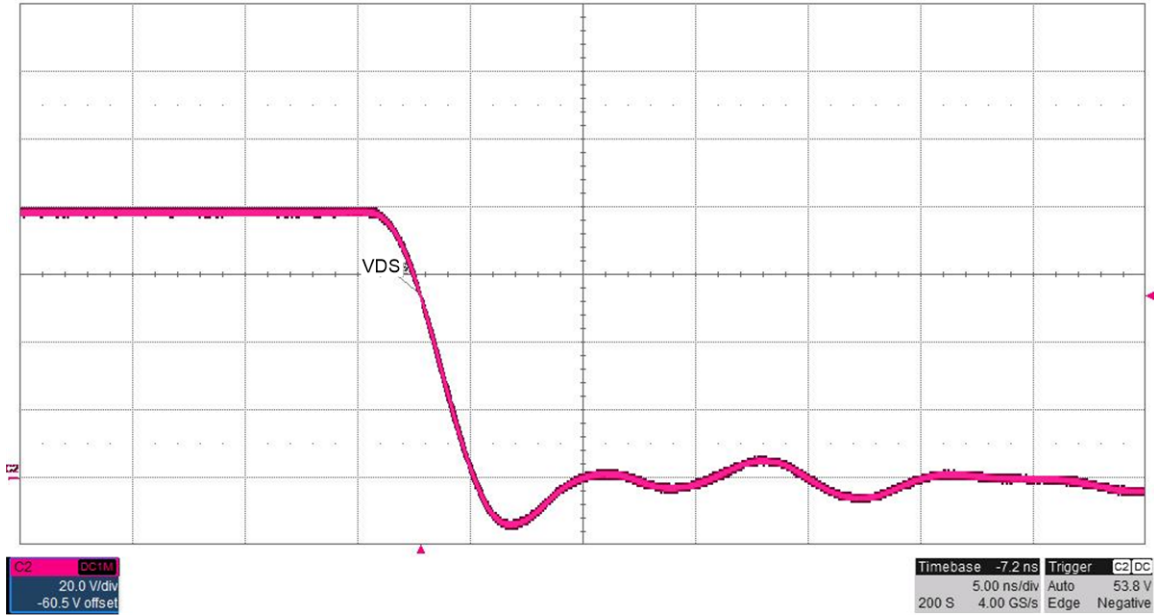

Figure 6-7. SRF = 0 Ω

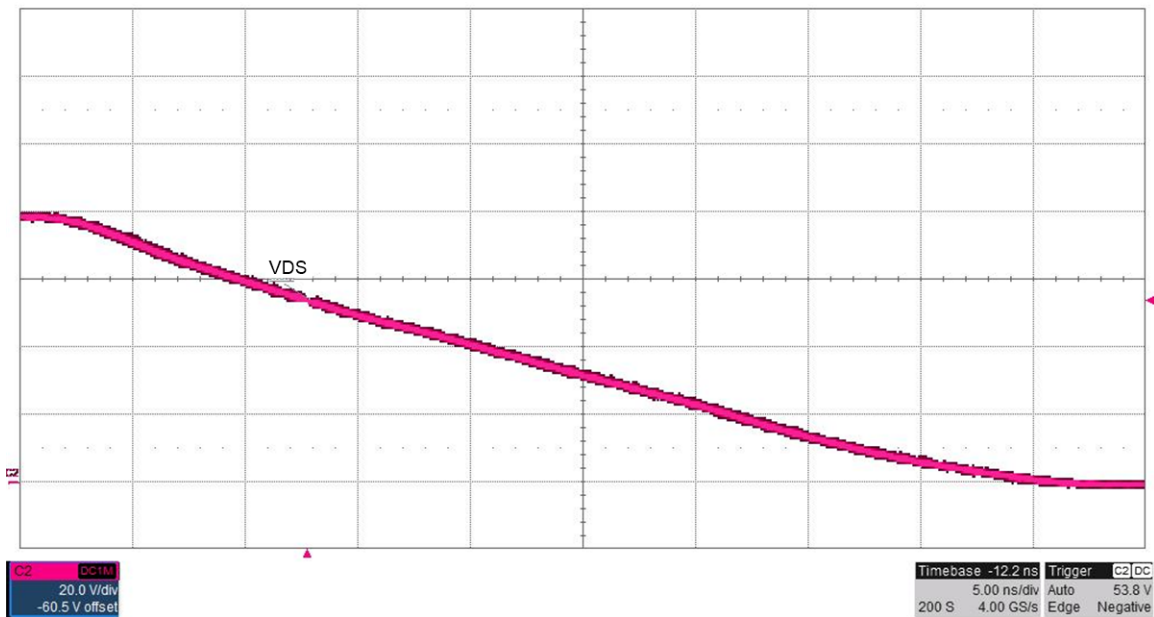

Figure 6-8. SRF = 100 Ω

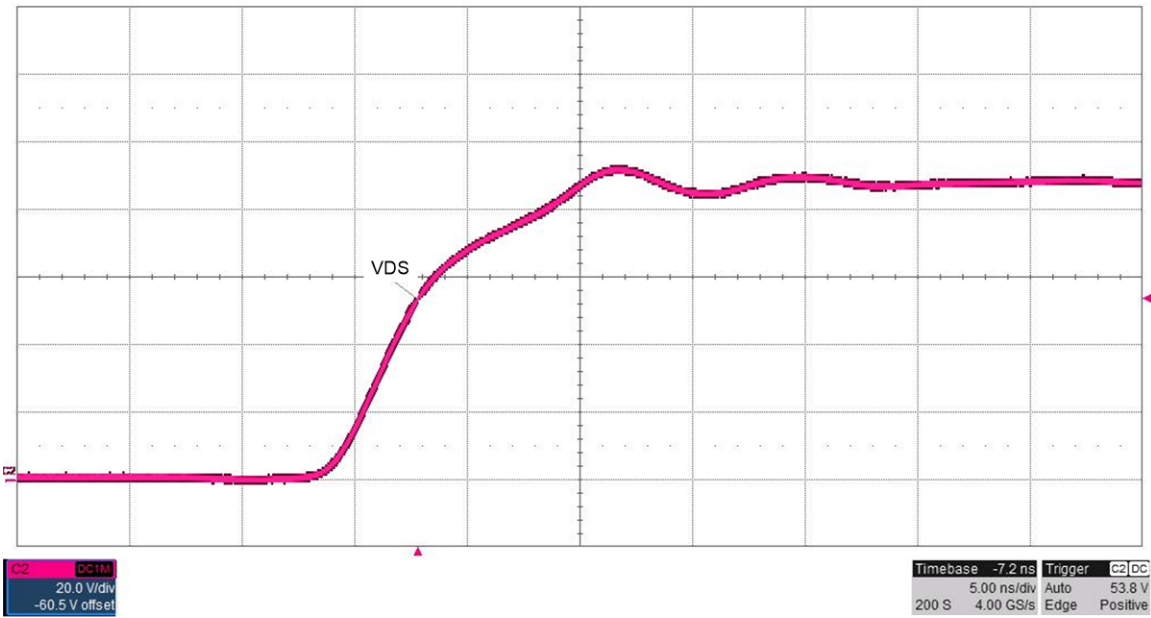

Figure 6-9. SRR = 0 Ω

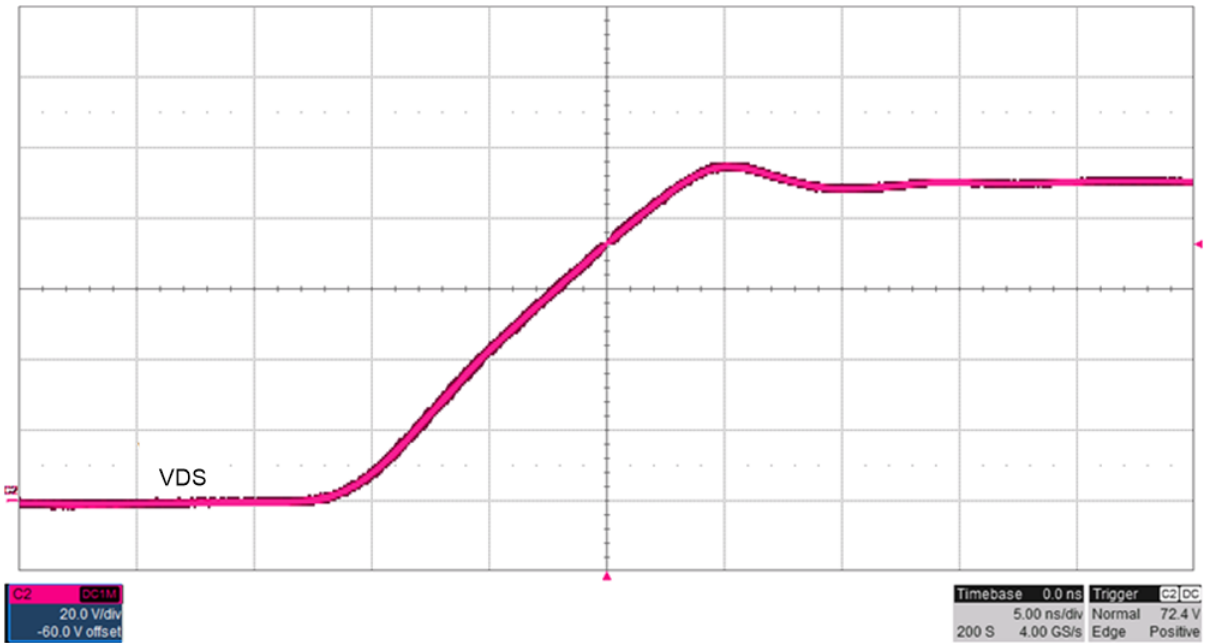

Figure 6-10. SRR = 10 Ω

7 EVM Assembly Drawings and Layout Guidelines

7.1 PCB Drawings

Figure 7-1 to Figure 7-4 show the component placement and layout of the TPS23758EVM-080.

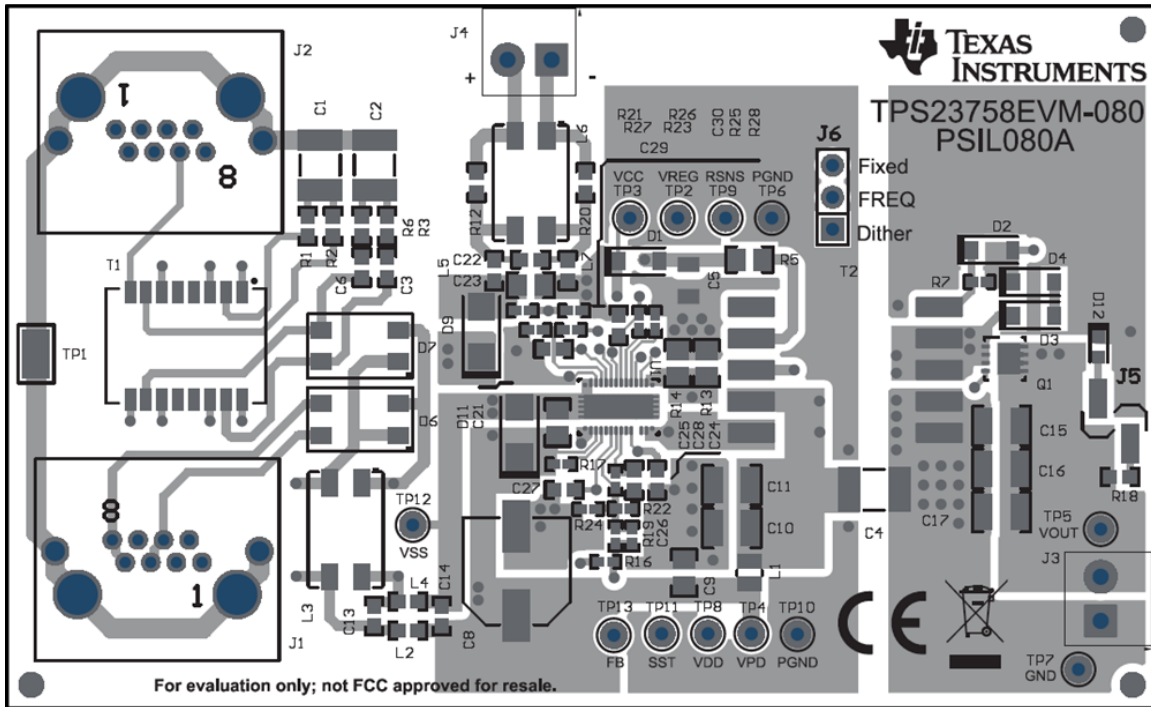

Figure 7-1. Top-Side Component Placement

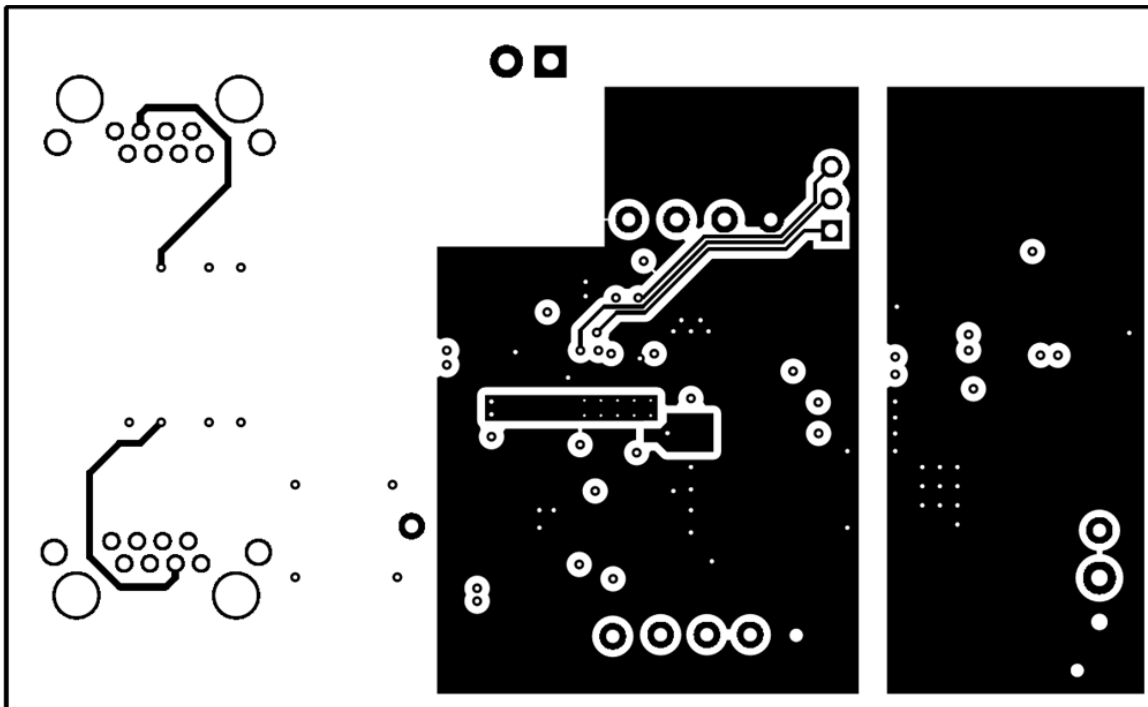

Figure 7-2. Layer 2 Routing

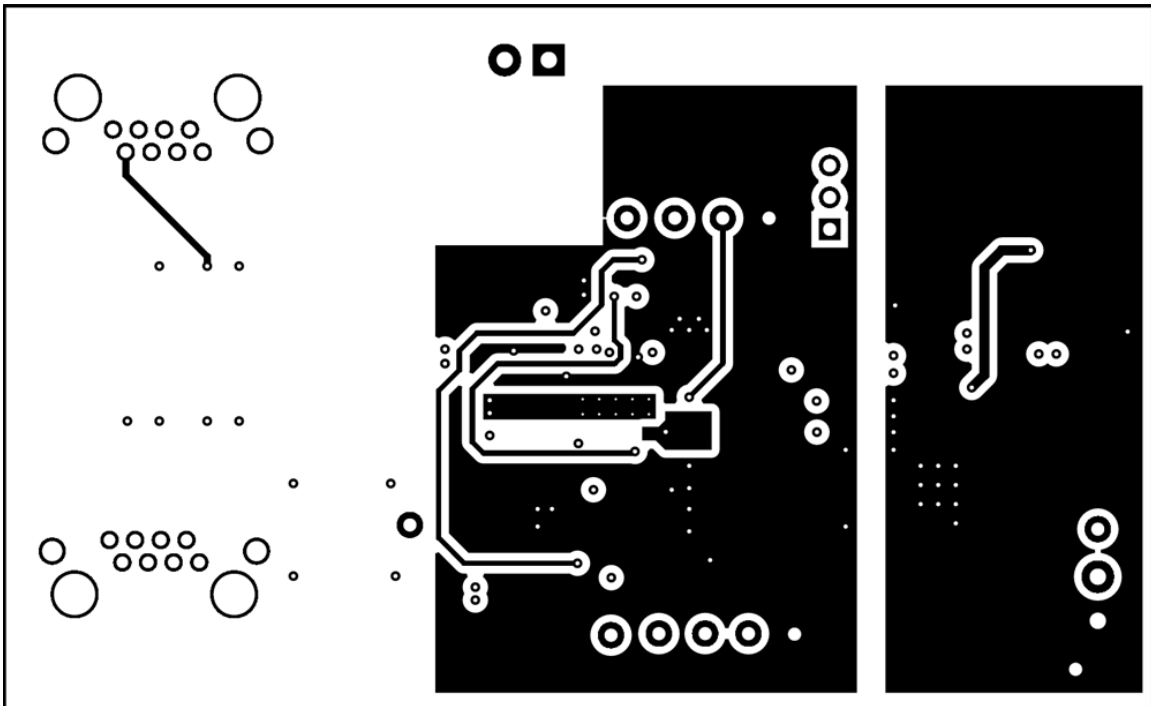

Figure 7-3. Layer 3 Routing

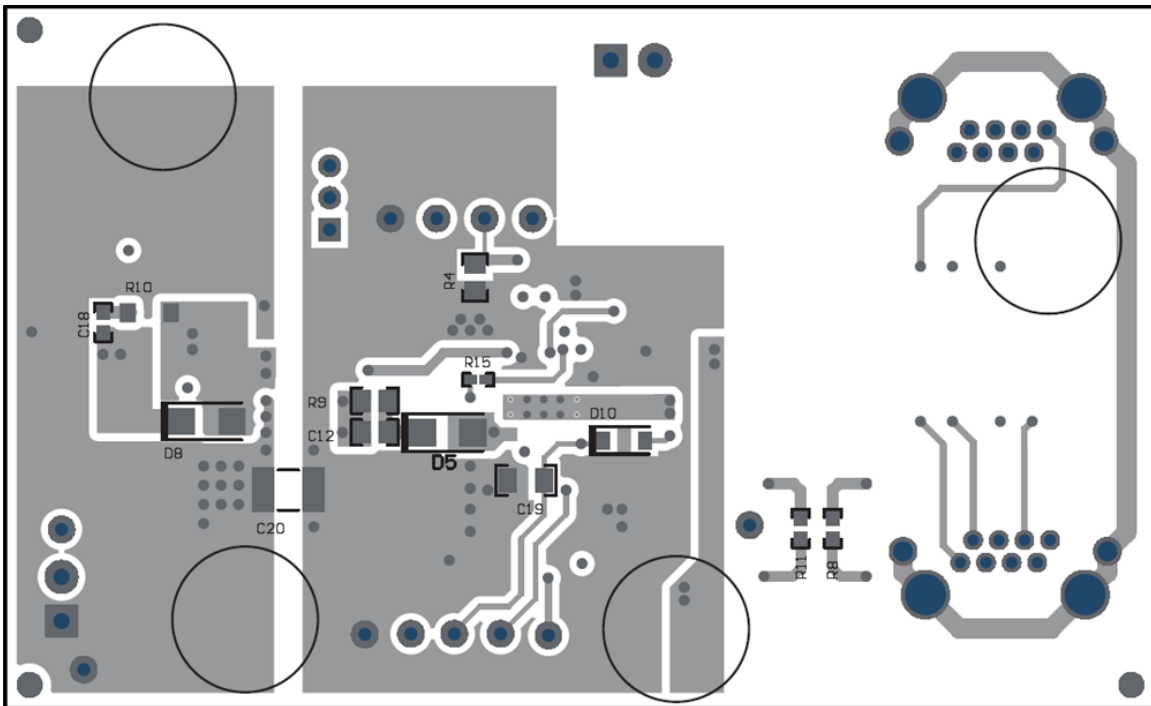

Figure 7-4. Bottom-Side Routing

7.2 Layout Guidelines

The layout of the PoE front end should follow power and EMI or ESD best-practice guidelines. A basic set of recommendations includes:

- Pin 22 of the TPS23758 is omitted from the IC to ensure high voltage clearance from Pin 24 (DRAIN). Therefore, the Pin 22 footprint should be removed when laying out the TPS23758.
- It is recommended having at least 8 vias (VSS) connecting the exposed thermal pad through a top layer plane (2 oz copper recommended) to a bottom VSS plane (2 oz. copper recommended) to help with thermal dissipation.
- The Pin 24 of the TPS23758 should be near the power transformer and the current sense resistor should be close to Pin 1 of the TPS23758 to minimize the primary loop.
- Parts placement must be driven by power flow in a point-to-point manner; RJ-45, Ethernet transformer, diode bridges, TVS and 0.1- μ F capacitor, and TPS23758 converter input bulk capacitor.
- Make all leads as short as possible with wide power traces and paired signal and return.
- No crossovers of signals from one part of the flow to another are allowed.
- Spacing consistent with safety standards like IEC60950 must be observed between the 48-V input voltage rails and between the input and an isolated converter output.
- Use large copper fills and traces on SMT power-dissipating devices, and use wide traces or overlay copper fills in the power path.

The DC-to-DC converter layout benefits from basic rules such as:

- Having at least 4 vias (VDD) near the power transformer pin connected to VDD through multiple layer planes to help with thermal dissipation of the power transformer.
- Having at least 6 vias (secondary ground) near the power transformer pin connected to secondary ground through multiple layer planes to help with thermal dissipation of the power transformer.
- Pair signals to reduce emissions and noise, especially the paths that carry high-current pulses, which include the power semiconductors and magnetics.
- Minimize the trace length of high current power semiconductors and magnetic components.
- Use the ground plane for the switching currents carefully.
- Keep the high-current and high-voltage switching away from low-level sensing circuits including those outside the power supply.
- Proper spacing around the high-voltage sections of the converter.

7.3 EMI Containment

- Use compact loops for dv/dt and di/dt circuit paths (power loops and gate drives).
- Use minimal, yet thermally adequate, copper areas for heat sinking of components tied to switching nodes (minimize exposed radiating surface). Hide copper associated with switching nodes under shielded magnetics, where possible.
- Use copper ground planes (possible stitching) and top-layer copper floods (surround circuitry with ground floods).
- Use a 4-layer PCB, if economically feasible (for better grounding).
- Minimize the amount of copper area associated with input traces (to minimize radiated pickup).
- Heat sink the quiet side of components instead of the switching side, where possible (like the output side of inductor).
- Use Bob Smith terminations, Bob Smith EFT capacitor, and Bob Smith plane. Use Bob Smith plane as a ground shield on input side of PCB (creating a phantom or literal earth ground).
- Use LC filter at DC-to-DC input.
- Dampen high-frequency ringing on all switching nodes, if present (allow for possible snubbers).
- Control rise times with gate-drive resistors and possibly snubbers.
- Switching frequency considerations.
- Use of EMI bridge capacitor across isolation boundary (isolated topologies).
- Observe the polarity dot on inductors (embed noisy end).
- Use of ferrite beads on input (allow for possible use of beads or $0-\Omega$ resistors).
- Maintain physical separation between input-related circuitry and power circuitry (use ferrite beads as boundary line).
- Balance efficiency versus acceptable noise margin.
- Possible use of common-mode inductors.
- Possible use of integrated RJ-45 jacks (shielded with internal transformer and Bob Smith terminations).
- End-product enclosure considerations (shielding).

8 Bill of Materials

Table 8-1 details the EVM bill of materials.

Table 8-1. TPS23758EVM-080 BOM

Designator	Quantity	Value	Description	PackageReference	PartNumber	Manufacturer	Alternate PartNumber	Alternate Manufacturer
!PCB1	1		Printed Circuit Board		PSIL080	Any		
C1, C2	2	1000 pF	CAP, CERM, 1000 pF, 2000 V, +/- 10%, X7R, 1812	1812	1812GC102KAT1A	AVX		
C3, C6	2	0.01 uF	CAP, CERM, 0.01 uF, 100 V, +/- 10%, X7R, 0603	0603	06031C103KAT2A	AVX		
C4, C20	2	2200 pF	CAP, CERM, 2200 pF, 2000 V, +/- 10%, X7R, 1812	1812	C4532X7R3D222K130KA	TDK		
C5	1		CAP CER 3.3 UF 25 V X7R 1206	1206	CL31B335KAHV PNE	Samsung		
C8	1	22 uF	CAP, AL, 22 uF, 100 V, +/- 20%, 1.3 ohm, AEC-Q200 Grade 2, SMD	SMT Radial F	EEE-FK2A220P	Panasonic		
C9, C12, C21, C23	4	0.1 uF	CAP, CERM, 0.1 uF, 100 V, +/- 10%, X7R, 0805	0805	C2012X7R2A104K125AA	TDK		
C10, C11	2	2.2 uF	CAP, CERM, 2.2 uF, 100 V, +/- 10%, X7R, AEC-Q200 Grade 1,		CGA6N3X7R2A25K230AB	TDK		
C13, C14, C22	3	1000 pF	CAP, CERM, 1000 pF, 100 V, +/- 10%, X7R, 0603	0603	C1608X7R2A102K080AA	TDK		
C15, C16, C17	3	100 uF	CAP, CERM, 100 uF, 10 V, +/- 20%, X5R, 1210	1210	GRM32ER61A107ME20L	MuRata		
C18, C29	2	2200 pF	CAP, CERM, 2200 pF, 50 V, +/- 10%, X7R, 0603	0603	C0603C222K5RAC	Kemet		
C19	1	0.22 uF	CAP, CERM, 0.22 uF, 100 V, +/- 10%, X7R, 1206	1206	C3216X7R2A224K115AA	TDK		

Table 8-1. TPS23758EVM-080 BOM (continued)

Designator	Quantity	Value	Description	PackageReference	PartNumber	Manufacturer	Alternate PartNumber	Alternate Manufacturer
C24	1	1 uF	CAP, CERM, 1 uF, 25 V, +/- 10%, X7R, AEC-Q200 Grade 1, 0603	0603	GCM188R71E10 5KA64D	MuRata		
C25	1	22 pF	CAP, CERM, 22 pF, 50 V, +/- 5%, C0G/ NP0, AEC-Q200 Grade 1, 0402	0402	CGA2B2NP01H2 20J050BA	TDK		
C26	1		Cap Ceramic 56pF 50V C0G 5% SMD 0402 125C Paper T/R	0402 (1005 Metric)	CL05C560JB5N NNC	Samsung		
C27	1	0.022 uF	CAP, CERM, 0.022 uF, 16 V, +/- 10%, X7R, 0603	0603	C0603C223K4R ACTU	Kemet		
C28	1	1000 pF	CAP, CERM, 1000 pF, 50 V, +/- 5%, X7R, 0603	0603	CL10C102JB8N NNC	Samsung Electro-Mechanics		
C30	1	0.1 uF	CAP, CERM, 0.1 uF, 25 V, +/- 10%, X7R, AEC-Q200 Grade 1, 0603	0603	CGA3E2X7R1E1 04K080AA	TDK		
D1, D2, D10	3	100 V	Diode, Switching, 100 V, 0.2 A, SOD-123	SOD-123	MMSD4148T1G	ON Semiconductor		
D3, D4	2	12 V	Diode, Zener, 12 V, 500 mW, SOD-123	SOD-123	MMSZ5242B-7-F	Diodes Inc.		
D5	1	200 V	Diode, Ultrafast, 200 V, 1 A, SMA	SMA	MURA120T3G	ON Semiconductor		
D6, D7	2	100 V	Diode, Switching-Bridge, 100 V, 0.8 A, MiniDIP	MiniDIP	HD01-T	Diodes Inc.		
D8	1	24 V	Diode, Zener, 24 V, 1 W, SMA	SMA	SMAZ24-13-F	Diodes Inc.		
D9	1	100 V	Diode, Schottky, 100 V, 1 A, SMA	SMA	B1100-13-F	Diodes Inc.		
D11	1	58 V	Diode, TVS, Uni, 58 V, SMA	SMA	SMAJ58A-13-F	Diodes Inc.		
D12	1	Yellow	LED, Yellow, SMD	LED_0603	150060YS75000	Würth Elektronik		
D13	1	6.2 V	Diode, Zener, 6.2 V, 500 mW, SOD-123	SOD-123	MMSZ5234B-7-F	Diodes Inc.		

Table 8-1. TPS23758EVM-080 BOM (continued)

Designator	Quantity	Value	Description	PackageReference	PartNumber	Manufacturer	Alternate PartNumber	Alternate Manufacturer
H1, H2, H3, H4	4		Bumpon, Hemisphere, 0.44 X 0.20, Clear	Transparent Bumpon	SJ-5303 (CLEAR)	3M		
J1, J2	2		RJ45, No LED, tab up, R/A, TH	16.26 x 14.54 x 15.75	1-406541-1	TE Connectivity		
J3, J4	2		Terminal Block, 3.5 mm Pitch, 2x1, TH	7.0 x 8.2 x 6.5 mm	ED555/2DS	On-Shore Technology		
J5	1		Header, 2.54 mm, 2 x 1, Gold, R/A, SMT	Header, 2.54 mm, 2 x 1, R/A, SMT	878980204	Molex		
J6	1		Header, 100 mil, 3x1, Gold, TH	PBC03SAAN	PBC03SAAN	Sullins Connector Solutions		
L1	1	3.3 uH	Inductor, Shielded, Composite, 3.3 uH, 0.72 A, 0.28 ohm, SMD	SMD, 2.2 x 1.45 mm	PFL2015-332ME B	Coilcraft		
L2, L4, L5, L7	4	100 ohm	Ferrite Bead, 100 ohm @ 100 MHz, 1 A, 0603	0603	MPZ1608D101B TD25	TDK		
Q1	1	30 V	MOSFET, N-CH, 30 V, 20 A, DNH0008A (VSONP-8)	DNH0008A	CSD17579Q3A	Texas Instruments		None
R1, R2, R3, R6	4	75.0	RES, 75.0, 1%, 0.1 W, 0603	0603	RC0603FR-0775 RL	Yageo America		
R4	1	3.3 k	RES, 3.3 k, 5%, 0.125 W, 0805	0805	ERJ-6GEYJ332V	Panasonic		
R5	1	3.9	RES, 3.9, 5%, 0.125 W, AEC-Q200 Grade 0, 0805	0805	CRCW08053R90 JNEA	Vishay-Dale		
R7, R28	2	10	RES, 10, 5%, 0.063 W, AEC-Q200 Grade 0, 0402	0402	CRCW040210R0 JNED	Vishay-Dale		
R8, R11, R12, R20	4	0	RES, 0, 5%, 0.1 W, 0603	0603	ERJ-3GEY0R00 V	Panasonic		
R9	1	39 k	RES, 39 k, 5%, 0.125 W, 0805	0805	ERJ-6GEYJ393V	Panasonic		
R10	1		RES SMD 1.3 OHM 5% 1/4W 1206	1206	ERJ-8GEYJ1R3V	Panasonic		
R13, R14	2	0.91	RES, 0.91, 1%, 0.25 W, 0805	0805	CRM0805-FX-R910ELF	Bourns		

Table 8-1. TPS23758EVM-080 BOM (continued)

Designator	Quantity	Value	Description	PackageReference	PartNumber	Manufacturer	Alternate PartNumber	Alternate Manufacturer
R15	1	0	RES, 1.0 K, 5%, 0.063 W, AEC-Q200 Grade 0, 0402	0402	CRCW04020000 Z0ED	Vishay-Dale		
R16	1	49.9	RES, 49.9, 1%, 0.063 W, 0402	0402	RC0402FR-0749 R9L	Yageo America		
R17	1	24.9 k	RES, 24.9 k, 1%, 0.063 W, AEC-Q200 Grade 0, 0402	0402	CRCW040224K9 FKED	Vishay-Dale		
R18	1	2.43 k	RES, 2.43 k, 1%, 0.1 W, AEC-Q200 Grade 0, 0603	0603	CRCW06032K43 FKEA	Vishay-Dale		
R19, R22	2	200 k	RES, 200 k, 1%, 0.1 W, 0402	0402	ERJ-2RKF2003X	Panasonic		
R21	1	200 k	RES, 200 k, 1%, 0.063 W, AEC-Q200 Grade 0, 0402	0402	CRCW0402200K FKED	Vishay-Dale		
R23	1	237 k	RES, 237 k, 1%, 0.063 W, AEC-Q200 Grade 0, 0402	0402	CRCW0402237K FKED	Vishay-Dale		
R24	1	36.5 k	RES, 36.5 k, 1%, 0.063 W, AEC-Q200 Grade 0, 0402	0402	CRCW040236K5 FKED	Vishay-Dale		
R25	1	100	RES, 100, 5%, 0.1 W, AEC-Q200 Grade 0, 0402	0402	ERJ-2GEJ101X	Panasonic		
R26	1	9.09 k	RES, 9.09 k, 5%, 0.063 W, AEC-Q200 Grade 0, 0402	0402	CRCW04029K09 FKED	Vishay-Dale		
R27	1	60.4 k	RES, 60.4 k, 1%, 0.063 W, AEC-Q200 Grade 0, 0402	0402	CRCW040260K4 FKED	Vishay-Dale		
R29	1	45.3	RES, 45.3, 1%, 0.1 W, AEC-Q200 Grade 0, 0603	0603	CRCW060345R3 FKEA	Vishay-Dale		
SH-J1, SH-J2	2		Shunt, 2.54 mm, Gold, Black	Shunt, 2.54 mm, Black	60900213421	Würth Elektronik		

Table 8-1. TPS23758EVM-080 BOM (continued)

Designator	Quantity	Value	Description	PackageReference	PartNumber	Manufacturer	Alternate PartNumber	Alternate Manufacturer
T1	1	350 uH	Transformer, 350 uH, SMT	358 x 236 x 500 mil	H2019FNLT	Pulse Engineering		
T2	1	150 uH	Transformer, 150 uH, SMT	14 x 16.2 mm	LDT1018-50R	Linkcom Manufacturing Co.	750318525	Wurth Elektronik
TP1	1		Test Point, Miniature, SMT	Test Point, Miniature, SMT	5019	Keystone		
TP2, TP3, TP4, TP5, TP8	5		Test Point, Miniature, Red, TH	Red Miniature Testpoint	5000	Keystone		
TP6, TP7, TP10, TP12	4		Test Point, Miniature, Black, TH	Black Miniature Testpoint	5001	Keystone		
TP9, TP13	2		Test Point, Miniature, Orange, TH	Orange Miniature Testpoint	5003	Keystone		
TP11	1		Test Point, Miniature, White, TH	White Miniature Testpoint	5002	Keystone		
U1	1		IEEE 802.3at PoE PD with No-Opto Flyback DC-DC Controller, RJJ0023B (VSON-23)	RJJ0023B	TPS23758RJJ	Texas Instruments		Texas Instruments
FID1, FID2, FID3, FID4, FID5, FID6	0		Fiducial mark. There is nothing to buy or mount.	N/A	N/A	N/A		
L3, L6	0	1 mH	Coupled inductor, 1 mH, 0.8 A, 0.31 ohm, SMD	9.2 x 6 mm	744222	Wurth Elektronik		

9 Revision History

NOTE: Page numbers for previous revisions may differ from page numbers in the current version.

Changes from Revision A (August 2019) to Revision B (December 2020)	Page
• Updated the numbering format for tables, figures and cross-references throughout the document.....	2
• Updated Schematic.....	4
• Updated Bill of Materials.....	16

IMPORTANT NOTICE AND DISCLAIMER

TI PROVIDES TECHNICAL AND RELIABILITY DATA (INCLUDING DATA SHEETS), DESIGN RESOURCES (INCLUDING REFERENCE DESIGNS), APPLICATION OR OTHER DESIGN ADVICE, WEB TOOLS, SAFETY INFORMATION, AND OTHER RESOURCES "AS IS" AND WITH ALL FAULTS, AND DISCLAIMS ALL WARRANTIES, EXPRESS AND IMPLIED, INCLUDING WITHOUT LIMITATION ANY IMPLIED WARRANTIES OF MERCHANTABILITY, FITNESS FOR A PARTICULAR PURPOSE OR NON-INFRINGEMENT OF THIRD PARTY INTELLECTUAL PROPERTY RIGHTS.

These resources are intended for skilled developers designing with TI products. You are solely responsible for (1) selecting the appropriate TI products for your application, (2) designing, validating and testing your application, and (3) ensuring your application meets applicable standards, and any other safety, security, regulatory or other requirements.

These resources are subject to change without notice. TI grants you permission to use these resources only for development of an application that uses the TI products described in the resource. Other reproduction and display of these resources is prohibited. No license is granted to any other TI intellectual property right or to any third party intellectual property right. TI disclaims responsibility for, and you will fully indemnify TI and its representatives against, any claims, damages, costs, losses, and liabilities arising out of your use of these resources.

TI's products are provided subject to [TI's Terms of Sale](#) or other applicable terms available either on ti.com or provided in conjunction with such TI products. TI's provision of these resources does not expand or otherwise alter TI's applicable warranties or warranty disclaimers for TI products.

TI objects to and rejects any additional or different terms you may have proposed.

Mailing Address: Texas Instruments, Post Office Box 655303, Dallas, Texas 75265
Copyright © 2022, Texas Instruments Incorporated