

3950X SERIES  
3.50mm HEADERS

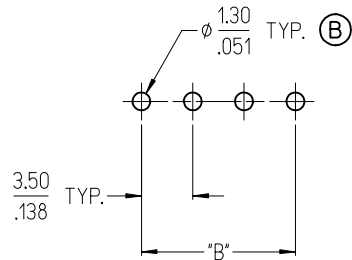

3952X & 3954X SERIES  
5.00mm HEADERS  
5.00mm FIXED

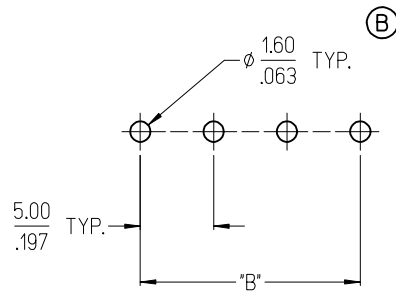

3953X SERIES  
5.08mm HEADERS

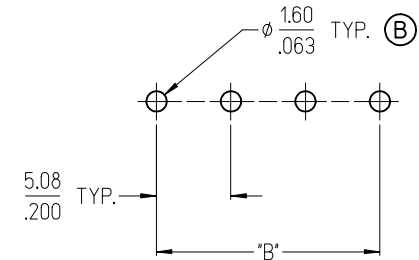

3951X SERIES  
3.81mm HEADERS

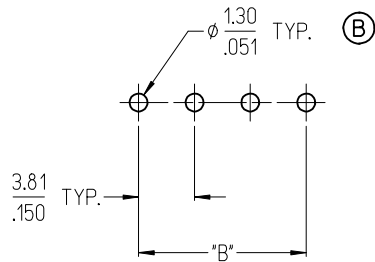

3954X SERIES  
5.00mm FIXED

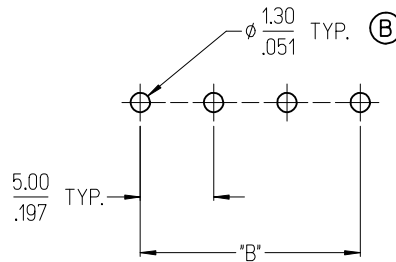

3954X SERIES  
5.08mm FIXED

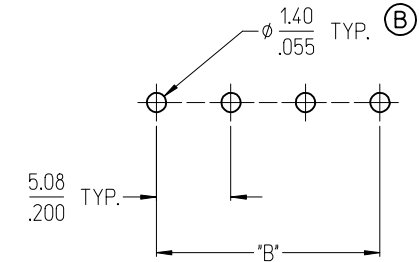

NOTES:

- REFER TO INDIVIDUAL PRODUCT SALES DRAWINGS FOR "B" DIMENSION.
- DOES NOT APPLY TO DUAL LEVEL HEADERS, SERIES 39528 AND 39538.
- TYP. = TYPICAL.

TOLERANCES			
MM	TOL	INCH	TOL
0-6	±0.25	0-.24	±.010
>6-30	±0.40	.24-1.18	±.016
>30-120	±0.50	1.18-4.76	±.020
>120	±0.80	>4.76	±.031

REVISED DOC TOL  
EC NO: IPG2017-0881  
DRAWN: VASUTHKARP 2017/03/23  
CHKD:  
APPR: BRUPERT 2017/04/18  
REV DESCRIPTION

QUALITY SYMBOLS  
▽=0  
▽=0

GENERAL TOLERANCES (UNLESS SPECIFIED)

	mm	INCH
4 PLACES	±---	±---
3 PLACES	±---	±---
2 PLACES	±---	±---
1 PLACE	±---	±---
ANGULAR ±---°		

DRAFT WHERE APPLICABLE  
MUST REMAIN  
WITHIN DIMENSIONS

DIMENSION STYLE  
MM/IN

DRAWN BY	DATE
C. YORK	2006/08/25
CHECKED BY	DATE
J. MACNEIL	2006/08/25
APPROVED BY	DATE
J. MACNEIL	2006/08/25

MATERIAL NO. --

SCALE DESIGN UNITS INCH

THIRD ANGLE PROJECTION

TITLE  
RECOMMENDED PCB LAYOUT FOR ESE TERMINAL BLOCKS

**molex** MOLEX INCORPORATED

DOCUMENT NO. SD-39501-002

SHEET NO. 1 OF 1

THIS DRAWING CONTAINS INFORMATION THAT IS PROPRIETARY TO MOLEX INCORPORATED AND SHOULD NOT BE USED WITHOUT WRITTEN PERMISSION

3950X SERIES  
3.50mm HEADERS

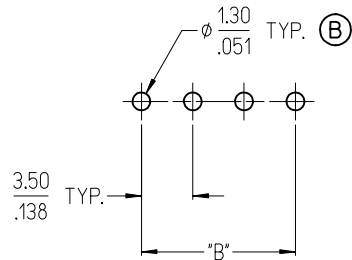

3952X & 3954X SERIES  
5.00mm HEADERS  
5.00mm FIXED

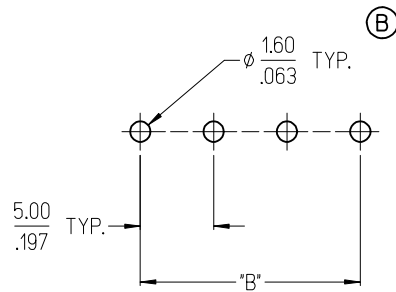

3953X SERIES  
5.08mm HEADERS

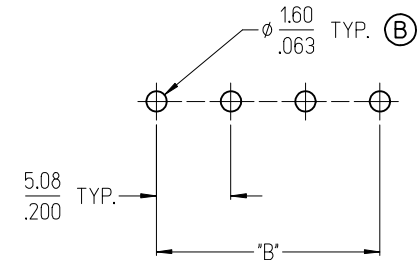

3951X SERIES  
3.81mm HEADERS

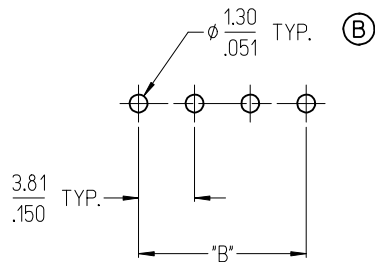

3954X SERIES  
5.00mm FIXED

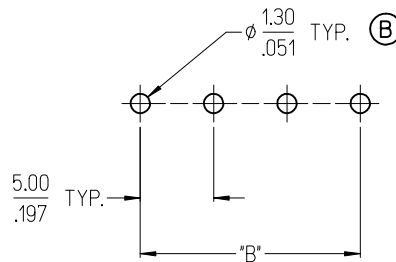

3954X SERIES  
5.08mm FIXED

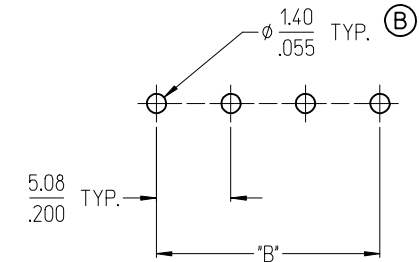

NOTES:

- REFER TO INDIVIDUAL PRODUCT SALES DRAWINGS FOR "B" DIMENSION.
- DOES NOT APPLY TO DUAL LEVEL HEADERS, SERIES 39528 AND 39538.
- TYP. = TYPICAL.

TOLERANCES			
MM	TOL	INCH	TOL
0-6	±0.25	0-.24	±.010
>6-30	±0.40	.24-1.18	±.016
>30-120	±0.50	1.18-4.76	±.020
>120	±0.80	>4.76	±.031

REVISED DOC TOL  
EC NO: IPG2017-0881  
DRAWN: VASUTHKARP 2017/03/23  
CHKD:  
APPR: BRUPERT 2017/04/18  
REV DESCRIPTION

QUALITY SYMBOLS  
▽=0  
▽=0

GENERAL TOLERANCES (UNLESS SPECIFIED)

	mm	INCH
4 PLACES	±---	±---
3 PLACES	±---	±---
2 PLACES	±---	±---
1 PLACE	±---	±---
ANGULAR ±---°		

DRAFT WHERE APPLICABLE  
MUST REMAIN  
WITHIN DIMENSIONS

DIMENSION STYLE  
MM/IN

DRAWN BY	DATE
C. YORK	2006/08/25
CHECKED BY	DATE
J. MACNEIL	2006/08/25
APPROVED BY	DATE
J. MACNEIL	2006/08/25

MATERIAL NO. --

SCALE DESIGN UNITS INCH

THIRD ANGLE PROJECTION

RECOMMENDED PCB LAYOUT FOR ESE TERMINAL BLOCKS

**molex** MOLEX INCORPORATED

DOCUMENT NO. SD-39501-002

SHEET NO. 1 OF 1

THIS DRAWING CONTAINS INFORMATION THAT IS PROPRIETARY TO MOLEX INCORPORATED AND SHOULD NOT BE USED WITHOUT WRITTEN PERMISSION

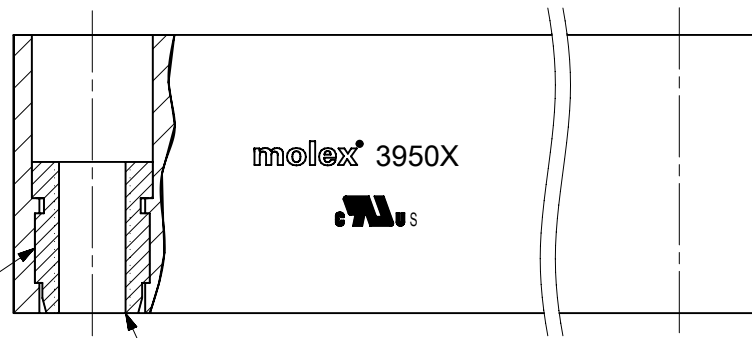

C  
SEE NOTES 3 & 4

M2.5 THREAD

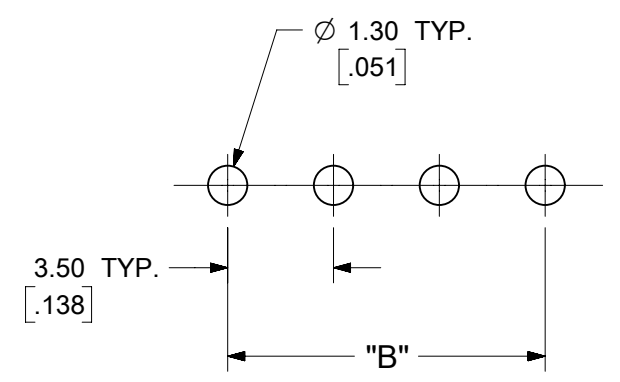
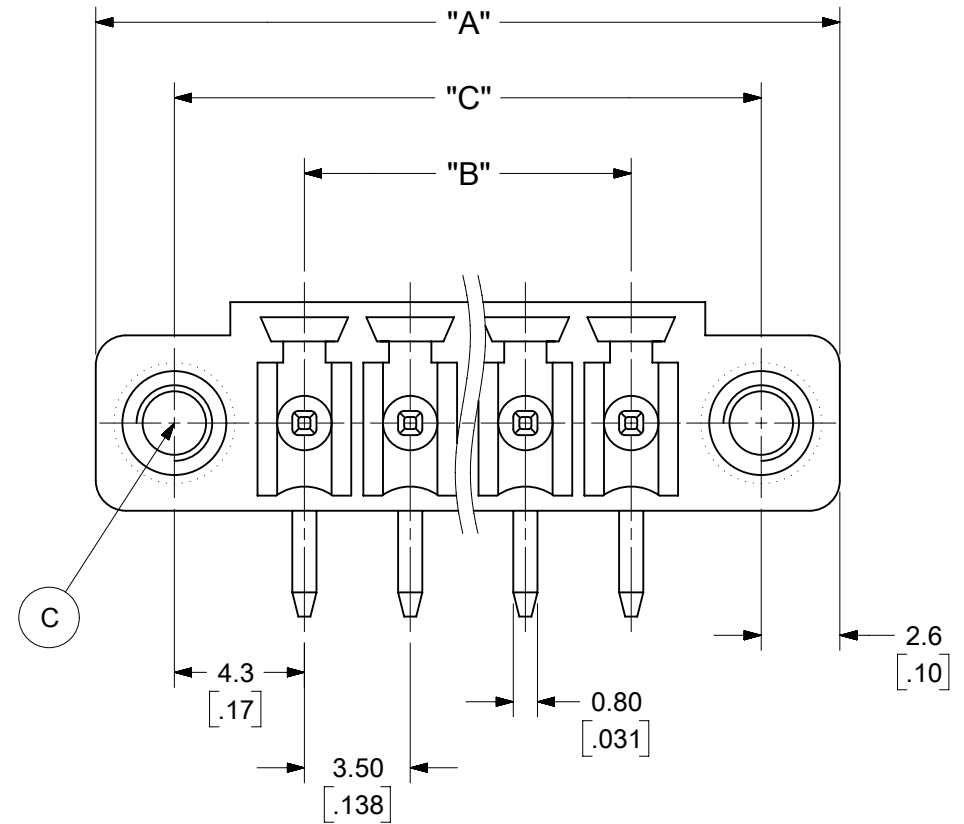
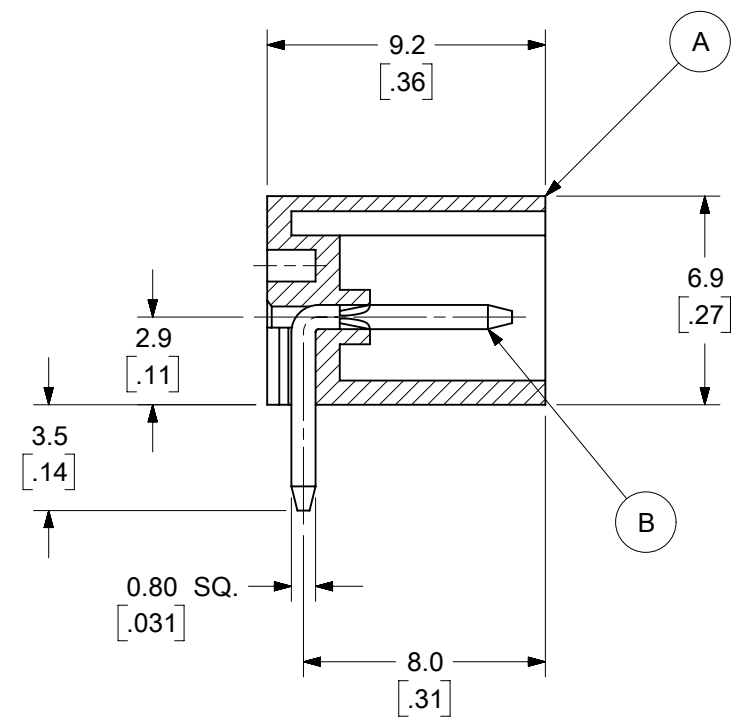

PCB LAYOUT

SPECIFICATIONS:

1. MATERIAL:
  - (A). BODY: PA66, UL 94V-0
  - (B). TERMINAL: BRASS - TIN PLATED
  - (C). THREADED INSERT: BRASS
2. ELECTRICAL RATING: 300V, 8A
3. MAX TORQUE: 1.59 in.lbs. (0.18NM)
4. MINIMUM INSERT RETENTION: 22 lbf (98N)
5. OPERATING TEMPERATURE: -40°C to +105°C
6. MAX. SOLDERING TEMP: 260°C (500°F) FOR 5 SECONDS
7. DIM A (OVERALL LENGTH)= (N x P) + 10.3mm
8. DIM B (CIRCUIT LENGTH)= (N - 1) x P
9. DIM C (MOUNTING HOLES)= (B + 8.6mm)
10. P (PITCH) = 3.50mm (.138")
11. N = NUMBER OF POSITIONS AVAILABLE 2 THROUGH 20
12. PRODUCT SPEC: PS-39500-001
13. SEE DRAWING SD-39501-002 FOR PTH INFO
14. DIMS. SHOWN ARE FOR REFERENCE ONLY.

TOLERANCES			
MM	TOL	INCH	TOL
0-6	±0.25	0-.24	±.010
>6-30	±0.40	.24-1.18	±.016
>30-120	±0.50	1.18-4.76	±.020
>120	±0.80	>4.76	±.031

<b>SYMBOLS</b> DIMENSION UNITS: MM/INCH SCALE: 4:1 GENERAL TOLERANCES (UNLESS SPECIFIED): 4 PLACES ± 3 PLACES ± 2 PLACES ± 1 PLACE ± 0 PLACES ± ANGULAR TOL ± ° DRAFT WHERE APPLICABLE MUST REMAIN WITHIN DIMENSIONS	THIS DRAWING CONTAINS INFORMATION THAT IS PROPRIETARY TO MOLEX ELECTRONIC TECHNOLOGIES, LLC AND SHOULD NOT BE USED WITHOUT WRITTEN PERMISSION		CURRENT REV DESC: MIGRATION TO ECTR/NX		<b>molex</b> 3.5MM, EURO HEADER RIGHT ANGLE, MOUNTING ENDS PRODUCT CUSTOMER DRAWING
	EC NO: 619929 DRWN: ABENJAMINLW 2019/06/12 CHK'D: DACHAMMER 2019/07/01 APPR: JFMURPHY 2019/07/08	INITIAL REVISION: DRWN: LROTHAUS 2006/01/09 APPR: JPAWLICK 2006/01/10	DOCUMENT NUMBER: SD-39506-001 DOC TYPE: PSD DOC PART: 001 REVISION: B2	MATERIAL NUMBER: SEE SHEET-2 CUSTOMER: GENERAL MARKET SHEET NUMBER: 1 OF 2	

DESCRIPTION	CIRCUIT SIZE	MATERIAL NUMBERS												DIMENSIONAL INFORMATION					
		BLACK						GREEN											
		100% TIN			30 u" GOLD			100% TIN			30 u" GOLD			DIM. "A"		DIM. "B"		DIM. "C"	
		PRINTING OPTIONS			PRINTING OPTIONS			PRINTING OPTIONS			PRINTING OPTIONS			mm	inch	mm	inch	mm	inch
		None	10AV	11AV	None	10AV	11AV	None	10AV	11AV	None	10AV	11AV						
3.5MM, EURO HEADER, RIGHT ANGLE, MOUNTING ENDS	2	395061002	395061102	395061202	395061502	395061602	395061702	395066002	395066102	395066202	395066502	395066602	395066702	17.30	.681	3.50	.138	12.10	.476
3.5MM, EURO HEADER, RIGHT ANGLE, MOUNTING ENDS	3	395061003	395061103	395061203	395061503	395061603	395061703	395066003	395066103	395066203	395066503	395066603	395066703	20.80	.819	7.00	.276	15.60	.614
3.5MM, EURO HEADER, RIGHT ANGLE, MOUNTING ENDS	4	395061004	395061104	395061204	395061504	395061604	395061704	395066004	395066104	395066204	395066504	395066604	395066704	24.30	.957	10.50	.413	19.10	.752
3.5MM, EURO HEADER, RIGHT ANGLE, MOUNTING ENDS	5	395061005	395061105	395061205	395061505	395061605	395061705	395066005	395066105	395066205	395066505	395066605	395066705	27.80	1.094	14.00	.551	22.60	.890
3.5MM, EURO HEADER, RIGHT ANGLE, MOUNTING ENDS	6	395061006	395061106	395061206	395061506	395061606	395061706	395066006	395066106	395066206	395066506	395066606	395066706	31.30	1.232	17.50	.689	26.10	1.028
3.5MM, EURO HEADER, RIGHT ANGLE, MOUNTING ENDS	7	395061007	395061107	395061207	395061507	395061607	395061707	395066007	395066107	395066207	395066507	395066607	395066707	34.80	1.370	21.00	.827	29.60	1.165
3.5MM, EURO HEADER, RIGHT ANGLE, MOUNTING ENDS	8	395061008	395061108	395061208	395061508	395061608	395061708	395066008	395066108	395066208	395066508	395066608	395066708	38.30	1.508	24.50	.965	33.10	1.303
3.5MM, EURO HEADER, RIGHT ANGLE, MOUNTING ENDS	9	395061009	395061109	395061209	395061509	395061609	395061709	395066009	395066109	395066209	395066509	395066609	395066709	41.80	1.646	28.00	1.102	36.60	1.441
3.5MM, EURO HEADER, RIGHT ANGLE, MOUNTING ENDS	10	395061010	395061110	395061210	395061510	395061610	395061710	395066010	395066110	395066210	395066510	395066610	395066710	45.30	1.783	31.50	1.240	40.10	1.579
3.5MM, EURO HEADER, RIGHT ANGLE, MOUNTING ENDS	11	395061011	395061111	395061211	395061511	395061611	395061711	395066011	395066111	395066211	395066511	395066611	395066711	48.80	1.921	35.00	1.378	43.60	1.717
3.5MM, EURO HEADER, RIGHT ANGLE, MOUNTING ENDS	12	395061012	395061112	395061212	395061512	395061612	395061712	395066012	395066112	395066212	395066512	395066612	395066712	52.30	2.059	38.50	1.516	47.10	1.854
3.5MM, EURO HEADER, RIGHT ANGLE, MOUNTING ENDS	13	395061013	395061113	395061213	395061513	395061613	395061713	395066013	395066113	395066213	395066513	395066613	395066713	55.80	2.197	42.00	1.654	50.60	1.992
3.5MM, EURO HEADER, RIGHT ANGLE, MOUNTING ENDS	14	395061014	395061114	395061214	395061514	395061614	395061714	395066014	395066114	395066214	395066514	395066614	395066714	59.30	2.335	45.50	1.791	54.10	2.130
3.5MM, EURO HEADER, RIGHT ANGLE, MOUNTING ENDS	15	395061015	395061115	395061215	395061515	395061615	395061715	395066015	395066115	395066215	395066515	395066615	395066715	62.80	2.472	49.00	1.929	57.60	2.268
3.5MM, EURO HEADER, RIGHT ANGLE, MOUNTING ENDS	16	395061016	395061116	395061216	395061516	395061616	395061716	395066016	395066116	395066216	395066516	395066616	395066716	66.30	2.610	52.50	2.067	61.10	2.406
3.5MM, EURO HEADER, RIGHT ANGLE, MOUNTING ENDS	17	395061017	395061117	395061217	395061517	395061617	395061717	395066017	395066117	395066217	395066517	395066617	395066717	69.80	2.748	56.00	2.205	64.60	2.543
3.5MM, EURO HEADER, RIGHT ANGLE, MOUNTING ENDS	18	395061018	395061118	395061218	395061518	395061618	395061718	395066018	395066118	395066218	395066518	395066618	395066718	73.30	2.886	59.50	2.343	68.10	2.681
3.5MM, EURO HEADER, RIGHT ANGLE, MOUNTING ENDS	19	395061019	395061119	395061219	395061519	395061619	395061719	395066019	395066119	395066219	395066519	395066619	395066719	76.80	3.024	63.00	2.480	71.60	2.819
3.5MM, EURO HEADER, RIGHT ANGLE, MOUNTING ENDS	20	395061020	395061120	395061220	395061520	395061620	395061720	395066020	395066120	395066220	395066520	395066620	395066720	80.30	3.161	66.50	2.618	75.10	2.957

TOLERANCES			
MM	TOL	INCH	TOL
0-6	±0.25	0-.24	±.010
>6-30	±0.40	.24-1.18	±.016
>30-120	±0.50	1.18-4.76	±.020
>120	±0.80	>4.76	±.031

SYMBOLS		THIS DRAWING CONTAINS INFORMATION THAT IS PROPRIETARY TO MOLEX ELECTRONIC TECHNOLOGIES, LLC AND SHOULD NOT BE USED WITHOUT WRITTEN PERMISSION	
▽ = 0	DIMENSION UNITS	SCALE	CURRENT REV DESC: MIGRATION TO ECTR/NX
▽ = 0	MM/INCH	2:1	
▽ = 0	GENERAL TOLERANCES (UNLESS SPECIFIED)		
▽ = 0	4 PLACES ±	MM	INCH
▽ = 0	3 PLACES ±	SEE CHART	SEE CHART
▽ = 0	2 PLACES ±	SEE CHART	SEE CHART
▽ = 0	1 PLACE ±	SEE CHART	SEE CHART
▽ = 0	0 PLACES ±	SEE CHART	SEE CHART
⊠ = 0	ANGULAR TOL ± °		
■ = 0	DRAFT WHERE APPLICABLE MUST REMAIN WITHIN DIMENSIONS		
▽ = 0	THIRD ANGLE PROJECTION	DRAWING	SERIES
		B-SIZE	39506
EC NO: 619929		DRWN: ABENJAMINLW	2019/06/12
DRWN: DACHAMMER		CHK'D: JFMURPHY	2019/07/01
APP: JFMURPHY		2019/07/08	
INITIAL REVISION:		DRWN: LROTHAUS	2006/01/09
		APP: JPAWLICK	2006/01/10
DOCUMENT NUMBER		DOC TYPE	DOC PART
SD-39506-001		PSD	001
REVISION		B2	
MATERIAL NUMBER		CUSTOMER	SHEET NUMBER
SEE TABLE		GENERAL MARKET	2 OF 2

Description	Circuit size	Material Numbers											Dimensional Information						
		Black						Green					Dim. A		Dim. B		Dim. C		
		100% Tin			30 u" Gold			100% Tin			30 u" Gold		mm	inch	mm	inch	mm	inch	
		Printing Options			Printing Options			Printing Options			Printing Options								
		None	10A	11A	None	10A	11A	None	10A	11A	None	10A	11A	mm	inch	mm	inch	mm	inch
3.5mm, Euro Header, Right Angle, Mounting Ends	2	395061002	395061102	395061202	395061502	395061602	395061702	395066002	395066102	395066202	395066502	395066602	395066702	17.30	0.681	3.50	0.138	12.10	0.476
3.5mm, Euro Header, Right Angle, Mounting Ends	3	395061003	395061103	395061203	395061503	395061603	395061703	395066003	395066103	395066203	395066503	395066603	395066703	20.80	0.819	7.00	0.276	15.60	0.614
3.5mm, Euro Header, Right Angle, Mounting Ends	4	395061004	395061104	395061204	395061504	395061604	395061704	395066004	395066104	395066204	395066504	395066604	395066704	24.30	0.957	10.50	0.413	19.10	0.752
3.5mm, Euro Header, Right Angle, Mounting Ends	5	395061005	395061105	395061205	395061505	395061605	395061705	395066005	395066105	395066205	395066505	395066605	395066705	27.80	1.094	14.00	0.551	22.60	0.890
3.5mm, Euro Header, Right Angle, Mounting Ends	6	395061006	395061106	395061206	395061506	395061606	395061706	395066006	395066106	395066206	395066506	395066606	395066706	31.30	1.232	17.50	0.689	26.10	1.028
3.5mm, Euro Header, Right Angle, Mounting Ends	7	395061007	395061107	395061207	395061507	395061607	395061707	395066007	395066107	395066207	395066507	395066607	395066707	34.80	1.370	21.00	0.827	29.80	1.165
3.5mm, Euro Header, Right Angle, Mounting Ends	8	395061008	395061108	395061208	395061508	395061608	395061708	395066008	395066108	395066208	395066508	395066608	395066708	38.30	1.508	24.50	0.965	33.10	1.303
3.5mm, Euro Header, Right Angle, Mounting Ends	9	395061009	395061109	395061209	395061509	395061609	395061709	395066009	395066109	395066209	395066509	395066609	395066709	41.80	1.646	28.00	1.102	36.60	1.441
3.5mm, Euro Header, Right Angle, Mounting Ends	10	395061010	395061110	395061210	395061510	395061610	395061710	395066010	395066110	395066210	395066510	395066610	395066710	45.30	1.793	31.50	1.240	40.10	1.579
3.5mm, Euro Header, Right Angle, Mounting Ends	11	395061011	395061111	395061211	395061511	395061611	395061711	395066011	395066111	395066211	395066511	395066611	395066711	48.80	1.921	35.00	1.379	43.60	1.717
3.5mm, Euro Header, Right Angle, Mounting Ends	12	395061012	395061112	395061212	395061512	395061612	395061712	395066012	395066112	395066212	395066512	395066612	395066712	52.30	2.059	38.50	1.516	47.10	1.854
3.5mm, Euro Header, Right Angle, Mounting Ends	13	395061013	395061113	395061213	395061513	395061613	395061713	395066013	395066113	395066213	395066513	395066613	395066713	55.80	2.197	42.00	1.654	50.80	1.992
3.5mm, Euro Header, Right Angle, Mounting Ends	14	395061014	395061114	395061214	395061514	395061614	395061714	395066014	395066114	395066214	395066514	395066614	395066714	59.30	2.335	45.50	1.791	54.10	2.130
3.5mm, Euro Header, Right Angle, Mounting Ends	15	395061015	395061115	395061215	395061515	395061615	395061715	395066015	395066115	395066215	395066515	395066615	395066715	62.80	2.472	49.00	1.929	57.80	2.268
3.5mm, Euro Header, Right Angle, Mounting Ends	16	395061016	395061116	395061216	395061516	395061616	395061716	395066016	395066116	395066216	395066516	395066616	395066716	66.30	2.610	52.50	2.067	61.10	2.406
3.5mm, Euro Header, Right Angle, Mounting Ends	17	395061017	395061117	395061217	395061517	395061617	395061717	395066017	395066117	395066217	395066517	395066617	395066717	69.80	2.749	56.00	2.205	64.80	2.543
3.5mm, Euro Header, Right Angle, Mounting Ends	18	395061018	395061118	395061218	395061518	395061618	395061718	395066018	395066118	395066218	395066518	395066618	395066718	73.30	2.886	59.50	2.343	68.10	2.681
3.5mm, Euro Header, Right Angle, Mounting Ends	19	395061019	395061119	395061219	395061519	395061619	395061719	395066019	395066119	395066219	395066519	395066619	395066719	76.80	3.024	63.00	2.480	71.60	2.819
3.5mm, Euro Header, Right Angle, Mounting Ends	20	395061020	395061120	395061220	395061520	395061620	395061720	395066020	395066120	395066220	395066520	395066620	395066720	80.30	3.161	66.50	2.618	75.10	2.957

TOLERANCES			
MM	TOL	INCH	TOL
0-6	±0.25	0-.24	±.010
>6-30	±0.40	.24-1.18	±.016
>30-120	±0.50	1.18-4.76	±.020
>120	±0.80	>4.76	±.031

REVISED DOC TOL EC NO: PG2017-0861 DRAWN: ANAGATH 2017/03/23 CHKD: APPR: BRUPERT 2017/04/18 REV	QUALITY SYMBOLS ▽=0 ▽=0	GENERAL TOLERANCES (UNLESS SPECIFIED) mm INCH 4 PLACES ± --- ± --- 3 PLACES ± --- ± --- 2 PLACES ± --- ± --- 1 PLACE ± --- ± --- ANGULAR ± ---°	DIMENSION STYLE MM/IN DRAWN BY DATE LROTHAUS 12/6/05 CHECKED BY DATE C. YORK 01/06/06 APPROVED BY DATE	SCALE DESIGN UNITS INCH THIRD ANGLE PROJECTION	
	DRAFT WHERE APPLICABLE MUST REMAIN WITHIN DIMENSIONS			TITLE 3.5MM, EURO HEADER RIGHT ANGLE, MOUNTING ENDS	
	MATERIAL NO. SEE CHART		MOLEX INCORPORATED		SHEET NO. 2 OF 2
	SIZE B		DOCUMENT NO. SD-39506-001 THIS DRAWING CONTAINS INFORMATION THAT IS PROPRIETARY TO MOLEX INCORPORATED AND SHOULD NOT BE USED WITHOUT WRITTEN PERMISSION		

Description	Circuit size	Material Numbers											Dimensional Information						
		Black						Green					Dim. A		Dim. B		Dim. C		
		100% Tin			30 u" Gold			100% Tin			30 u" Gold		mm	inch	mm	inch	mm	inch	
		Printing Options			Printing Options			Printing Options			Printing Options								
		None	10A	11A	None	10A	11A	None	10A	11A	None	10A	11A	mm	inch	mm	inch	mm	inch
3.5mm, Euro Header, Right Angle, Mounting Ends	2	395061002	395061102	395061202	395061502	395061602	395061702	395066002	395066102	395066202	395066502	395066602	395066702	17.30	0.681	3.50	0.138	12.10	0.476
3.5mm, Euro Header, Right Angle, Mounting Ends	3	395061003	395061103	395061203	395061503	395061603	395061703	395066003	395066103	395066203	395066503	395066603	395066703	20.80	0.819	7.00	0.276	15.60	0.614
3.5mm, Euro Header, Right Angle, Mounting Ends	4	395061004	395061104	395061204	395061504	395061604	395061704	395066004	395066104	395066204	395066504	395066604	395066704	24.30	0.957	10.50	0.413	19.10	0.752
3.5mm, Euro Header, Right Angle, Mounting Ends	5	395061005	395061105	395061205	395061505	395061605	395061705	395066005	395066105	395066205	395066505	395066605	395066705	27.90	1.094	14.00	0.551	22.60	0.890
3.5mm, Euro Header, Right Angle, Mounting Ends	6	395061006	395061106	395061206	395061506	395061606	395061706	395066006	395066106	395066206	395066506	395066606	395066706	31.30	1.232	17.50	0.689	26.10	1.028
3.5mm, Euro Header, Right Angle, Mounting Ends	7	395061007	395061107	395061207	395061507	395061607	395061707	395066007	395066107	395066207	395066507	395066607	395066707	34.80	1.370	21.00	0.827	29.80	1.165
3.5mm, Euro Header, Right Angle, Mounting Ends	8	395061008	395061108	395061208	395061508	395061608	395061708	395066008	395066108	395066208	395066508	395066608	395066708	38.30	1.508	24.50	0.965	33.10	1.303
3.5mm, Euro Header, Right Angle, Mounting Ends	9	395061009	395061109	395061209	395061509	395061609	395061709	395066009	395066109	395066209	395066509	395066609	395066709	41.80	1.646	28.00	1.102	36.60	1.441
3.5mm, Euro Header, Right Angle, Mounting Ends	10	395061010	395061110	395061210	395061510	395061610	395061710	395066010	395066110	395066210	395066510	395066610	395066710	45.30	1.793	31.50	1.240	40.10	1.579
3.5mm, Euro Header, Right Angle, Mounting Ends	11	395061011	395061111	395061211	395061511	395061611	395061711	395066011	395066111	395066211	395066511	395066611	395066711	48.90	1.921	35.00	1.379	43.60	1.717
3.5mm, Euro Header, Right Angle, Mounting Ends	12	395061012	395061112	395061212	395061512	395061612	395061712	395066012	395066112	395066212	395066512	395066612	395066712	52.30	2.059	38.50	1.516	47.10	1.854
3.5mm, Euro Header, Right Angle, Mounting Ends	13	395061013	395061113	395061213	395061513	395061613	395061713	395066013	395066113	395066213	395066513	395066613	395066713	55.80	2.197	42.00	1.654	50.80	1.992
3.5mm, Euro Header, Right Angle, Mounting Ends	14	395061014	395061114	395061214	395061514	395061614	395061714	395066014	395066114	395066214	395066514	395066614	395066714	59.30	2.335	45.50	1.791	54.10	2.130
3.5mm, Euro Header, Right Angle, Mounting Ends	15	395061015	395061115	395061215	395061515	395061615	395061715	395066015	395066115	395066215	395066515	395066615	395066715	62.80	2.472	49.00	1.929	57.80	2.268
3.5mm, Euro Header, Right Angle, Mounting Ends	16	395061016	395061116	395061216	395061516	395061616	395061716	395066016	395066116	395066216	395066516	395066616	395066716	66.30	2.610	52.50	2.067	61.10	2.406
3.5mm, Euro Header, Right Angle, Mounting Ends	17	395061017	395061117	395061217	395061517	395061617	395061717	395066017	395066117	395066217	395066517	395066617	395066717	69.90	2.749	56.00	2.205	64.80	2.543
3.5mm, Euro Header, Right Angle, Mounting Ends	18	395061018	395061118	395061218	395061518	395061618	395061718	395066018	395066118	395066218	395066518	395066618	395066718	73.30	2.896	59.50	2.343	68.10	2.661
3.5mm, Euro Header, Right Angle, Mounting Ends	19	395061019	395061119	395061219	395061519	395061619	395061719	395066019	395066119	395066219	395066519	395066619	395066719	76.80	3.024	63.00	2.480	71.60	2.819
3.5mm, Euro Header, Right Angle, Mounting Ends	20	395061020	395061120	395061220	395061520	395061620	395061720	395066020	395066120	395066220	395066520	395066620	395066720	80.30	3.161	66.50	2.618	75.10	2.957

TOLERANCES			
MM	TOL	INCH	TOL
0-6	±0.25	0-.24	±.010
>6-30	±0.40	.24-1.18	±.016
>30-120	±0.50	1.18-4.76	±.020
>120	±0.80	>4.76	±.031

<b>REVISED DOC TOL</b> EC NO: PG2017-0861 DRAWN: ANAGATH 2017/03/23 CHKD: APPR: BRUPERT 2017/04/18 REV	QUALITY SYMBOLS ▽=0 ▽=0	GENERAL TOLERANCES (UNLESS SPECIFIED) mm INCH 4 PLACES ± --- ± --- 3 PLACES ± --- ± --- 2 PLACES ± --- ± --- 1 PLACE ± --- ± --- ANGULAR ± ---°	DIMENSION STYLE MM/IN DRAWN BY DATE LROTHAUS 12/6/05 CHECKED BY DATE C. YORK 01/06/06 APPROVED BY DATE	SCALE DESIGN UNITS INCH THIRD ANGLE PROJECTION
	DRAFT WHERE APPLICABLE MUST REMAIN WITHIN DIMENSIONS		MATERIAL NO. SEE CHART	TITLE 3.5MM, EURO HEADER RIGHT ANGLE, MOUNTING ENDS MOLEX INCORPORATED
	SHEET NO. 2 OF 2		DOCUMENT NO. SD-39506-001	
	THIS DRAWING CONTAINS INFORMATION THAT IS PROPRIETARY TO MOLEX INCORPORATED AND SHOULD NOT BE USED WITHOUT WRITTEN PERMISSION			