

Ratings

Voltage: 600 V
 Temperature: -40~105 °C
 Flammability: FT2

Conductor

Conductor count: 2
 Gauge: 30 AWG 0.05 mm²
 Material: tinned copper strands
 Strand size: $\phi 0.1 \times 7$
 Resistance at 20 °C: 381 Ω /km max

Insulator

Material: mPPE
 Color: red, black
 Diameter: $\phi 0.8 \pm 0.08$ mm
 Average thickness: 0.23 mm
 Resistance at 20 °C: 100 M Ω /km min

Wrap

Material: cotton paper

Outer jacket

Material: mPPE, 85A
 Color: black
 Diameter: $\phi 3.2 \pm 0.15$ mm
 Average thickness: 0.75 mm

Wire marking: E339579 UL AWM STYLE 21509 30 AWG 105°C
 600V --- cUL AWM I A 105°C 600V FT2 TENSILITY

Bend radius

Minimum: 6 times diameter (19.2 mm)

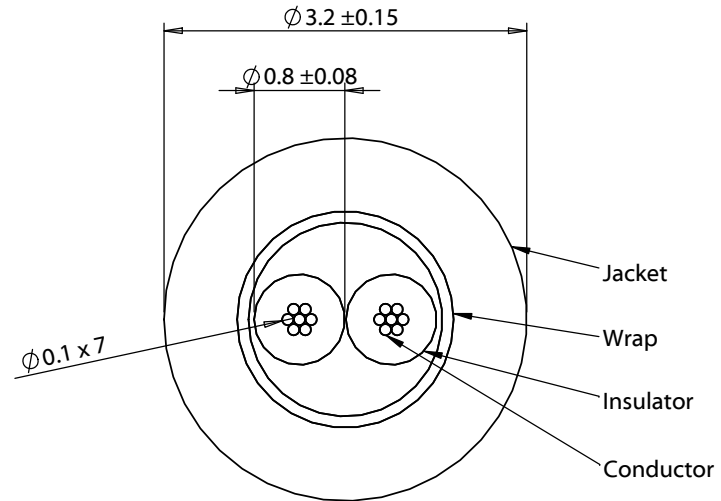
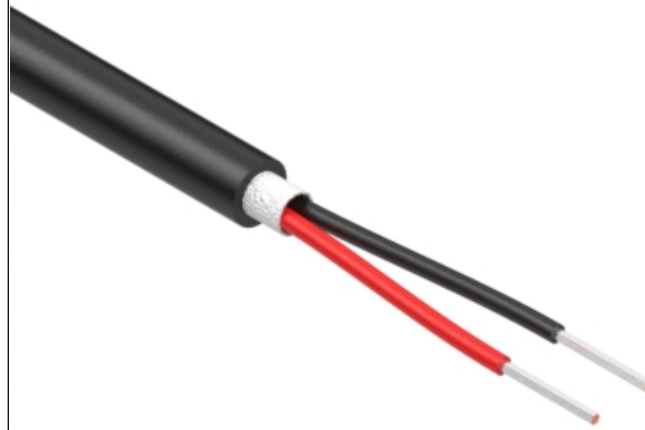

Revision:	Date:	Description:	Prepared:	Notes:	TENSILITY tel 1.541.323.3228 800 877.670.7118 fax 1.541.323.4202 web tensility.com
A	5/5/2021	Initial release	Verified:	RoHS compliant Phthalate and halogen free	
			Dimensions are in millimeters. Tolerances: X: ± 0.5 mm X.X: ± 0.3 mm X.XX: ± 0.05 mm	Description:	Size: Part number:
				Wire, 2C TS, 30 AWG, 21509, 600V, 105C, 3.2 mm, FT2, mPPE	A 30-01980
					Scale: 15:1

5

4

3

2

1