

Main Product Characteristics

BV_{DSS}	40V
$R_{DS(ON)}$	6.7m Ω
I_D	60A

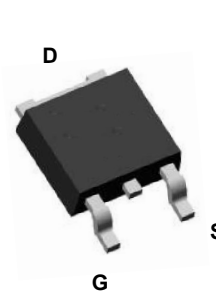

TO-252 (DPAK)

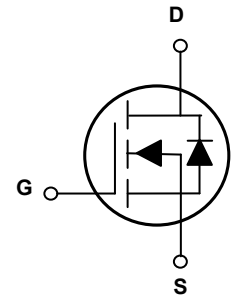

Schematic Diagram

Features and Benefits

- Advanced MOSFET process technology
- Ideal for high efficiency switched mode power supplies
- Low on-resistance with low gate charge
- Fast switching and reverse body recovery



Description

The GSFD0460 utilizes the latest techniques to achieve high cell density and low on-resistance. These features make this device extremely efficient and reliable for use in high efficiency switch mode power supply and a wide variety of other applications.

Absolute Maximum Ratings ($T_C=25^\circ\text{C}$ unless otherwise specified)

Parameter	Symbol	Max.	Unit
Drain-Source Voltage	V_{DS}	40	V
Gate-Source Voltage	V_{GS}	± 20	V
Drain Current-Continuous ($T_C=25^\circ\text{C}$)	I_D	60	A
Drain Current-Continuous ($T_C=100^\circ\text{C}$)		38	
Drain Current-Pulsed ¹	I_{DM}	240	A
Single Pulse Avalanche Energy ²	E_{AS}	76	mJ
Single Pulse Avalanche Current ²	I_{AS}	39	A
Power Dissipation ($T_C=25^\circ\text{C}$)	P_D	62	W
Power Dissipation-Derate above 25°C		0.496	
Thermal Resistance, Junction-to-Ambient	$R_{\theta JA}$	62	$^\circ\text{C}/\text{W}$
Thermal Resistance, Junction-to-Case	$R_{\theta JC}$	2.01	$^\circ\text{C}/\text{W}$
Operating Junction Temperature Range	T_J	-55 To +150	$^\circ\text{C}$
Storage Temperature Range	T_{STG}	-55 To +150	$^\circ\text{C}$

Electrical Characteristics ($T_J=25^{\circ}\text{C}$ unless otherwise specified)

Parameter	Symbol	Conditions	Min.	Typ.	Max.	Unit
On/Off Characteristics						
Drain-Source Breakdown Voltage	BV_{DSS}	$V_{GS}=0V, I_D=250\mu A$	40	-	-	V
BV_{DSS} Temperature Coefficient	$\Delta BV_{DSS}/\Delta T_J$	Reference to 25°C , $I_D=1mA$	-	0.03	-	$V/^{\circ}\text{C}$
Drain-Source Leakage Current	I_{DSS}	$V_{DS}=40V,$ $V_{GS}=0V, T_J=25^{\circ}\text{C}$	-	-	1	μA
		$V_{DS}=32V, V_{GS}=0V,$ $T_J=125^{\circ}\text{C}$	-	-	10	μA
Gate-Source Leakage Current	I_{GSS}	$V_{GS}=\pm 20V, V_{DS}=0V$	-	-	± 100	nA
Static Drain-Source On-Resistance ³	$R_{DS(ON)}$	$V_{GS}=10V, I_D=10A$	-	5.7	6.7	m Ω
		$V_{GS}=4.5V, I_D=5A$	-	7	8.8	
Gate Threshold Voltage	$V_{GS(th)}$	$V_{GS}=V_{DS}, I_D=250\mu A$	1.2	1.6	2.5	V
$V_{GS(th)}$ Temperature Coefficient	$\Delta V_{GS(th)}$		-	-5	-	mV/ $^{\circ}\text{C}$
Forward Transconductance	g_{fs}	$V_{DS}=10V, I_D=3A$	-	16	-	S
Dynamic and Switching Characteristics						
Total Gate Charge ^{3,4}	Q_g	$V_{DS}=20V, I_D=10A,$ $V_{GS}=4.5V$	-	16.2	32	nC
Gate-Source Charge ^{3,4}	Q_{gs}		-	3.85	7	
Gate-Drain Charge ^{3,4}	Q_{gd}		-	6.05	12	
Turn-On Delay Time ^{3,4}	$t_{d(on)}$	$V_{DD}=15V, R_G=6\Omega,$ $V_{GS}=10V, I_D=1A$	-	13.6	25	nS
Rise Time ^{3,4}	t_r		-	2.5	5	
Turn-Off Delay Time ^{3,4}	$t_{d(off)}$		-	68	120	
Fall Time ^{3,4}	t_f		-	5	10	
Input Capacitance	C_{iss}	$V_{DS}=25V, V_{GS}=0V,$ $F=1MHz$	-	1540	2500	pF
Output Capacitance	C_{oss}		-	171	330	
Reverse Transfer Capacitance	C_{rss}		-	115	220	
Gate Resistance	R_g	$V_{GS}=0V, V_{DS}=0V,$ $F=1MHz$	-	1.2	2.2	Ω
Drain-Source Diode Characteristics and Maximum Ratings						
Continuous Source Current	I_S	$V_G=V_D=0V,$ Force Current	-	-	60	A
Pulsed Source Current ³	I_{SM}		-	-	120	A
Diode Forward Voltage ³	V_{SD}	$V_{GS}=0V,$ $I_S=1A, T_J=25^{\circ}\text{C}$	-	-	1	V

Note:

F \dot{E} Repetitive rating: Pulsed width limited by maximum junction temperature.

G \dot{E} $V_{DD}=25V, V_{GS}=10V, L=0.1mH, I_{AS}=39A,$ starting $T_J=25^{\circ}\text{C}$.

H \dot{E} Pulse test: pulse width $\leq 300\mu s,$ duty cycle $\leq 2\%$.

I \dot{E} Essentially independent of operation temperature.

Typical Electrical and Thermal Characteristic Curves

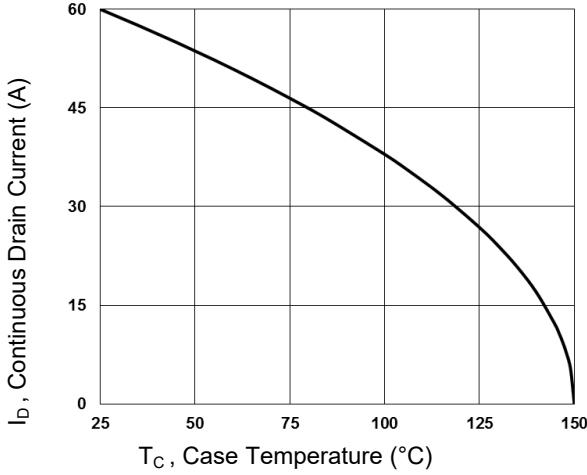

Figure 1. Continuous Drain Current vs. T_c

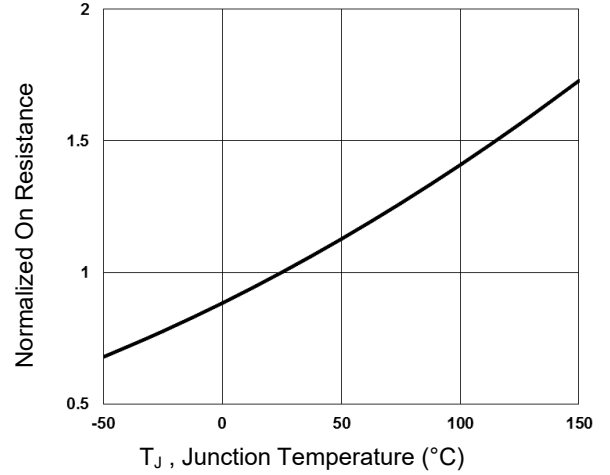

Figure 2. Normalized R_{DSON} vs. T_j

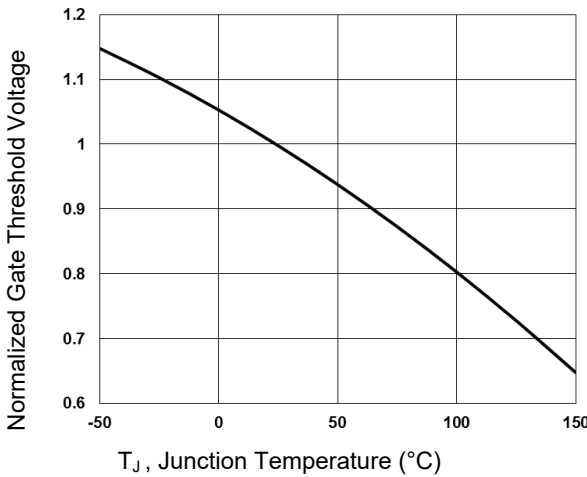

Figure 3. Normalized V_{th} vs. T_j

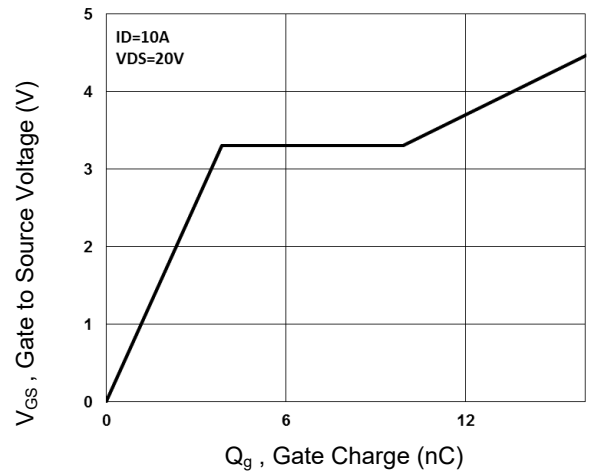

Figure 4. Gate Charge Waveform

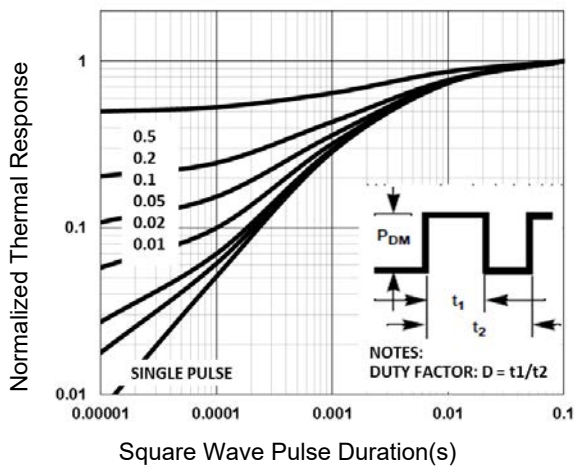

Figure 5. Normalized Transient Impedance

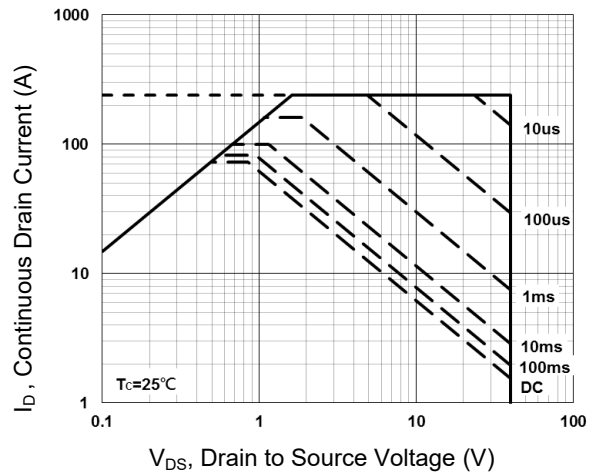

Figure 6. Maximum Safe Operation Area

Typical Electrical and Thermal Characteristic Curves

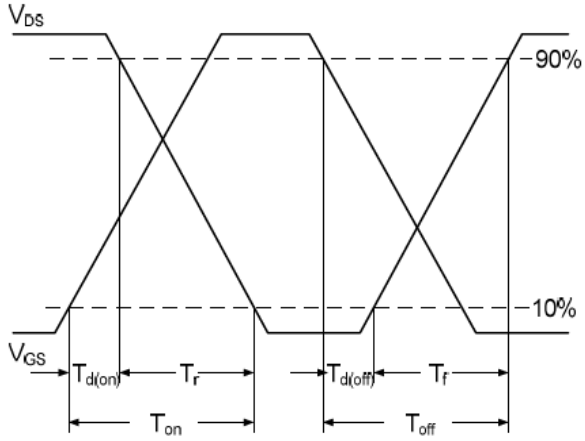

Figure 7. Switching Time Waveform

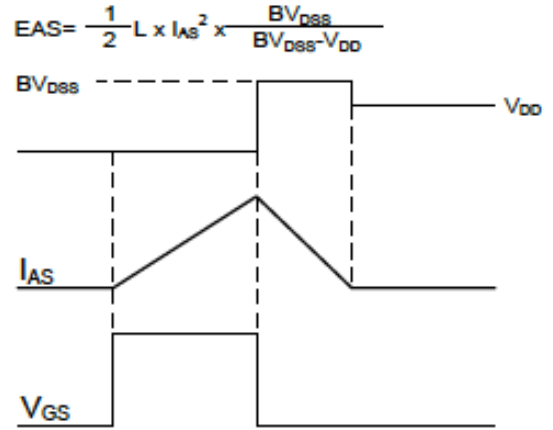
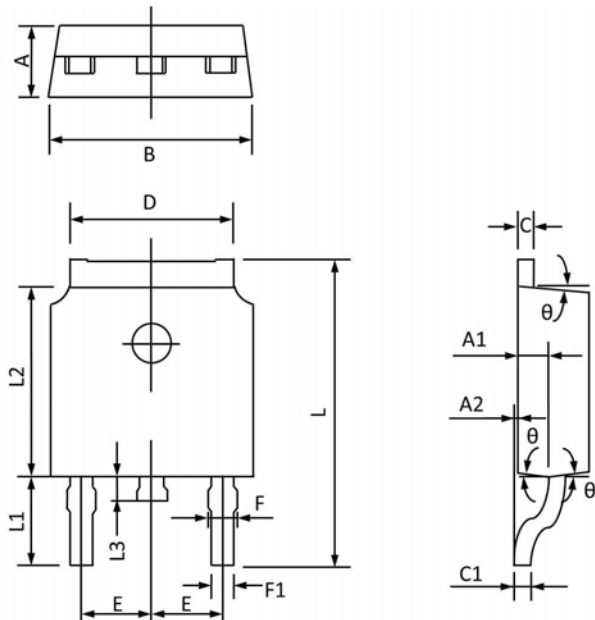

Figure 8. EAS Waveform

Package Outline Dimensions (TO-252)



Symbol	Dimensions In Millimeters		Dimensions In Inches	
	MAX	MIN	MAX	MIN
A	2.400	2.200	0.094	0.087
A1	1.110	0.910	0.044	0.036
A2	0.150	0.000	0.006	0.000
B	6.800	6.400	0.268	0.252
C	0.580	0.450	0.023	0.018
C1	0.580	0.460	0.023	0.018
D	5.500	5.100	0.217	0.201
E	2.386	2.186	0.094	0.086
F	0.940	0.600	0.037	0.024
F1	0.860	0.500	0.034	0.020
L	10.400	9.400	0.409	0.370
L1	3.000	2.400	0.118	0.094
L2	6.200	5.400	0.244	0.213
L3	1.200	0.600	0.047	0.024
θ	9°	3°	9°	3°