

High Speed and High Accuracy Programmable Power Supply Series IT6100B User's Manual

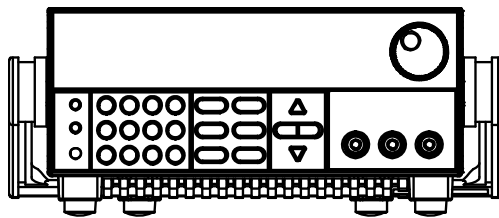

Model: IT6121B/IT6122B/IT6123B/IT6132B/
IT6133B/IT6162B/IT6164B
Version: V1.1

Notices

© Itech Electronic, Co., Ltd. 2018
No part of this manual may be reproduced in any form or by any means (including electronic storage and retrieval or translation into a foreign language) without prior permission and written consent from Itech Electronic, Co., Ltd. as governed by international copyright laws.

Manual Part Number

IT6100B-402198

Revision

1st Edition: Apr. 8, 2018
Itech Electronic, Co., Ltd.

Trademarks

Pentium is U.S. registered trademarks of Intel Corporation.

Microsoft, Visual Studio, Windows and MS Windows are registered trademarks of Microsoft Corporation in the United States and/or other countries and regions.

Warranty

The materials contained in this document are provided “as is”, and is subject to change, without prior notice, in future editions. Further, to the maximum extent permitted by applicable laws, ITECH disclaims all warranties, either express or implied, with regard to this manual and any information contained herein, including but not limited to the implied warranties of merchantability and fitness for a particular purpose. ITECH shall not be held liable for errors or for incidental or indirect damages in connection with the furnishing, use or application of this document or of any information contained herein. Should ITECH and the user enter into a separate written agreement with warranty terms covering the materials in this document that conflict with these terms, the warranty terms in the separate agreement shall prevail.

Technology Licenses

The hardware and/or software described herein are furnished under a license and may be used or copied only in accordance with the terms of such license.

Restricted Rights Legend

Restricted permissions of the U.S. government. Permissions for software and technical data which are authorized to the U.S. Government only include those for custom provision to end users ITECH provides this customary commercial license in software and technical data pursuant to FAR 12.211 (Technical Data) and 12.212 (Computer Software) and, for the Department of Defense, DFARS 252.227-7015 (Technical Data – Commercial Items) and DFARS 227.7202-3 (Rights in Commercial Computer Software or Computer Software Documentation).

Safety Notices

CAUTION

A CAUTION sign denotes a hazard. It calls attention to an operating procedure or practice that, if not correctly performed or adhered to, could result in damage to the product or loss of important data. Do not proceed beyond a CAUTION sign until the indicated conditions are fully understood and met.

WARNING

A WARNING sign denotes a hazard. It calls attention to an operating procedure or practice that, if not correctly performed or adhered to, could result in personal injury or death. Do not proceed beyond a WARNING sign until the indicated conditions are fully understood and met.



NOTE

A NOTE sign denotes important hint. It calls attention to tips or supplementary information that is essential for users to refer to.

Quality Certification and Assurance

We certify that IT6100B series power supply meets all the published specifications.

Warranty

ITECH warrants that the product will be free from defects in material and workmanship under normal use for a period of one (1) year from the date of delivery (except those described in the Limitation of Warranty below).

For warranty service or repair, the product must be returned to a service center designated by ITECH.















- The product returned to ITECH for warranty service must be shipped PREPAID. And ITECH will pay for return of the product to customer.
- If the product is returned to ITECH for warranty service from overseas, all the freights, duties and other taxes shall be on the account of customer.

Limitation of Warranty

This Warranty will be rendered invalid if the product is:

- Damage caused by circuit installed by customer or using customer own products or accessories;
- Modified or repaired by customer without authorization;
- Damage caused by circuit installed by customer or not operating our products under designated environment;
- The product model or serial number is modified, deleted, removed or illegible;
- Damaged as a result of accidents, including but not limited to lightning, moisture, fire, improper use or negligence.

Safety Symbols

	Direct current		ON (power on)
	Alternating current		OFF (power off)
	Both direct and alternating current		Power-on state
	Protective conductor terminal		Power-off state
	Earth (ground) terminal		Reference terminal
	Caution, risk of electric shock		Positive terminal
	Warning, risk of danger (refer to this manual for specific Warning or Caution information)		Negative terminal
	Frame or chassis terminal	-	-

Safety Precautions

The following safety precautions must be observed during all phases of operation of this instrument. Failure to comply with these precautions or specific warnings elsewhere in this manual will constitute a default under safety standards of design, manufacture and intended use of the instrument. ITECH assumes no liability for the customer's failure to comply with these precautions.

WARNING

- Do not use the instrument if it is damaged. Before operation, check the casing to see whether it cracks. Do not operate the instrument in the presence of inflammable gasses, vapors or dusts.
- The power supply is provided with a three-core power line during delivery and should be connected to a three-core junction box. Before operation, be sure that the power supply is well grounded. Make sure to use the power cord supplied by ITECH.
- Check all marks on the instrument before connecting the instrument to power supply.
- Use electric wires of appropriate load. All loading wires should be capable of bearing maximum short-circuit of electronic load without overheating. If there are multiple loads, each pair of the load power cord must be carry out the full rated short-circuit output current of the power securely.
- Ensure the voltage fluctuation of mains supply is less than 10% of the working voltage range in order to reduce risks of fire and electric shock.
- Do not install alternative parts on the instrument or perform any unauthorized modification.
- Do not use the instrument if the detachable cover is removed or loosen.
- To prevent the possibility of accidental injuries, be sure to use the power adapter supplied by the manufacturer only.
- We do not accept responsibility for any direct or indirect financial damage or loss of profit that might occur when using the instrument.
- This instrument is used for industrial purposes, do not apply this product to IT power supply system.
- Never use the instrument with a life-support system or any other equipment subject to safety requirements.

CAUTION

- Failure to use the instrument as directed by the manufacturer may render its protective features void.
- Always clean the casing with a dry cloth. Do not clean the internals.
- Make sure the vent hole is always unblocked.

Environmental Conditions



The instrument is designed for indoor use and an area with low condensation. The table below shows the general environmental requirements for the instrument. The speed of fan will change intelligently by the temperature of radiator. When the temperature is up to 40°C, the fan will be on and adjust intelligently when temperature changes.

Environmental Conditions	Requirements
Operating temperature	0°C to 40°C
Operating humidity	20%-80% (non-condensation)
Storage temperature	-20°C to 70 °C
Altitude	≤2,000m
Pollution degree	Pollution degree 2
Installation category	II

NOTE

To make accurate measurements, allow the instrument to warm up for 30 min before operation.

Regulatory Markings

	<p>The CE mark is a registered trademark of the European Community. This CE mark shows that the product complies with all the relevant European Legal Directives.</p>
	<p>The instrument complies with the WEEE Directive (2002/96/EC) marking requirement. This affixed product label indicates that you must not discard the electrical/electronic product in domestic household waste.</p>
	<p>This symbol indicates the time period during which no hazardous or toxic substances are expected to leak or deteriorate during normal use. The expected service life of the product is 10 years. The product can be used safely during the 10-year Environment Friendly Use Period (EFUP). Upon expiration of the EFUP, the product must be immediately recycled.</p>

Waste Electrical and Electronic Equipment (WEEE) Directive



2002/96/EC Waste Electrical and Electronic Equipment (WEEE) Directive

This product complies with the WEEE Directive (2002/96/EC) marking requirement. This affix product label indicates that you must not discard the electrical/electronic product in domestic household waste.

Product Category

With reference to the equipment classifications described in the Annex I of the WEEE Directive, this instrument is classified as a "Monitoring and Control Instrument" product.

To return this unwanted instrument, contact your nearest ITECH office.

Compliance Information

Complies with the essential requirements of the following applicable European Directives, and carries the CE marking accordingly:

- Electromagnetic Compatibility (EMC) Directive 2014/30/EU
- Low-Voltage Directive (Safety) 2014/35/EU

Conforms with the following product standards:

EMC Standard

IEC 61326-1:2012/ EN 61326-1:2013 ¹²³

Reference Standards

CISPR 11:2009+A1:2010/ EN 55011:2009+A1:2010 (Group 1, Class A)

IEC 61000-4-2:2008/ EN 61000-4-2:2009

IEC 61000-4-3:2006+A1:2007+A2:2010/ EN 61000-4-3:2006+A1:2008+A2:2010

IEC 61000-4-4:2004+A1:2010/ EN 61000-4-4:2004+A1:2010

IEC 61000-4-5:2005/ EN 61000-4-5:2006

IEC 61000-4-6:2008/ EN 61000-4-6:2009

IEC 61000-4-11:2004/ EN 61000-4-11:2004

1. The product is intended for use in non-residential/non-domestic environments. Use of the product in residential/domestic environments may cause electromagnetic interference.
2. Connection of the instrument to a test object may produce radiations beyond the specified limit.
3. Use high-performance shielded interface cable to ensure conformity with the EMC standards listed above.

Safety Standard

IEC 61010-1:2010/ EN 61010-1:2010

CONTENTS

Quality Certification and Assurance.....	i
Warranty.....	i
Limitation of Warranty.....	i
Safety Symbols.....	i
Safety Precautions.....	ii
Environmental Conditions.....	ii
Regulatory Markings.....	iii
Waste Electrical and Electronic Equipment (WEEE) Directive.....	iii
Compliance Information.....	iv
Chapter1 Inspection and Installation.....	1
1.1 Verifying the Shipment.....	1
1.2 Instrument Size Introduction.....	1
1.3 Rack Mounting.....	4
1.4 Connecting the Power Cord.....	4
1.5 Connecting Test Lines (Optional).....	5
Chapter2 Quick Reference.....	8
2.1 Brief Introduction.....	8
2.2 Front Panel Introduction.....	9
2.3 Rear Panel Introduction.....	10
2.4 Keyboard Introduction.....	12
2.5 Function description of VFD status indicators.....	13
2.6 Power-on self-test.....	13
Chapter3 Basic operation.....	16
3.1 Local/Remote Mode.....	16
3.2 Setting the Voltage.....	16
3.3 Setting the Current.....	17
3.4 On/Off Operation.....	17
3.5 Set mode and Meter mode.....	18
3.6 CC and CV.....	18
3.7 Save and recall operation.....	18
3.8 Trigger operation.....	19
3.9 Menu Operation.....	19
3.10 OVP.....	27
3.11 Key Lock.....	27
3.12 Terminals at rear panel.....	27
3.13 Power information.....	31
Chapter4 Specification.....	32
4.1 Specification.....	32
Chapter5 Remote Operation Mode.....	36
5.1 RS232 interface.....	36
5.2 USB interface.....	37
5.3 GPIB interface (Only for IT6100B(G) series).....	38
5.4 Communication protocol.....	38
Appendix.....	39
Specifications of Red and Black Test Lines.....	39

Chapter1 Inspection and Installation

1.1 Verifying the Shipment

Unpack the box and check the contents before operating the instrument. If wrong items have been delivered, if items are missing, or if there is a defect with the appearance of the items, contact the dealer from which you purchased the instrument immediately. The package contents include:

Checklist of Package Contents

Item	Qty.	Model	Remarks
IT6100B power supply	x1	IT6100B series	The IT6100B series include: IT6121B/IT6122B/IT6123B/IT6132B/IT6133B/IT6162B/IT6164B
Power cord	x1	IT-E171/IT-E172/IT-E173/IT-E174	User may select an appropriate power cord that matches the specifications of power socket used in the area. See the Section Connecting the Power Cord for details.
USB cable	x1	-	-
Ex-factory Test Report	x1	-	It is the test report of the instrument before delivery.



NOTE

After confirming that package contents are consistent and correct, please appropriately keep package box and related contents. The package requirements should be met when the instrument is returned to factory for repair.

1.2 Instrument Size Introduction

The instrument should be installed at well-ventilated and rational-sized space. Please select appropriate space for installation based on the electronic load size.

IT6100B series power supply different models are not the same size; the detail size of the power supply is shown as below.

IT6121B/IT6122B/IT6123B/IT6132B/IT6133B Models

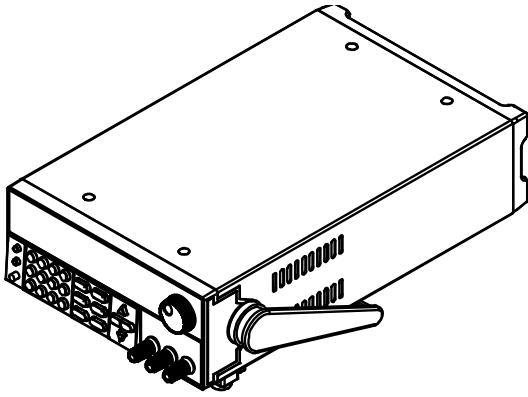

Detailed Dimension Drawing

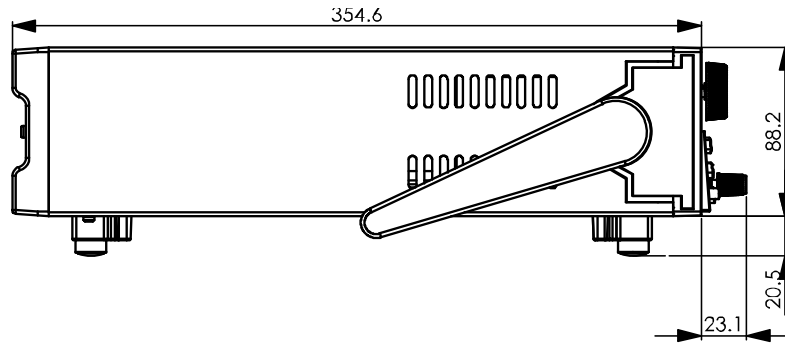
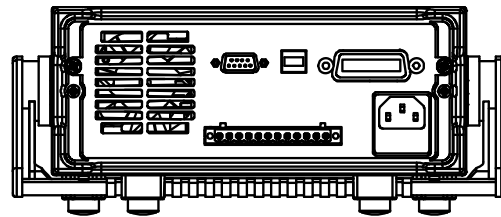
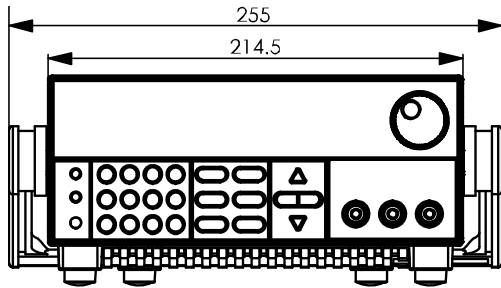

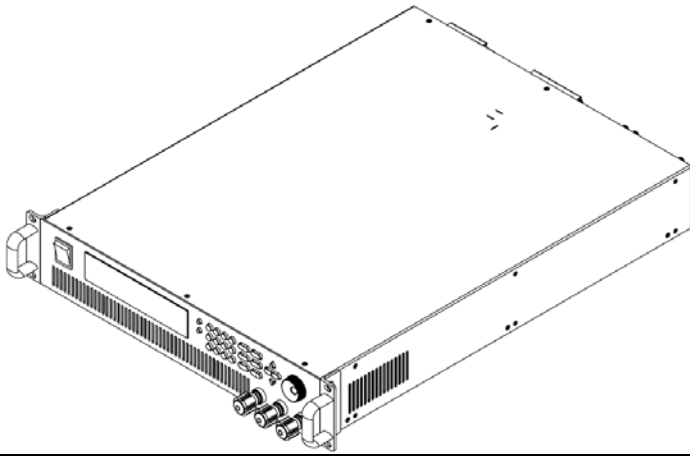

Detailed Dimension Drawing

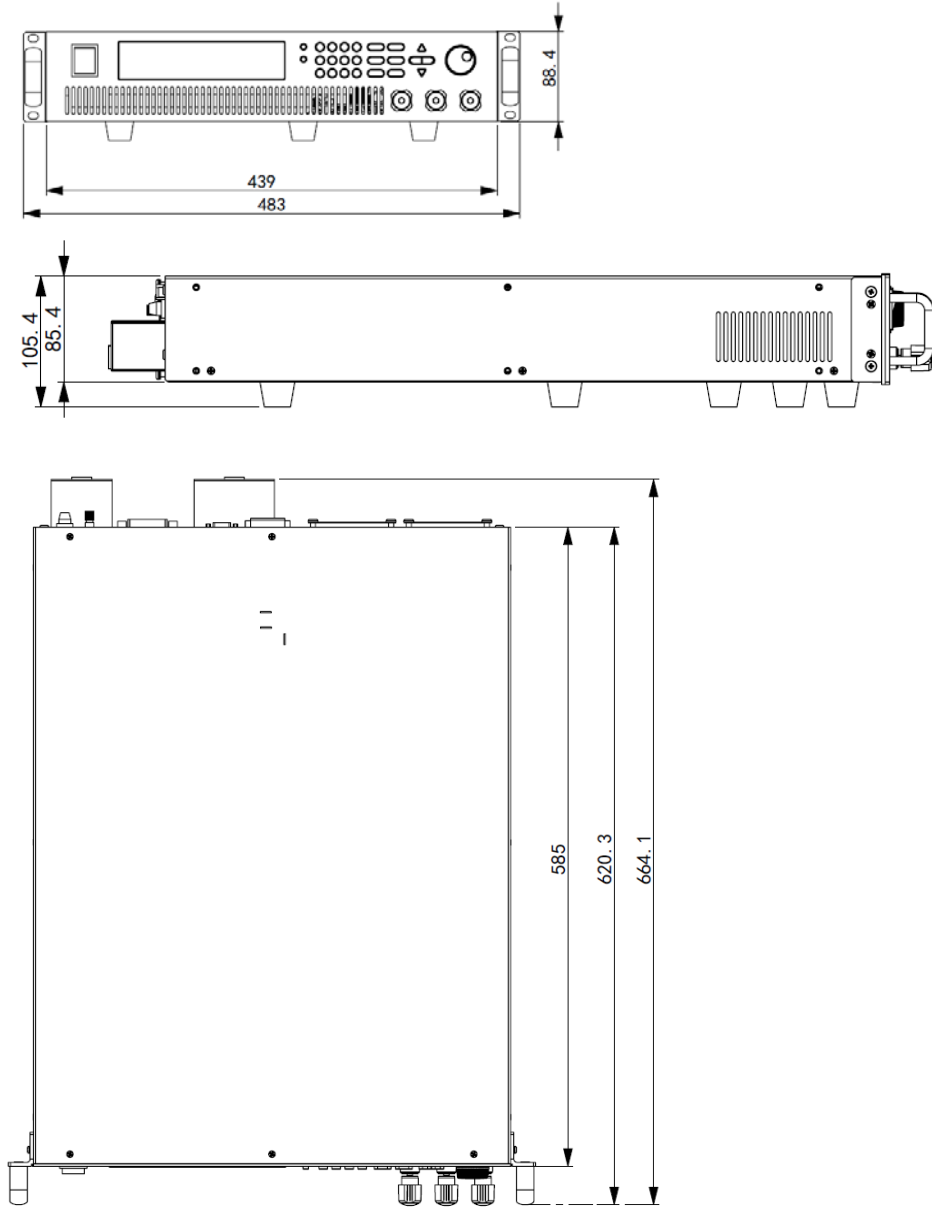

1.3 Rack Mounting

IT6100B series can be mounted on a standard rack. ITECH provides user with IT-E151 or IT-E151A rack, as a mount kit. The detailed operation please refer to the User Manual of your mount kit.

1.4 Connecting the Power Cord

Connect power cord of standard accessories and ensure that the power supply is under normal power supply.

AC power input level

Working voltage for IT6121B/IT6122B/IT6123B/IT6132B/IT6133B/IT6162B is 110V and 220V; Working voltage for IT6164B is 220V, so please pay attention to the working input voltage.

AC power input level:

- Option Opt.01: 220VAC \pm 10%, 47 to 63 Hz
- Option Opt.02: 110 VAC \pm 10%, 47 to 63 Hz

Categories of power cords

- IT6121B/IT6122B/IT6123B/IT6132B/IT6133B provides the standard power cords as below.

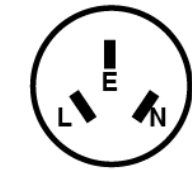

China
IT-171



America, Canada,
Japan
IT-E172

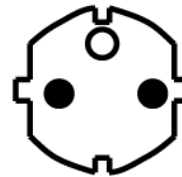

Europe
IT-E173



Britain
IT-E174

- IT6162B/IT6164B provides the standard power cords as below.

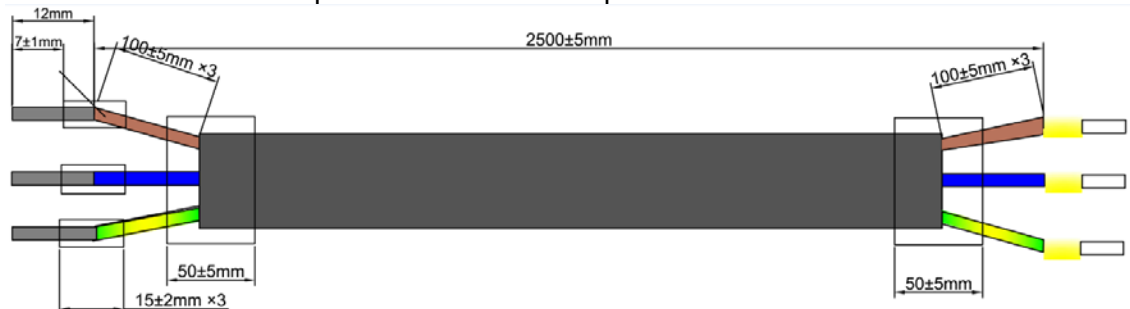

WARNING

The power cords supplied with this product is certified for safety. In case the supplied lines assembly needs to be replaced, or an extension lines must be added, be sure that it can meet the required power ratings of this product. Any misuse voids the warranty of this product.

Connecting AC Input

- IT6121B/IT6122B/IT6123B/IT6132B/IT6133B Connect standard power cord to the power supply input terminal.
- IT6162B/IT6164B AC input connector as follows.

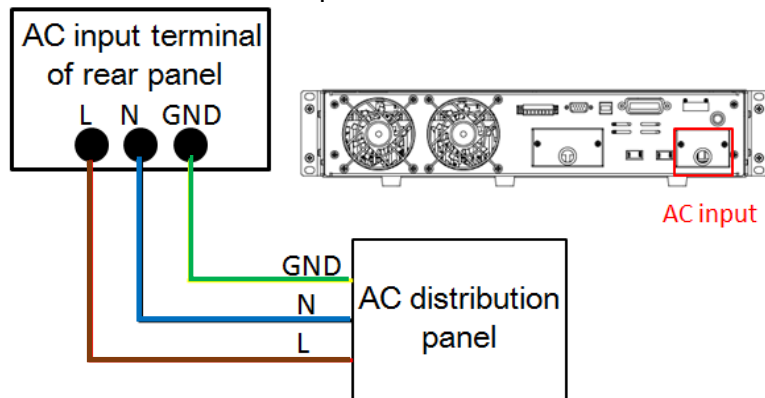

1. In the above illustration, one end of the AC power cord is connected to the AC input terminal in the rear panel of the power supply.
Connect the wire, zero line and ground to the corresponding terminal of the device. Before inserting, please loose the screw, lock the screw when it is inserted.
2. Connect the three terminals brown to line (L), blue to neutral (N), and yellow-green to ground (G) on the other end of the power cord to your AC distribution panel.

1.5 Connecting Test Lines (Optional)

Test lines are not standard accessories of the instrument. Please select optional red and black test lines for individual sales based on the maximum current value. For specifications of test lines and maximum current values, refer to "Specifications of Red and Black Test Lines" in "Appendix".

WARNING

- **Before connecting test lines, be sure to switch off the instrument. Power switch is in Off position. Otherwise, contact with output terminals in rear panel may cause electrical shock.**
- **To avoid electrical shock, before testing, please make sure the rating values of the testing lines, and do not measure the current that higher than the rating value. All test lines shall be capable of withstanding the maximum short circuit output current of the power supply without**

causing overheat.

- If several loads are provided, each pair of load wires shall safely withstand the rated short circuit output current of the power supply under full load.
- Always use test lines provided by ITECH to connect the equipment. If test lines from other factories are used, please check that the test line can withstand maximum current.
- During wiring, check that the anode and cathode of the test lines are properly and tightly connected; anode ON and cathode OFF are prohibited.

Introduction of Binding Posts

The maximum rated current of the terminal at position (A) is the maximum rated output current of the instrument. Securely fasten all wires by hand-tightening the binding posts. You can also insert standard banana plugs into the front of the connectors as shown in (B), and the maximum rated current at (B) is 10 A.

- IT6121B/IT6122B/IT6123B/IT6132B/IT6133B

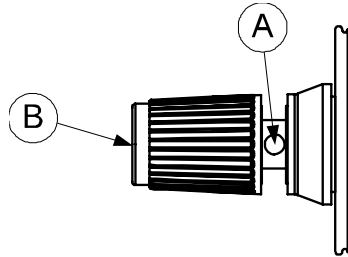

- IT6162B/IT6164B

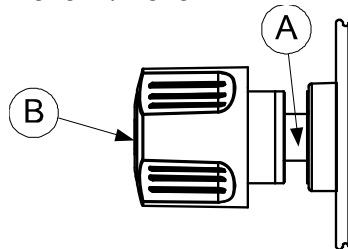

Connecting the DUT

Test line connection is given below taking local measurement as example. For details of local and remote measurements, refer to “**Terminals at rear panel**”.

1. Before connecting the test lines, be sure that the instrument Power is in Off position.
2. Check whether the shorting clip of Sense terminal is correctly mounted.
3. Unscrew the screws of the output terminals and connect the red and black test lines to the output terminals. Re-tighten the screws.

When maximum current that one test line can withstand fails to meet the current rated current, use several pieces of red and black test lines. For example, the maximum current is 1,200A, then 4 pieces of 360A red and black lines are required.

4. Directly connect the other end of the red and black lines to the DUT terminal.

Chapter2 Quick Reference

2.1 Brief Introduction

IT6100B Series power supplies are high resolution and high speed programmable DC power supplies. The Series power supplier has fast voltage rise speed and very high accuracy and resolution. Also configure with standard RS232/ USB interface to realize fast communication speed. The Series power supplier has remote sense function to compensate line voltage loss from power to determinand. List configure can operated on front panel. At the same time, the Series power supplier has voltage meter and ohmmeter function in order to facility test. This series offer flexible solution to general laboratory and workshop requirement. This series of power with international advanced level, the main special functions and advantages as follows:

- VFD display
- Luminiferous LED key
- Convenient data entry via knob or numerical key pad
- Use cursor adjusting step value
- Very high accuracy and resolution of 0.1mV/0.1mA
- Hold during Power off memory function.
- Capable output wave based on edit voltage/current with time variations (List Mode)
- High voltage rise speed (<20mS)
- Memory capacity: 100 groups
- On time output function, time range 0.01 to 60000S
- Remote sense interface to compensate line voltage, increase output accuracy.
- External analog signal control the power input and output
- Equipped with $5\frac{1}{2}$ digital $m\Omega$ meter
- Low ripple and noise
- Intelligent fan control to saving energy and reducing noise.
- Standard dimension, capable to installed in standard cabinet with IT-E151,
- Configure with Standard communication interface RS232/USB, 25ms communication speed.
- Rich SCPI commands, convenient to build intelligent test platform.
- Provide free remote control software with strong function saving secondary development time.

Model		Voltage	current	Power
IT6121B	IT6121B(G)	20V	5A	100W
IT6122B	IT6122B(G)	32V	3A	96W
IT6123B	IT6123B(G)	72V	1.2A	86.4W
IT6132B	IT6132B(G)	30V	5A	150W

IT6133B	IT6133B(G)	60V	2.5A	150W
IT6162B	IT6162B(G)	20V	50A	1000W
IT6164B	IT6164B(G)	30V/60V	40A/20A	1200W

*IT6100B(G) is the model with built-in GPIB, the function is the same as standard model, please check with ITECH for availability.

2.2 Front Panel Introduction

Front panel of IT6121B/IT6122B/IT6123B/IT6132B/IT6133B.

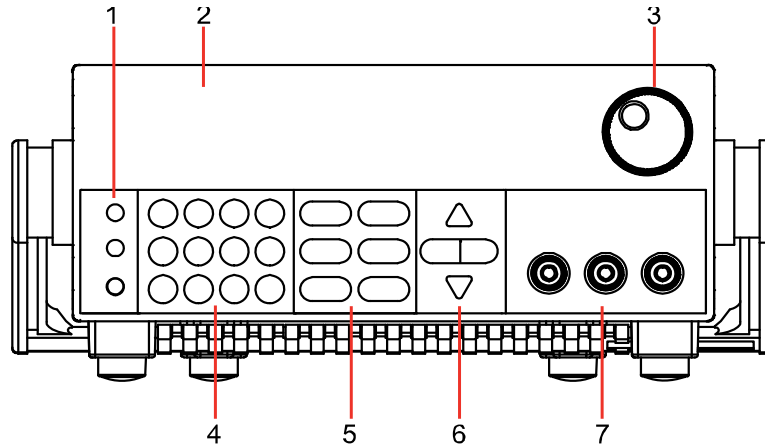

1. Shift, Local and Power
2. VFD display
3. Rotary knob
4. Numeric keys, esc button
5. Function keys
6. up/down, left/right key
7. output terminals

Front panel of IT6162B/IT6164B.

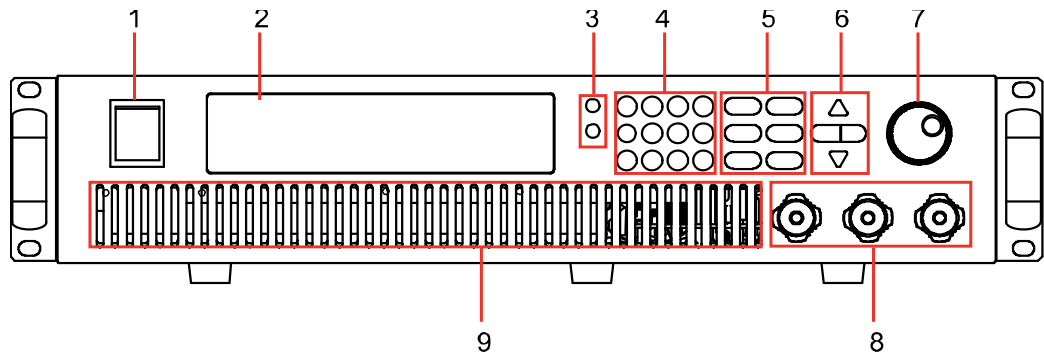

1. Power switch
2. VFD display
3. Shift and Local key
4. Numeric keys, esc button

5. Function keys
6. up/down, left/right key
7. Rotary knob
8. output terminals
9. Vent hole

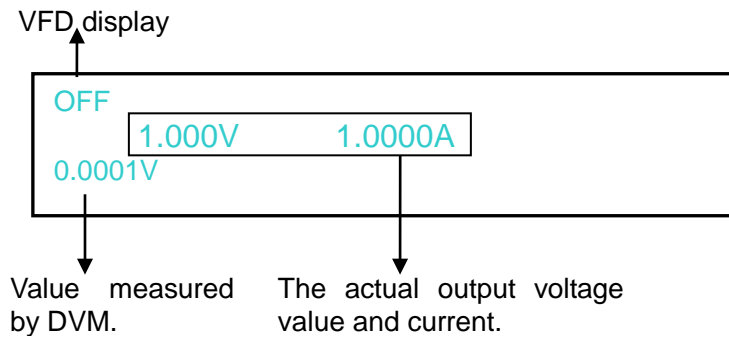

2.3 Rear Panel Introduction

Rear panel of IT6121B/IT6122B/IT6123B/IT6132B/IT6133B.

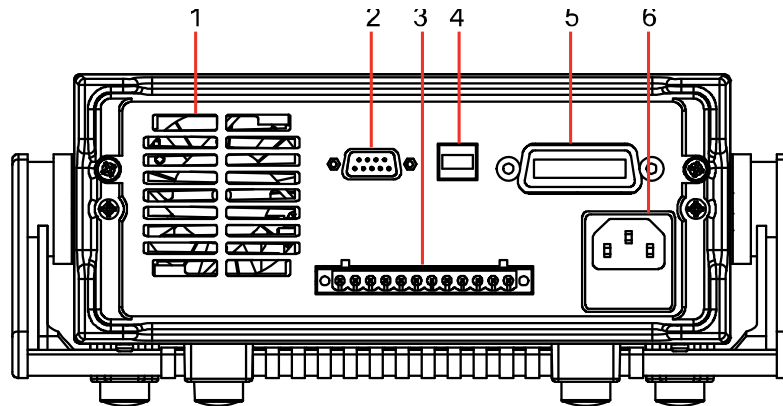

1. Ventilation holes
2. RS232 interface
3. Quick connect terminal for remote sensing and DVM terminal and external control port
4. USB interface
5. GPIB interface (Only for IT6100B(G) series)
6. AC power inlet and fuse compartment

Rear panel of IT6162B.

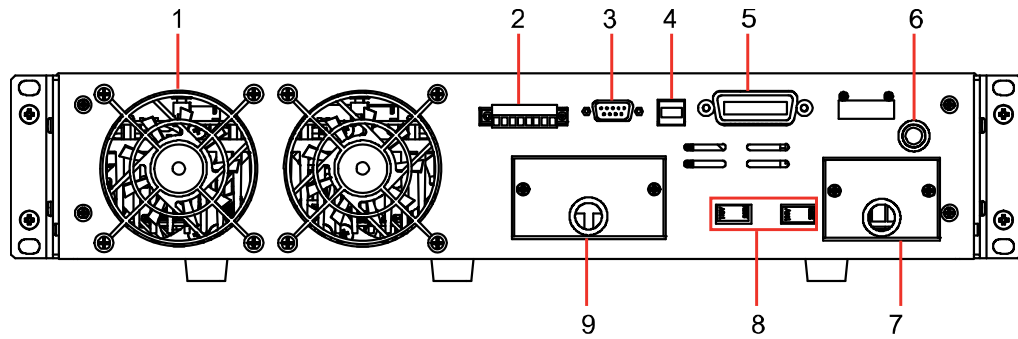

1. Ventilation holes
2. DVM terminal and external control port
3. RS232 interface
4. USB interface
5. GPIB interface (Only for IT6100B(G) series)
6. Fuse
7. AC power inlet
8. AC power selection switch
9. Output terminals and quick connect terminal for remote sensing

Rear panel of IT6164B.

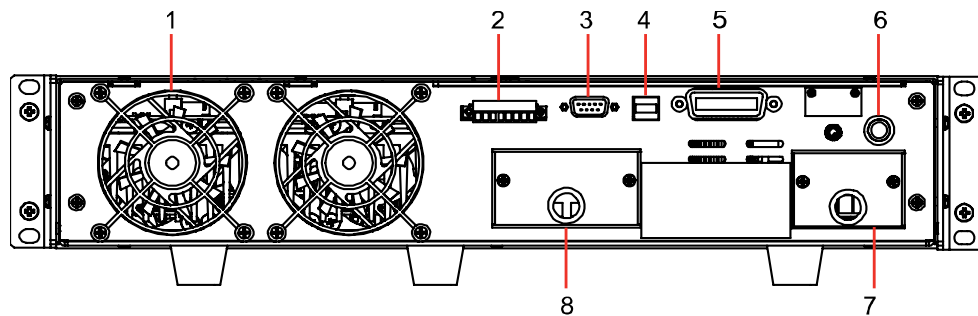





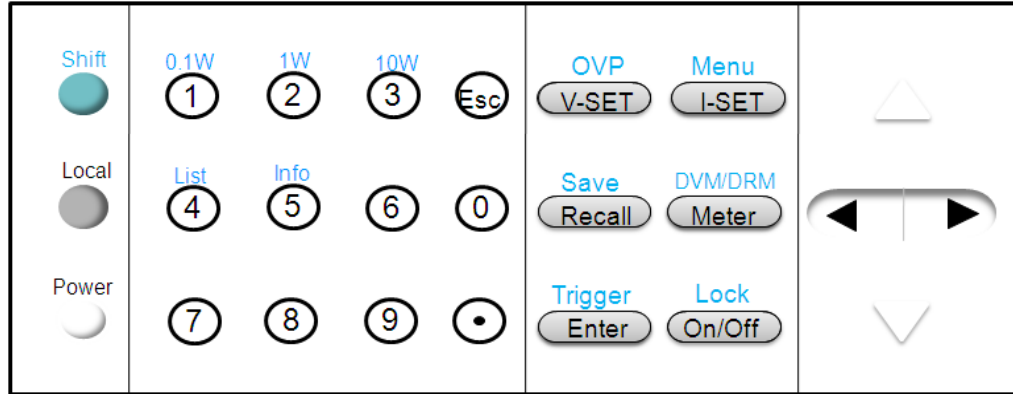

1. Ventilation holes
2. DVM terminal and external control port
3. RS232 interface
4. USB interface
5. GPIB interface (Only for IT6100B(G) series)
6. Fuse
7. AC power inlet
8. Output terminals and quick connect terminal for remote sensing

2.4 Keyboard Introduction

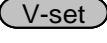
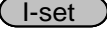
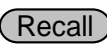
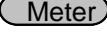
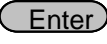
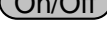

The functions of keys on the front panel of the IT6100B series power supply are shown in the following table.

Key tag	Name and function
 Shift	Use to access secondary functions
 Local	Enable front panel operation when in remote mode
 Power	Power switch
0-9	Numerical keys for direct entry of values
 V-set OVP	Set the voltage value, OVP value
 I-set Menu	Set the current value and enter into the menu
 Recall Save	Recall(Save) operating data from internal memory
 Meter DVM/DRM	Switch between Setting/Meter display, also used to switch to DVM/DRM measuring state.
 Enter Trigger	Press to confirm numerical entries, or provide a trigger signal
 On/Off Lock	Set the output state of the power supply, or to lock the front-panel keys
	Right/left keys to adjust the position of cursor
	Up/down key to overturn the menu items or increase/decrease the setting value.
 Esc	Quit the operation

Numerical keys/Secondary Shift Functions:

 1 (0.1W)	Set the range of the mΩ Meter to 0.1W
--	---------------------------------------

② (1W)	Set the range of the mΩ Meter to 1W
③ (10W)	Set the range of the mΩ Meter to 10W
④ (List)	Generate programs in List Mode
⑤ (Info)	Check the information of the power supply

2.5 Function description of VFD status indicators

IT6100B series power supply VFD indicator lamps description as follows:

Chart	Indication	Chart	Indication
OFF	Output is off currently	Rmt	Controlled in remote mode
CV	Function in CV mode	Error	Error happens.
CC	Function in CC mode	Prot	OVP function is triggered.
Shift	Shift button is pressed	Lock	Front-panel is locked
Addr	Matching address when communicate by GPIB	Srq	Power supply is in GPIB serial polling request mode
Trig	Waiting for a trigger signal	-	-

2.6 Power-on self-test

A successful self-test indicates that the purchased power product meets delivery standards and is available for normal usage.

Before operation, please confirm that you have fully understood the safety instructions.

WARNING

- To avoid burning out, be sure to confirm that power voltage matches with supply voltage.
- Be sure to connect the main power socket to the power outlet of protective grounding. Do not use terminal board without protective grounding. Before operation, be sure that the power supply is well grounded.
- To avoid burning out, pay attention to marks of positive and negative polarities before wiring.

Self-test steps

Normal self-test procedures:

1. Correctly connect the power cord. Press **Power** key to start up.
2. After self-test, if the power supply is normal, then VFD will display the output voltage and current status as below:

OFF	
0.000V	0.0000A
0.0001V	

Error Information References

The following error information may occur when an error occurs during Power On self-test:

- If the EEPROM was damaged, the VFD will display: “Eeprom Failure”.
- If the system parameters in EEPROM is lost, the VFD will display: “Initialize Lost”.
- If the latest operating data in EEPROM is lost, the VFD will display: “Eeprom Reset Error”.

Exception handling

If the power supply cannot start normally, please check and take measures by reference to steps below.

1. Check whether the power cord is correctly connected and confirm whether the power supply is powered.
 Correct wiring of power cord => 2
 Incorrect wiring of power cord => Re-connect the power cord and check whether the exception is removed.
2. Check whether the power in On. Power key is under “” On status.
 Yes => 3
 No => Please check the Power key to start power and check whether the exception is removed.
3. Check whether the fuse of power supply is burned out.
 If yes, change fuse. Detailed steps:
 - 1) Pull out power line and take out the fuse box at power line jack with a small screw driver. As shown below.

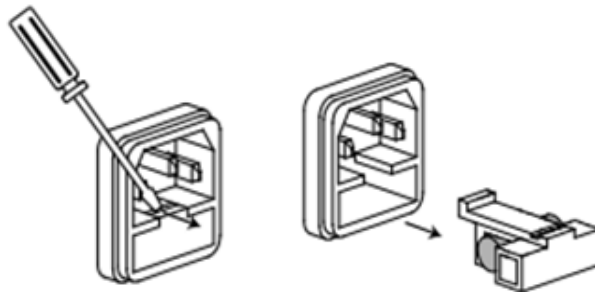

- 2) If the fuse is fused, please change fuse of same specification based on machine model. See the table below for matching information of fuse and machine model.

Products	Specification (110VAC)	Specification (220VAC)
IT6121B	T 5A	T2.5A
IT6122B	T 5A	T2.5A
IT6123B	T 5A	T2.5A
IT6132B	T 5A	T2.5A
IT6133B	T 5A	T2.5A
IT6162B	20AT	10AT
IT6164B	Does not support 110VAC input	15AT

- 3) After replacement, install the fuse box back to original position, as shown below.

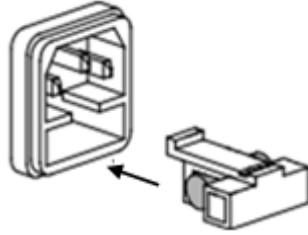
**NOTE**

Fuse of IT6162B/IT6164B can unscrew directly by hand.

Chapter3 Basic operation

This chapter describes in detail how to operate the instrument manually via the front-panel keys. This chapter is divided into the following sections:

- Local and remote operation switching
- Setting the Voltage
- Setting the Current
- On/Off Operation
- Set mode and Meter mode
- Save and recall operation
- Trigger operation
- Menu operation
- OVP function
- key lock function
- Remote Sense and digital port functions
- mΩ Meter and digital Voltage Meter

3.1 Local/Remote Mode

- (Local) button can enable you switch mode from remote to local mode.

After you power on the power supply, the power supply's default mode is local mode, all the buttons can be used in this mode. While in remote mode, you can't operate through front panel directly except Local, Meter, Shift+On/Off (Lock) keys. Local and remote mode can be controlled through PC. In addition, the mode changing will not influence the output parameters.



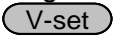

3.2 Setting the Voltage

The constant voltage range is from 0V to the maximum voltage value of each model. After pressing , the key is lit, and you can set the voltage. You have 3 solutions to set the constant voltage value.

Solution1:

Step1: Power on the IT6100B series instrument

Step2: Press 

Step2: Press   to move the cursor and press the  and  keys to change the value

Step3: Press  to confirm.

Solution2:

Step1: Power on the IT6100B series instrument

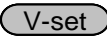
Step2: Press 

Step3: Press  to move the cursor and turn the knob to change the value

Solution3:

Step1: Power on the IT6100B series instrument

Step2: Press 

Step3: Use the numeric keys  ~  to change the voltage value.

Step4: Press  to confirm.

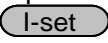

3.3 Setting the Current

The constant current output range is from 0A to the maximum current value of each model. After pressing , the key is lit, and you can set the current. It is very easy for you to set the constant current output.

Solution1:

Step1: Power on the IT6100B series instrument

Step2: Press 

Step2: Press  to move the cursor and press the  and  keys to change the value

Step3: Press  to confirm.

Solution2:

Step1: Power on the IT6100B series instrument



Step2: Press 

Step3: Press  to move the cursor and turn the knob to change the value

Solution3:

Step1: Power on the IT6100B series instrument

Step2: Press 

Step3: Use the numeric keys  to  to change the voltage value.

Step4: Press  to confirm.

3.4 On/Off Operation

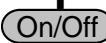
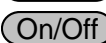
 button is used to control the output state of power supply. When  button is lit, it indicates the output is on. When output is on, the indicator CV/CC on the VFD will be lit.

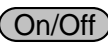
 Note: make sure you have connected power supply well first, then press  button.

3.5 Set mode and Meter mode

Set mode: you can set the voltage and current in this mode, and the voltage and current displayed on the VFD is the setting value.

Meter mode: the voltage and current displayed on the VFD is the read-back value.

Set mode and meter mode can be switched by pressing  key.

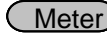
When  key is pressed, the key is lit, it is in meter mode, when press it again, it is set mode, the key is grey.

3.6 CC and CV

The power supply has a constant voltage/constant current automatic conversion feature.

When in CV mode, the power supply will provide a constant voltage, with the changes of the load, if the current increases to the current setting, then it will convert to CC mode. The power supply will provide a constant current.

CV indicator represents it's now in CV mode, CC indicator means it's now in CC mode.



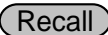
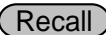









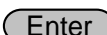

3.7 Save and recall operation

You can use  (Shift)+  (Save) or  or use the SCPI order *SAV, *RCL to store up to 10×10 different output states in storage register locations.

The parameters can be saved are: 1. Voltage set 2. Current set 3. OVP set 4. The parameters under System menu.

When recall, you should pay attention to the memory group set in the menu, details refer to chapter 5.9.

Take the example of saving parameters to memory 23 and then recall:

Step	Operation	VFD display
Save operation		
1	Press compound keys  (Shift)+  (Save)	Save <u>1</u>
2	Press numeric keys  and  , then press  to confirm	Save <u>23</u>
Change the memory group in the menu		
3	Press  (Shift)+  (Menu) to the menu	MENU Config System Edit_List
4	Press   to select "Config", press  to confirm.	CONFIG MENU Initialize Memory Out_Recal
5	Press   to select "Memory", press  to confirm	MEMORY GROUP SET group = <u>0</u>
6	Press numeric key  to set the memory group to 2	MEMORY GROUP SET group = <u>2</u>

Recall operation		
7	Press Recall (then the key is lit) , and then press numeric key 3	

3.8 Trigger operation

You need to select the trigger mode from the menu before using this function. Details refer to TRIG item in the system menu.

If the trigger source is selected to “Manual”, after you edit a list file, press **(Shift)+ Enter** (Trigger) to give a trigger signal. During the running process **Enter** button will flash all the time.

3.9 Menu Operation

3.9.1 Menu description

Press **(Shift) + I-set** (Menu) to enter menu mode. The menu parameters will be displayed on the VFD. Use up and down keys to scroll through the menu list and press **Enter** to select a menu and view the parameters. Press **ESC** to return to the higher level menu and to return to the main operating mode.

MENU	Menu	
Config	CONFIG MENU	Configuration menu
	Initialize	Reset config? Select whether to reset the config menu
		No Do not reset the config menu.
		Yes Reset the config menu.
	Memory	Memory GROUP SET Memory group set for save/recall function
		group=0 (0 - 9)
	Out_Recal	OUT RECALL Set the Power ON/OFF state after power up.
		On “Remembers” and restores the Power ON/OFF state of the power supply before power was turned off
		Off(default) Disable this function.
	Set_Recall	SET RECALL Recall operating parameters of power supply after power up
		On(default) “Remembers” and restores the operating parameters of the power supply (voltage, current settings..) before power was turned off.
		Off Disable this function. The parameters are the default set when power up.
	Buzzer	KEY BUZZER Keypad sound setting
		On Enable key sound
		Off(default) Disable key sound
	Knob	KNOB LOCK Enable/disable the rotary knob.

		On	Lock the rotary knob
		Off(default)	Unlock the rotary knob
	Comm	COMMUNICATION	Communication port select
		RS232(def)	RS232
		USBTMC	USB
		GPIB (Only for IT6100B(G) series)	GPIB
	Port	PORT FUNCTION	Select mode of digital port
		Trigger	Trigger mode
		RI/DFI	Power switch control and discrete fault indication
		Digital	Data port
	Trig	TRIGGER SOURCE	Trigger source select
		Manual	Trigger by keys on the front panel
		External	Ext. Trigger signal is applied to the digital port in the rear panel.
		Bus	Remote command trigger mode.
		Immediat	Trigger by TRIG:IMM command
	RI	RI MODE	Config RI (Remote Inhibit) mode
		Off	Disable this function
		Latching	At the falling edge of the TTL level, the output turns on.
		Live	The output is on at high level and turned off at low level.
	DFI	DFI SOURCE	Config DFI (Discrete Fault Indicator) mode
		Off	Disable this function
		QUES	Question bit
		OPER	Operation bit
		ESB	Event State bit
		RQS	Require bit
System	SYSTEM MENU	System menu	
	Limit_volt	LIMIT VOLTAGE SET	Limit voltage setting
		Limit=30.10V	
	On_Timer	ON TIMER STATE	Output timer function state
		On	ON TIMER SET
			timer = 60.000(0.01 - 60000.0S)
		Off(default)	Turn off the output timer.
	DVM	DVM RANGE	Digital multimeter range setting
		Auto	Auto range
		Low	Low range
		High	High range
	OutMode	OUTPUT MODE...	Set Output Mode
		Volt-Wave Prio	Voltage output priority
		Curr-Wave Prio	Current output priority
Range	RANGE MENU	Set Output Range	
		Low_Range	Low range

		High_Range	High range
Edit_List	RECALL LIST FILE	Recall the existing list file.	
	Recall_1		

NOTE

Only IT6162B/IT6164B Power contain OutMode function.

3.9.2 Menu function

Memory group (Memory)

Power supply can save some often-used parameters in a nonvolatile memory (capacity is 10*10 groups). This function can make the operations more convenient. Customer can save and recall parameters quickly.

GRP0: This indicates saving power supply parameters in memory location 0-9.

GRP1: This indicates saving the parameters in memory location 10-19.

GRP2-GRP9 by parity of reasoning.

Output Recall (Out_Recall)

This function can help you set the output state when the power supply is powered on. If you select **On**, the power supply will keep the state of last time as it is turned off. If you select **Off**, this function is disabled. **Default is On.**

Set_Recall

This item can set power on state of parameters. If you select OFF item, then all the parameters will be initialized to the factory setting. Output voltage and current will always be 1V/0.1A. Otherwise the output value will be the same with last power off state. The default setting is ON.

Key sound set (Buzzer)

This item can set the key sound state. If in ON mode, then when you press a button, the power supply will beep. If in OFF mode, the beeper will not make a sound. The default set is in OFF mode.

Rotary knob set (KNOB)

This item is used to set rotary knob lock state. In OFF mode, you can use this rotary knob to set the output value and overturn the menu items. If knob lock is in ON mode, the knob can't be used. The default setting is in OFF mode.

Communication (COMM)

IT6100B power supply support standard communication interfaces: RS232/USB. In this option, you can select the communication interface according to your demands.

(Only for IT6100B(G) series) The range of GPIB address is 0-30.

Baudrate can be chosen when communicate with RS232---4800, 9600, 19200, 38400, 57600, 115.2K. Data bit is 8, Check digit have three choices:

NONE, ODD, EVEN.

Before you begin to carry out communication, please make sure the configure in our unit agrees with PC configure. More information please refer to chapter 6.

PORT mode

A 4-pin connector in the rear panel is provided for digital input and output signals.

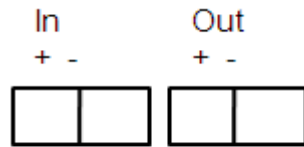

This digital port can be configured to provide Fault/Inhibit, External Trigger or Digital I/O functions. The signal level is TTL.

Choose one mode in the menu:

Trigger: select the port mode as trigger, In(+) function as TRIG pin, In(-) function as GND

RI/DFI: The Inhibit Input pin can be used to control the output state of the power supply (RI function). The Fault Output pin (DFI function) can be used to indicate internal faults of the power supply.

Digital: Digit I/O port, Read and control output and input state of the 2 available pins.

The default set is Trigger.

Pin \ Mode	Trigger	RI/DFI	Digital I/O
In +	Trigger in	Inhibit Input	Digital Input
In -	GND	GND	GND
Out +	No Use	Fault Output	Digital Output
Out -	No Use	GND	GND

Trigger source (TRIG)

The power supply supports 4 different trigger modes for LIST test. Manual, External, Bus and Immediat. Configure one of the trigger sources before performing trigger operation:

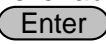
Manual: When this function is enabled, you can generate an immediate trigger pulse by pressing  (Shift)+  (Trigger)

External: External trigger signal (TTL), you should set PORT as Trigger in the menu at the same time. When this function is enabled, the power supply can be triggered with a low TTL pulse applied to pin In + and In - (short In + and In -) of the terminal connector in the rear. The TTL on pulse width should be at least 5 ms.

Bus: When this function is enabled, you can trigger the power supply by sending a TRIGGER command to the power supply

Immediat: You can trigger the power supply by sending the command TRIG: IMM in any case, regardless of the trigger source selected in the current menu.

The default set is Manual

Remote Inhibit (RI)

Used to turn off the output of the power supply. Can be used to turn off several power supplies simultaneously.

The input terminals are In + and In -

The RI input has 3 modes: LATCHING, LIVE and OFF

OFF: The signal applied to the RI port does not affect the output state of the power supply.

Latching: When In + and In - are shorted, the output will be OFF, the VFD displays "RI" at the same time; When disconnect In + and In -, the output will remain OFF.

Live: When In + and In - are shorted, the voltage will change to 0V, (check in METER mode and ON state), the VFD displays "RI" at the same time; When disconnect In + and In -, the power supply will output as the voltage setting. "RI" on the VFD will disappear.



Note: when use RI function, the PORT item in menu should be selected to RI/DFI.

Discrete Fault Indicator (DFI)

The output level of DFI (Out + and Out -) reflects the state of the register bit.

The DFI function can be activated by state changes of the QUES, OPER, ESB, RQS bits

Off: The output level of the DFI port remains high.

QUES: The output level of DFI reflects the state of the QUES bit. When the QUES bit is 1, the DFI output goes to a high level.









OPER: The output level of DFI reflects the state of the OPER bit.

ESB: The output level of DFI reflects the state of the ESB bit.

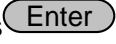
RQS: The output level of DFI reflects the state of the RQS bit.

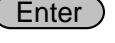
When use DFI function, the PORT item in the menu should set to RI/DFI.

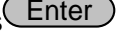
The operation:

1. Press  (Shift) +  (Menu) to menu, press  to select Config, press  to confirm.
2. Press  to select Port, press  to confirm.
3. VFD display **Trigger RI/DFI Digital**, Press  to select **RI/DFI**, press  to confirm.
4. VFD return to **Comm Port Trig RI DFI**, press  to select **DFI**, press  to confirm.

- Select DFI source, e.g., OPER, then press  to confirm.

When the value in operation register changes, the TTL level of Out + and Out – will change simultaneously.

The default set of config menu

Memory	group 0
Out_Recal	Off
Set_Recall	On
Buzzer	Off
Knob	Off
Comm	RS232
Port	Trigger
Trig	Mauual
RI	Off
DFI	Off





Limit voltage (Limit_Volt)

Limit voltage range is 0V - Vmax.

Limit voltage is used to limit the voltage setting for a certain device under test.

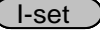
For example: the limit voltage is set to 12V, when you set voltage to 15V (over 12V), then the voltage will auto adjust to 12V.

The operation to set voltage limit:

- Press  (Shift) +  (Menu) to menu
- Press  to System menu, press  to confirm
- Select Limit_Volt in System menu, Press  to set the voltage limit

The default set of Limit_volt is the max rated voltage.

ON TIMER STATE

This item is used to set the “time on- load” function. In **ON** mode, the indicator light “**Timer**” will be lit on the VFD screen. When output of power supply is enabled, timer will begin to work, after reaching the definite time, output will be off automatically. If in OFF mode, the timer function will not be enabled. The default set is **OFF**.

RESET

This item is used to reset all items in the menu. If you select >YES, then unit will restored to factory setting. If you select >NO, all setting in the menu will remain unchanged.

OutMode (IT6162B/IT6164B Specific function)

This item is used to set the power supply output mode, including Volt-Wave Prio (voltage priority) mode and Curr-Wave Prio (current priority) mode. Under voltage mode, when output wave quality is maintained, current may overshoot; under

current mode, when current output wave quality is maintained, voltage rise speed will get slower.

Voltage Range (IT6164B Specific function)

IT6164B is a double-range output power supply. This item is used to set the voltage/current output range: High and Low. As shown below.

Model	Voltage Range	Output range
IT6164B	High	Voltage output range: 0V ~ 60V
		Current output range: 0A ~ 20A
	Low	Voltage output range: 0V ~ 30V
		Current output range: 0A ~ 40A







List Set

This mode allows you to create a sequence of steps, store it into the power supply's nonvolatile memory and execute it.

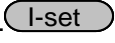

The input parameters for generating a list include the name of the list file, the input steps (no more than 999 steps), the step time (the minimum is 1 mS) and the value of each step.

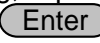
After you finish the editing process and enable LIST mode, if you receive a trigger signal, power supply will begin to work according to the sequence steps you've edited.

Choose a trigger source in the menu, take MANUAL for example:

Press  (Shift)+  (Menu) to system menu, and press  to select Config, press  to confirm. Press  to select Trig, press ,  to select trigger source as Manual, press  to confirm.













The operation to edit a LIST with 2 steps:

Step	Operation	VFD display	Description
1	Press  (Shift)+  (Menu) to menu	MENU Config System Edit_List	
2	Press  to select Edit_List , press Enter to confirm, and then set the LIST name	RECALL LIST FILE Recall <u>5</u>	Recall LIST file, when recall a List file already saved, press Esc in the next step.
3	Set the run mode of LIST, select Continuous	LIST MODE Continuous Step	Continuous: LIST will run continuously; step: another trigger signal should be sent when run a new step. Here, take Step as example.
4	Set the list repeat count	LIST COUNT SET Repeat= <u>2</u>	Repeat count range:1~65535
5	Set List step count	LIST STEP SET Total Step= <u>3</u>	Total step range:2~999 (1 can be set, but it makes no sense)
6	Set the voltage for the 1th step	LIST VOLTAGE SET step001= <u>12.000</u> V	Voltage range: 0~Vmax

7	Set the current for the 1th step	LIST CURRENT SET step001=1.0000A	Current range: 0~Imax
8	Set the time width for the 1th step	LIST WIDTH SET step001=2.000S	Time range: 0.001~3600S, if LIST mode in step 3 is set as Step, then no time width can be set.
9	Set the voltage for the 2nd step	LIST VOLTAGE SET step002=8.000V	Voltage range: 0~Vmax
10	Set the current for the 2nd step	LIST CURRENT SET step002=1.0000A	Current range: 0~Imax
11	Set the time width for the 2nd step	LIST WIDTH SET step002=2.000S	Time range: 0.001~3600S, if LIST mode in step 3 is set as Step, then no time width can be set.
12	Save List file	SAVE LIST FILE Save <u>5</u>	Range: 1~7



Run LIST:

Take **step mode** and trigger source as **manual** for example.

Step	Operation	VFD display	Description
1	Press  (Shift)+  (List) to select the LIST to be run.	Run List <u>5</u>	-
2	Press Enter to confirm.	L5: EE	Enter key is lit
3	Press  (Shift) +  (Trigger) to trigger	L5:00001:01	The 1st step of the first count
4	Press  (Shift) +  (Trigger) to trigger	L5:00001:02	The 2nd step of the first count
5	Press  (Shift) +  (Trigger) to trigger	L5:00002:01	The 1st step of the second count
6	Press  (Shift) +  (Trigger) to trigger	L5:00002:02	The 2nd step of the second count
7	Press  (Shift) +  (Trigger) to trigger	L5: EE	The selected List file runs to the end.

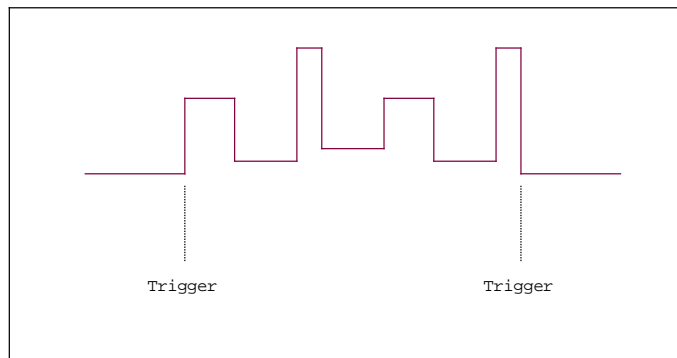
Press **Esc** to escape the List in any case.

NOTE

In editing LIST, IT6164B has more modes for selection. Press   to select Edit_List, and press Enter to confirm. The panel displays: Speed Prio (high speed mode) and Power prio (normal mode). Under normal mode, time range is set from 500mS. For mode switch, follow normal process. Under high speed mode, time range is set from 10mS with step of 1mS. The mode is maintained at high range, and if triggered, voltage will be directly output.

3.10 OVP

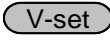
IT6100B series power supply provide OVP function, press  (Shift) +  (OVP) button can enable you to set the over voltage protection value, when it's enabled, "Prot" will display on the VFD.



Over voltage may be caused by internal defect or customer's incorrect operation (such as output voltage rising), or external voltage too high. Once power supply is protected (OVP), the output will be off immediately and "OVP" indicator light will be lit, the instrument will issue 3 beep(regardless of the buzzer set in the menu).

Avoid external voltage that across the output terminals exceeding the 120% of rated voltage or it will damage out power supply!

When power supply in OVP state, please check the external factors first, after you exclude the external factors, press ON/OFF button to enable output again. If in communication state originally, you should send command OUTP ON to enable output.

3.11 Key Lock

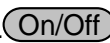
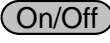
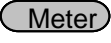
Key lock function can prevent any incorrect touching on the keypad.

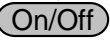
Press  (Shift)+  (Lock) button to set the key lock state. If keyboard has been locked, the indicator light * will display on the VFD .In addition, when key board are lock, all buttons can't be used but  ,  ,  (Shift).Press  (Shift)+  (Lock) once again will relieve key lock function.

3.12 Terminals at rear panel

The terminals at rear panel of IT6100B include: remote sense, DVM and milliohm meter, I/O port.

The terminals at rear panel of IT6121B/IT6122B/IT6123B/IT6132B/IT6133B.

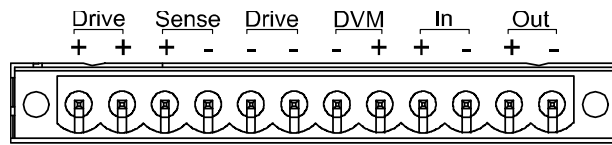

The terminals at rear panel of IT6160B.

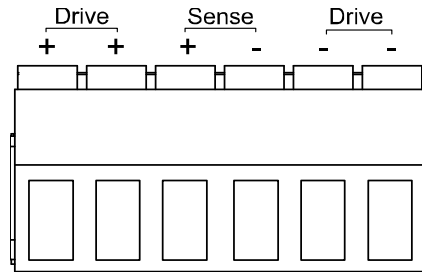
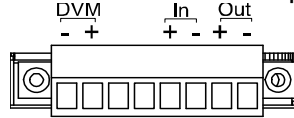

3.12.1 Remote sense

Remote voltage sensing is used to maintain good regulation at the load and reduce the degradation of regulation that would occur due to the voltage drop in the leads between the power supply and the load. By connecting the supply for remote voltage sensing, voltage is sensed at the load rather than at the supply's output terminals. This will allow the supply to automatically compensate for the voltage drop in the load leads and improve regulation.

Local sense

Local sense doesn't compensate for the voltage drop on the wire, the operation is:

1. Use the shorting clip already installed on the rear panel, or install wires between Drive+ and Sense+, Drive- and Sense-.
 2. Connect the positive and negative terminals on the front panel or the Drive + Drive- terminals on the rear panel to the device under test (DUT).
- Wiring Schematic Diagram of Local Measurement of IT6121B/IT6122B/IT6123B/IT6132B/IT6133B is as follows:

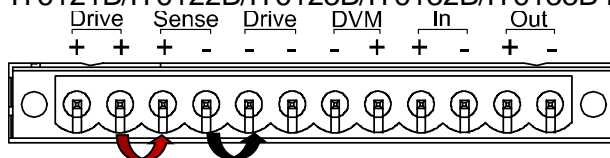

- Wiring Schematic Diagram of Local Measurement of IT6162B/IT6164B is as follows:

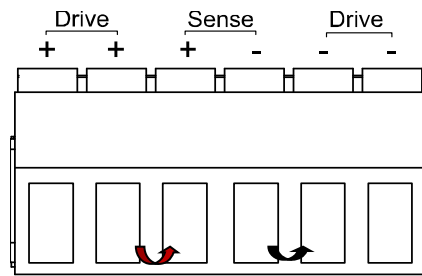

Remote sense

Remote sense can compensate for the voltage drop on the wire, the operation is:

1. Uninstall the wire or shorting clip between the Drive+ and Sense+, Drive- and Sense-
2. Connect a couple of wires from Sense+, Sense- and the device under test
3. Connect wires from positive and negative terminals on the front panel or the Drive+ and Drive- terminal to DUT

Wiring Schematic Diagram of Remote Measurement is as follows:

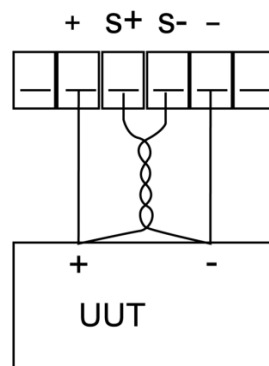

NOTE

In order to ensure the stability of the system, please install armored twisted pair cable from Sense+ , Sense- and the device under test.

3.12.2 Digital Volt Meter (DVM) and Milliohm Meter





The power supply provides a built-in 5 1/2 Digital Volt meter and milliohm meter.

Digital Volt Meter (DVM)

Digital Voltage Meter can be used to measure external DC voltage, the range is: 0~40V. IT6162B/IT6164B measurement range is: -40V~40V.

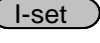
The connectors are in the rear panel. The voltage value is displayed on the bottom left field of the display.

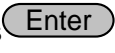
The operation to adjust the voltage meter range is:

1. Press  (Shift)+  (Menu) to menu
2. Press  to enter System menu, press  to confirm
3. Press  to select DVM, press  to confirm

4. VFD display “Auto Low High”, indicating the range

Auto: auto range, when voltage is below 18V, the resolution is 0.1mV; when voltage is over 18V, the resolution is 1mV

Low and High is low or high range, when in low range, the voltage resolution is 0.1mV; when in high range, the voltage resolution is 1mV

To measure voltages, connect the leads as shown here:

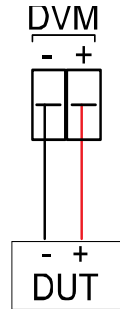

Milliohm Meter

The instrument is also equipped with a Milliohm Meter which can accurately measure resistance up to 1kΩ.

To protect the resistor, make sure to select an appropriate power range before connecting it to the power supply.

The range for the milliohm meter can be selected are: 0.1W, 1W, 10W.

To measure resistance, connect the resistor as shown below:

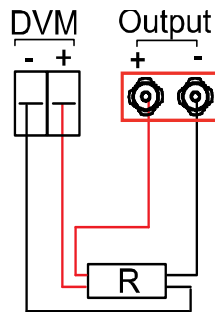

NOTE

The wires at the positive and negative terminal of the DVM should be connected at the root of the resistance to be measured!

Switching operation of DVM and milliohm meter

Press  (Shift)+  (DVM/DRM)

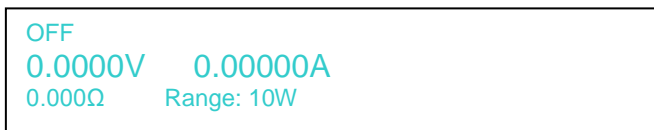

Operation to adjust milliohm meter range

When in milliohm meter mode, press  (Shift) +  can set the range to 0.1W



Press  (Shift) +  set the range to 1W

Press  (Shift) +  set the range to 10W

3.13 Power information

The information include: Model, program version, serial number (SN).

Operation to check:

Press  (Shift) +  (Info) to check model and program version, and  to check SN.

Chapter4 Specification

4.1 Specification

Parameter		IT6121B	IT6122B	IT6123B	IT6132B	IT6133B
Output Ratings	voltage	0-20V	0-32V	0-72V	0-30V	0-60V
	current	0-5A	0-3A	0-1.2A	0-5A	0-2.5A
	power	100W	96W	86.4W	150W	150W
Line regulation	voltage	<0.01%+1mV	<0.01%+1mV	<0.01%+1mV	<0.01%+1mV	<0.01%+2mV
	current	<0.05%+1mA	<0.05%+1mA	<0.05%+1mA	<0.05%+1mA	<0.05%+0.05mA
Load regulation	voltage	<0.01%+2mV				
	current	<0.05%+0.1mA	<0.05%+0.1mA	<0.05%+0.1mA	<0.05%+1.5mA	<0.05%+0.5mA
Ripple&Noise (20HZ-7MHZ)	voltage	<1mv Vrms	<1mv Vrms	<1mv Vrms	<1mv Vrms	<1mv Vrms
		<3mv Vpp	<3mv Vpp	<4mv Vpp	<4mv Vpp	<5mv Vpp
	current	<3mA rms	<3mA rms	<3mA rms	<4mA rms	<3mA rms
Setup resolution	voltage	1mV	1mV	1mV	1mV	1mV
	current	0.1mA				
Setup accuracy	Voltage	±0.03%+3mV	±0.03%+3mV	±0.03%+6mV	±0.03%+3mV	±0.03%+6mV
	Current	±0.05%+2mA	±0.05%+2mA	±0.05%+1mA	±0.05%+2.5mA	±0.05%+1.5mA
Readback resolution	Voltage	0.1mV	0.1mV	0.1mV	0.1mV	0.1mV
	current	0.01mA	0.01mA	0.01mA	0.01mA	0.01mA
Readback accuracy	Voltage	±0.02%+3mV	±0.02%+3mV	±0.02%+5mV	±0.02%+3mV	±0.02%+5mV
	Current	±0.05%+2mA	±0.05%+2mA	±0.05%+1mA	±0.05%+2.5mA	±0.05%+1.5mA
Response time						
Response time		<200uS	<200uS	<200uS	<200uS	<200uS
Rising time (From 10%-90%FS)		<20mS	<20mS	<20mS	<20mS	<20mS
Falling time (From 90%-10%FS)		<200mS	<150mS	<150mS	<250mS	<200mS
OVP	Range	1-19V	1-31V	1-71V	1-29V	1-59V
	accuracy	±(setting value*0.5%+0.5V)				
	Response time	<10mS				

DVM(DC)	
Readback accuracy	$\pm 0.02\% + 10\text{mV}$
Readback resolution	$0.1\text{mV} (< 10\text{V}) ; 1\text{mV} (> 10\text{V})$
Difference-mode voltage	0-40Vpk
Common-mode voltage	0-30Vpk
Common-mode rejection ratio	$< 0.1\%$
Weight(net)	7Kg

Parameter		IT6162B
Rated value (0 °C-40 °C)	Voltage	0-20V
	Current	0-50A
	Power	1000W
Load regulation \pm (%of Output+Offset)	Voltage	$\leq 0.01\% + 10\text{mV}$
	Current	$\leq 0.1\% + 10\text{mA}$
Line regulation \pm (%of Output+Offset)	Voltage	$\leq 0.02\% + 2\text{mV}$
	Current	$\leq 0.1\% + 2\text{mA}$
Setup resolution	Voltage	1mV
	Current	1mA
Readback resolution	Voltage	1mV
	Current	1mA
Setup accuracy (Within twelve months 25°C \pm 5°C) \pm (%of Output+Offset)	Voltage	$\leq 0.02\% + 2\text{mV}$
	Current	$\leq 0.1\% + 25\text{mA}$
Readback accuracy (Within twelve months 25°C \pm 5°C) \pm (%of Output+Offset)	Voltage	$\leq 0.02\% + 2\text{mV}$
	Current	$\leq 0.05\% + 15\text{mA}$
Ripple (20Hz -20MHz)	Voltage	$\leq 4\text{mVp-p} / 1.2\text{mV rms}$
	Current	$\leq 15\text{mA rms}$
Tem coefficient (%of Output/°C+Offset)	Voltage	$0.01\% + 2\text{mV}$
	Current	$0.01\% + 20\text{mA}$
Readback Tem coefficient (%of Output/°C+Offset)	Voltage	$0.01\% + 2\text{mV}$
	Current	$0.01\% + 15\text{mA}$
Rising Time at no load	Voltage	$\leq 1\text{mS}$
Rising time at full load	Voltage	$\leq 1\text{mS}$
Falling time at no load	Voltage	$\leq 50\text{mS}$
Falling time at full load	Voltage	$\leq 1\text{mS}$
Dynamic response time		$\leq 200\mu\text{S}$
AC input	Voltage1	$110\text{V} \pm 10\%$
	Voltage2	$120\text{V} \pm 10\%$
	Voltage3	$220\text{V} \pm 10\%$
	Voltage4	$230\text{V} \pm 10\%$
	Frequency	47HZ-63HZ
Setup stability -30min (%of Output +Offset)	Voltage	$0.01\% + 2\text{mV}$
	Current	$0.1\% + 20\text{mA}$
Setup stability -8h (%of Output +Offset)	Voltage	$0.015\% + 2\text{mV}$
	Current	$0.15\% + 20\text{mA}$
Readback stability-30min (%of Output +Offset)	Voltage	$0.01\% + 2\text{mV}$
	Current	$0.1\% + 20\text{mA}$
Readback stability -8h (%of Output +Offset)	Voltage	$0.015\% + 2\text{mV}$
	Current	$0.15\% + 20\text{mA}$
Fuse specification		10A (Voltage3, 4) / 20A (Voltage1, 2)

Remote sense compensation	1V
Programming response time	20mS (AVG)
Power factor	0.7Max
Maximum input current	20A
Maximum input apparent power	2400VA
Storage temperature	-10°C~70°C
Protect function	OVP/OCP/OTP
Communication Interface	USB/RS232
Withstand voltage(output to the ground)	200V
Operating temperature	0~40°C
Dimension (mm)	483mmW*88.4mmH*664.1mmD
Weight (Kg)	30Kg
DVM	
Display accuracy	Low Range (0 ~±5.5V) ≤±1.5mV
	High Range (0 ~±40V) ≤0.02%±3mV
Display Temp.coefficient (% of Input/°C +Offset)	0.02%+2 mV
Display stability -30min (% of Output +Offset)	0.02%+2 mV
Display stability -8 h (% of Output +Offset)	0.02%+2.5 mV
Measurement range	-40V - +40V
Input Common-mode voltage	< 200Vdc

Parameter		IT6164B	
Rated value (0 °C-40 °C)	Voltage	0-30V	0-60V
	Current	0-40A	0-20A
	Power	1200W	
Load regulation ±(%of Output+Offset)	Voltage	≤0.01%+10mV	
	Current	≤0.1%+10mA	
Line regulation ±(%of Output+Offset)	Voltage	≤0.02%+2mV	
	Current	≤0.1%+2mA	
Setup resolution	Voltage	1mV	
	Current	1mA	
Readback resolution	Voltage	1mV	
	Current	1mA	
Setup accuracy (Within twelve months 25°C±5°C) ±(%of Output+Offset)	Voltage	≤0.02%+6mV	
	Current	≤0.1%+15mA	
Readback accuracy (Within twelve months 25°C±5°C) ±(%of Output+Offset)	Voltage	≤0.02%+6mV	
	Current	≤0.05%+15mA	
Ripple (20Hz -20MHz)	Voltage	≤ 5mVp-p / 1.2 mV rms	
	Current	≤15mArms	
Tem coefficient (%of Output/°C+Offset)	Voltage	0.01%+2mV	
	Current	0.01%+20mA	
Readback Tem coefficient	Voltage	0.01%+2mV	

(%of Output/°C+Offset)	Current	0.01%+15mA	
Rising Time at no load	Voltage	$\leq 1\text{mS}^1$	$\leq 2\text{mS}^1$
Rising time at full load	Voltage	$\leq 1\text{mS}^1$	$\leq 2\text{mS}^1$
Falling time at no load	Voltage	$\leq 50\text{mS}^1$	$\leq 120\text{mS}^1$
Falling time at full load	Voltage	$\leq 1\text{mS}^1$	$\leq 2\text{mS}^1$
Dynamic response time		$\leq 200\text{uS}^2$	
AC input	Voltage	220V \pm 10%	
	Frequency	47HZ-63HZ	
Setup stability -30min (%of Output +Offset)	Voltage	0.01%+2mV	
	Current	0.1%+20mA	
Setup stability -8h (%of Output +Offset)	Voltage	0.015%+2mV	
	Current	0.15%+20mA	
Readback stability-30min (%of Output +Offset)	Voltage	0.01%+2mV	
	Current	0.1%+20mA	
Readback stability -8h (%of Output +Offset)	Voltage	0.015%+2mV	
	Current	0.15%+20mA	
Fuse specification		T 15A	
Remote sense compensation		1V	
Programming response time		20mS (AVG)	
Power factor		0.7Max	
Maximum input current		15A	
Maximum input apparent power		3000VA	
Storage temperature		-10°C~70°C	
Protect function		OVP/OCP/OTP	
Communication Interface		USB/RS232	
Withstand voltage(output to the ground)		200Vdc	
Operating temperature		0~40°C	
Dimension (mm)		483mmW*88.4mmH*664.1mmD	
Weight (Kg)		30Kg	
DVM			
Display accuracy		Low Range (0 ~ \pm 5.5V)	$\leq \pm 1.5\text{mV}$
		High Range (0 ~ \pm 40V)	$\leq 0.02\% \pm 3\text{mV}$
Display Temp.coefficient (% of Input/°C +Offset)		0.02%+2 mV	
Display stability -30min (% of Output +Offset)		0.02%+2 mV	
Display stability -8 h (% of Output +Offset)		0.02%+2.5 mV	
Measurement range		-40V - +40V	
Input Common-mode voltage		< 200Vdc	

(*1) Indicates the interval at which the output waveform changes by 10% to 90%.

(*2) Indicates the interval at which the load changes 50-100% and the output voltage recovers to within 75 mV of the set value.

*The above specifications may be subject to change without prior notice.

Chapter5 Remote Operation Mode

IT6100B configure with communication interface RS232, USB for user adopting any of it flexible.

5.1 RS232 interface

There is a DB9 connector at the rear of the power supply, when connect to computer, you need to connect a cable with COM port on both side; active connection, you need to set the front panel composite press (Shift) + I-set key configuration settings the same as computer configuration settings. RS-232 interface can be used to program all of the SCPI orders.



NOTE

RS232 settings must match the settings in front panel system information. If any change, please press (Shift) + I-set key.

RS-232 data format

RS-232 data is a 10-bit word which has a start bit and a stop bit. The start bit and stop bit can not be edited. However, you can select the parity items with (Shift) + I-set key on the front panel.

Parity options are stored in nonvolatile memory.

Baud Rate

The front panel (Shift) + I-set button allow the user to select a baud rate which is stored in the non-volatile memory: 4800/9600/19200/38400/57600/115200

RS-232 connection cable

Use a RS232 cable with DB-9 interface, RS-232 serial port can connect with the controller (eg PC). Do not use blank Modem cable. Below table shows the plug pins.

If your computer is using a RS-232 interface with DB-25 connector, you need a adapter cable with a DB-25 connector at one end and the other side is a DB-9(not blank modem cable)



Base pin number	Description
1	No conjunction
2	TXD, data transmission
3	RXD, data receiving
4	No conjunction
5	GND, grounding
6	No conjunction
7	CTS, clear to send
8	RTS, request to send

9	No conjunction
---	----------------

RS-232 Troubleshooting:

If there is RS-232 connection problem, check the following:

Computer and power supply must configure the same baud rate, parity, data bits and flow control options. Note that the power configuration as a start bit and a stop bit (these values are fixed).

As described before in RS-232 connector, you must use the correct interface cable or adapter. Note that even if the cable has the right plug, the internal wiring may be wrong.

Interface cable must be connected to the correct serial port on the computer (COM1, COM2, etc.).

Communication Settings

Before communication, you should first make the following parameters of power supply and PC matches.

Baud Rate: 9600 (4800, 9600, 19200, 38400, 57600, 115200). You can enter the system menu from the front panel, and then set the baud rate.

Data bits: 8

Stop Bits: 1

Calibration (none, even, odd)

EVEN 8 data bits, have even parity

ODD 8 data bits have odd parity

NONE 8 data bits, no parity

Local Address: (0 ~ 31, the factory default setting is 0)

Parity=None	Start Bit	8 Data Bits	Stop Bit
-------------	-----------	-------------	----------

5.2 USB interface

Use a Cable with two USB port to connect the power and the computer. All power functions can be programmed via USB.

The USB488 interface functions of the power supply described as below:



- Interface is 488.2 USB488 interface.
- Interface receiver REN_CONTROL, GO_TO_LOCAL, and LOCAL_LOCKOUT request.
- Interface receives MsgID = TRIGGER USBTMC order information, and will pass TRIGGER order to the functional layer.

Power USB488 device functions described as follows:

- Devices can read all of the mandatory SCPI orders.
- Device is SR1 enabled.

- Device is RL1 enabled.
- Device is DT1 enabled

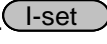
5.3 GPIB interface (Only for IT6100B(G) series)

First, Connect the GPIB interface on the power supply and the GPIB card on computer via IEEE488 bus, must be full access and tighten the screws. Then set the address, the address range of the power : 0 to 30, can set by the function key on the front panel, press the  (Shift)+  key to enter the system menu function, find the GPIB address setting by  button, type the address,  key to confirm. GPIB address is stored in nonvolatile memory line

5.4 Communication protocol

IT6100B programming should adopt SCPI communication protocol, please contact ITECH to get the protocol you need.

Appendix

Specifications of Red and Black Test Lines

ITECH provides you with optional red and black test lines, which individual sales and you can select for test. For specifications of ITECH test lines and maximum current values, refer to the table below.

Model	Specification	Cross section	Length
IT-E301/10A	10A	-	1m
IT-E301/30A	30A	6mm ²	1.2m
IT-E301/30A	30A	6mm ²	2m
IT-E301/60A	60A	20mm ²	1.5m
IT-E301/120A	120A	50mm ²	2m
IT-E301/240A	240A	70mm ²	1m
IT-E301/240A	240A	70mm ²	2m
IT-E301/360A	360A	95mm ²	2m

For maximum current of AWG copper wire, refer to table blow.

AWG	10	12	14	16	18	20	22	24	26	28
The Maximum current value(A)	40	25	20	13	10	7	5	3.5	2.5	1.7

Note: AWG (American Wire Gage), it means X wire (marked on the wire). The table above lists current capacity of single wire at working temperature of 30°C. For reference only.

Contact Us

Thank you for purchasing ITECH products. If you have any doubt about this product, please contact us as follow.

1. Visit ITECH website www.itechate.com.
2. Select the most convenient contact for further consultation.