

400U SERIES ROCKER SWITCH

- ANTI-VANDAL SWITCHES
- DETECTOR SWITCHES
- DIP SWITCHES
- KEYLOCK SWITCHES
- NAVIGATION SWITCHES
- PUSHBUTTON SWITCHES
- ROCKER SWITCHES**
- ROTARY SWITCHES
- SLIDE SWITCHES
- SNAP ACTION SWITCHES
- TACTILE SWITCHES
- TOGGLE SWITCHES
- CAP OPTIONS

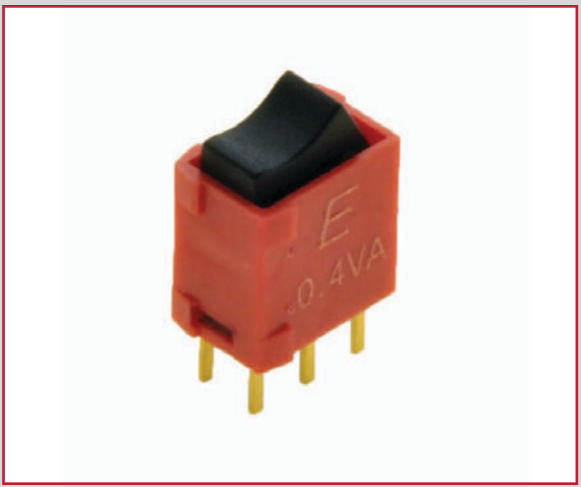

APPLICATIONS / MARKETS

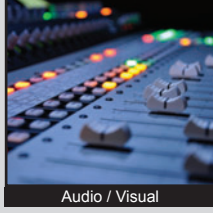

Audio / Visual



Consumer Electronics



Vending Machines



Kiosks



Instrumentation



Medical Equipment

RoHS

SPECIFICATIONS

Electrical Rating: 0.4VA @ 20V Max (AC or DC)
Life Cycles: 50,000 Cycles
Contact Resistance: 100mΩ initial
Insulation Resistance: 500 MΩ Min. @ 500VDC
Dielectric Strength: 500VAC
Operating/Storage Temperature: -30°C to 85°C

FEATURES & BENEFITS

- Ultra-miniature in size
- Lever or rocker actuator options
- Multiple termination options
- Multiple actuator colors
- Double pole

PART NUMBER CONFIGURATOR

Series	Circuit	Function	Actuator	Actuator Color	Terminal	Contact Material	Seal
<input type="text" value="4"/> <input type="text" value="0"/> <input type="text" value="0"/> <input type="text" value="U"/>	<input type="text" value="D"/> <input type="text" value="P"/>	<input type="text" value="1"/>	<input type="text" value="R"/> <input type="text" value="1"/>	<input type="text" value="B"/> <input type="text" value="L"/> <input type="text" value="K"/>	<input type="text" value="M"/> <input type="text" value="2"/>	<input type="text" value="R"/>	<input type="text" value="E"/>
400U	DP - Double Pole	1 - ON-NONE-ON	R1 - Rocker L1 - Lever	BLK - Black RED - Red WHT - White	M2 - PC thru-hole M6 - Right Angle, PC thru-hole M7 - Vertical right angle, PC thru-hole	R - Gold	E - Epoxy

Specifications subject to change without notice



E-SWITCH®

www.e-switch.com

800.867.2717

400U SERIES ROCKER SWITCH

M2 TERMINATION

Rocker Actuator

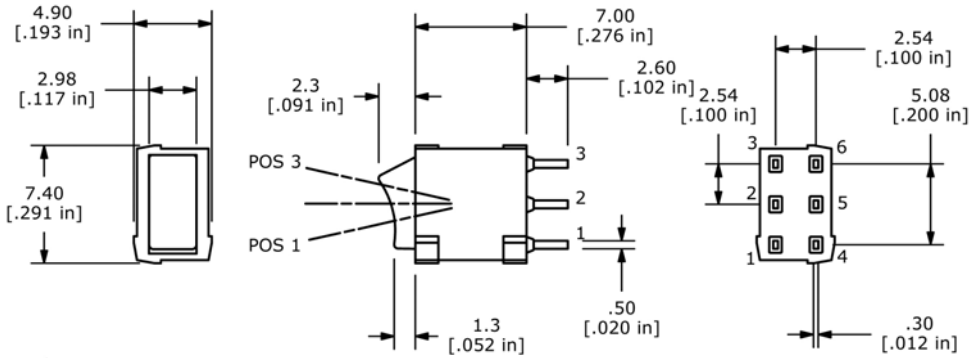

Lever Actuator

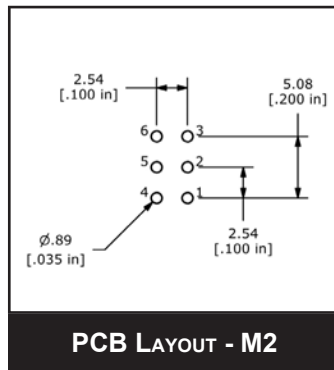
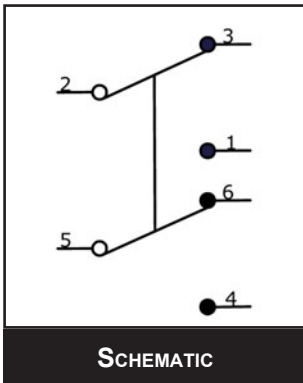
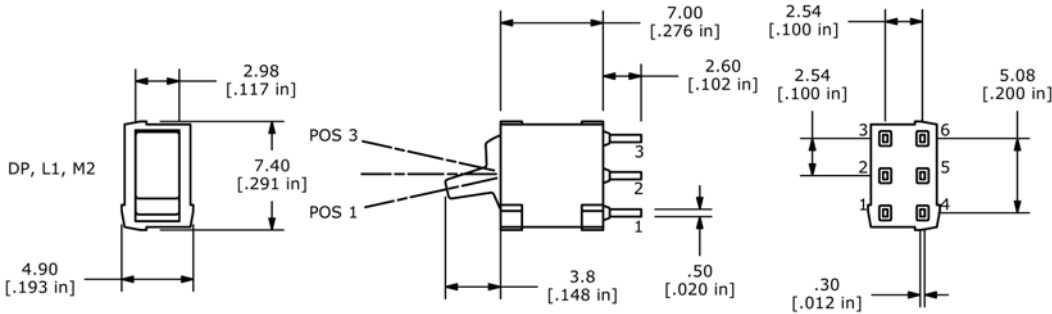

SWITCH FUNCTION		
POS. 1	POS. 2	POS. 3
ON	NONE	ON
5-6; 2-3	NONE	5-4; 2-1



400U SERIES ROCKER SWITCH

M6 TERMINATION

Rocker Actuator

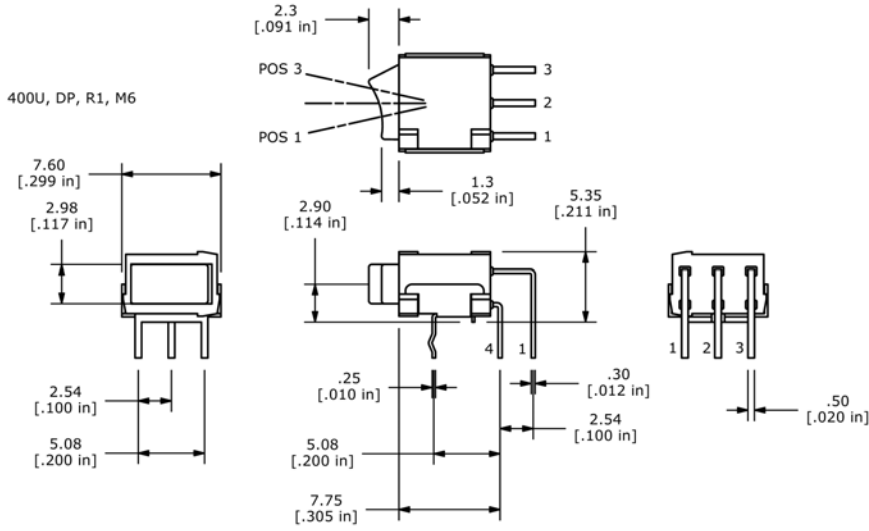

Lever Actuator

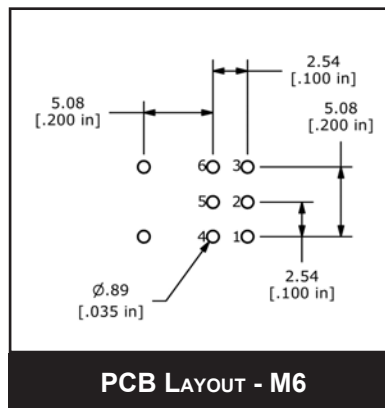
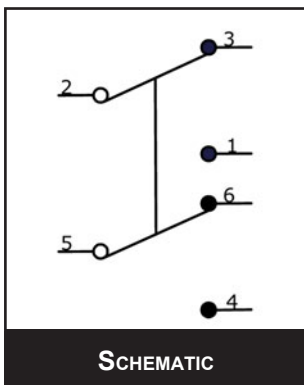
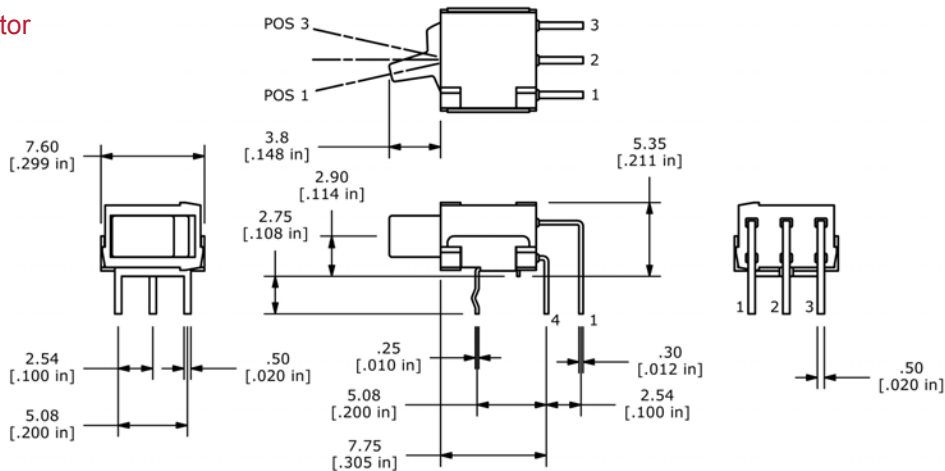

SWITCH FUNCTION		
POS. 1	POS. 2	POS. 3
ON	NONE	ON
5-6; 2-3	NONE	5-4; 2-1



400U SERIES ROCKER SWITCH

M7 TERMINATION

Rocker Actuator

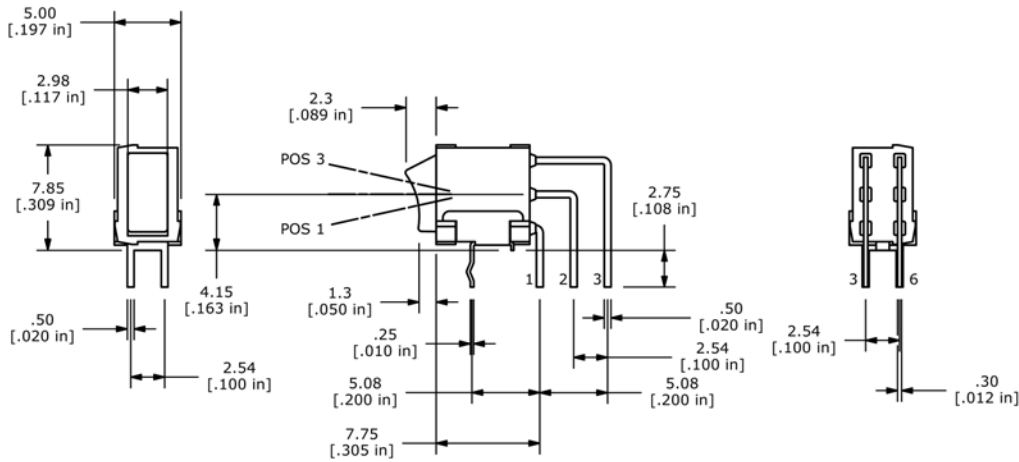

Lever Actuator

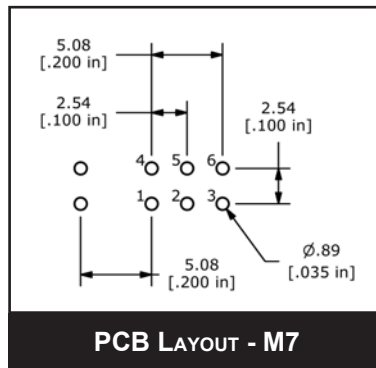
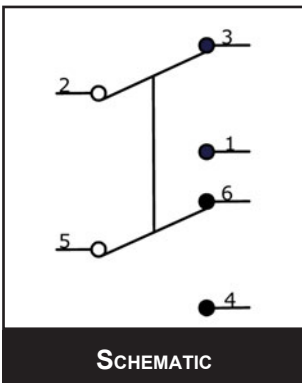
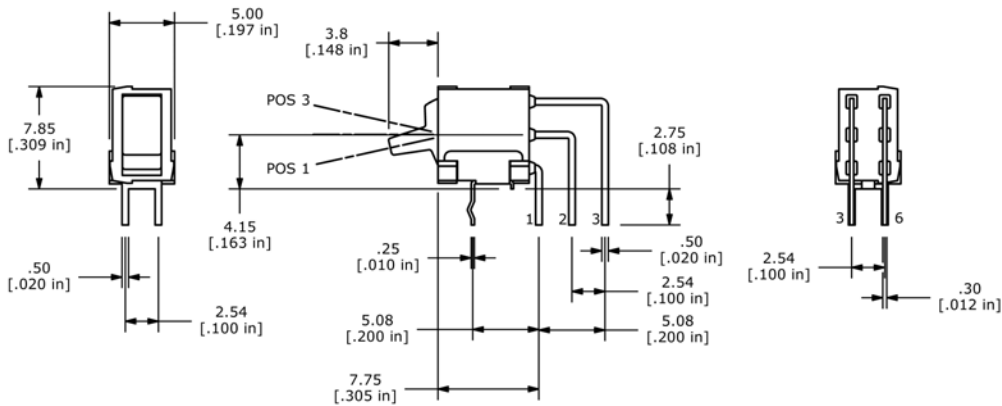

SWITCH FUNCTION		
POS. 1	POS. 2	POS. 3
ON	NONE	ON
5-6; 2-3	NONE	5-4; 2-1

