

| REVISIONS |        |   |         |        |       |
|-----------|--------|---|---------|--------|-------|
| REV       | ECO    | DESCRIPTION                                 | DATE    | BY     | APPR  |
| A1        | --     | RELEASE NEW DRAWING                         | 07APR17 | JONY   | TOMMY |
| A2        | C0870S | Change the appearance of the retaining ring | 27JUN18 | KASOON | TOMMY |
| A3        | --     | UPDATE DIMENSION                            | 03NOV21 | LYNCH  | TOMMY |

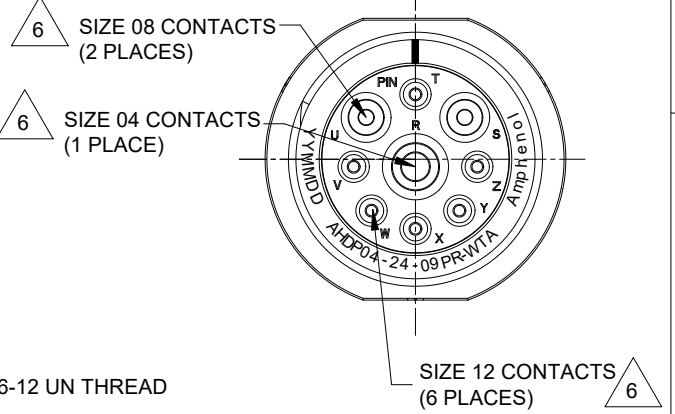

NOTES: UNLESS OTHERWISE SPECIFIED

- MATERIAL:  
HOUSING: THERMOPLASTIC; BLACK  
SEAL: SILICONE RUBBER
- MODIFICATIONS: THREADED ADAPTER;  
REDUCED DIA. WIRE SEAL
- SPECIFICATIONS:
  - OPERATING TEMPERATURE: -55°C TO +125°C.
  - DIELECTRIC WITHSTANDING VOLTAGE: LESS THAN 2 MILLIAMPS CURRENT LEAKAGE @ 1500 VOLTS AC.
  - INSULATION RESISTANCE: 1000 MEGOHM MIN @ 25°C.
  - MOISTURE RESISTANCE:  
IP68(IM OF WATER FOR A PERIOD OF 24 HOURS, MATED CONDITION);  
IP69K(MATED CONDITION)
  - MATING CYCLE DURABILITY: 100 CYCLES
  - RoHS COMPLIANT
- MATING PART: AHPD06-24-09S\* (\* = SEAL TYPE)
- ALL DIMENSIONS ARE FOR REFERENCE USE ONLY.

6 CONTACT SIZE AND WIRE RANGE:

| CONTACT SIZE | MIN. INSUL O.D.   | MAX. INSUL O.D.   | TYPICAL WIRE RANGE                  | CURRENT RATING |
|--------------|-------------------|-------------------|-------------------------------------|----------------|
| 04           | 6.63 mm (.261 in) | 7.42 mm (.292 in) | 6 AWG (16.0-13.0mm <sup>2</sup> )   | 100 AMPS       |
| 08           | 3.43 mm (.135in)  | 5.59 mm (.220 in) | 8-10 AWG (10.0-5.0mm <sup>2</sup> ) | 60 AMPS        |
| 12           | 2.46 mm (.097in)  | 4.01 mm (.158 in) | 10-14 AWG (6.0-2.0mm <sup>2</sup> ) | 25 AMPS        |

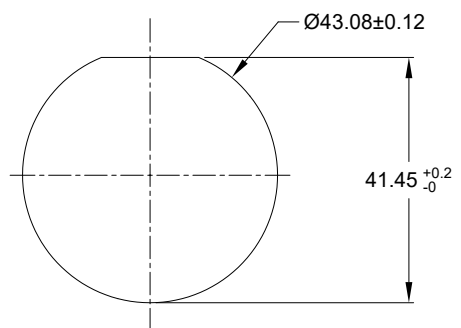

RECOMMENDED PANEL MOUNTING HOLE  
RECOMMENDED PANEL THICKNESS: 1.6 TO 4.7MM

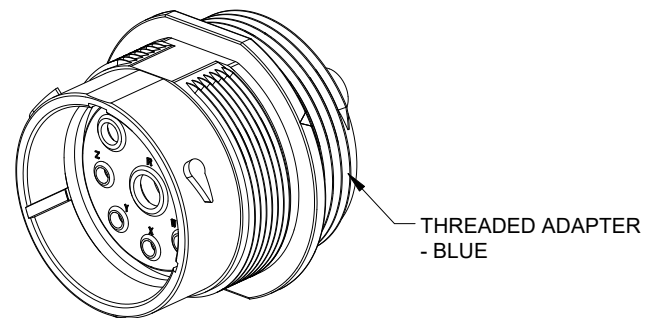

THREADED ADAPTER - BLUE

7. RECEPTACLE IS SUPPLIED WITH DUST CAP.

|                                      |             |  |             |                    |
|--------------------------------------|-------------|--|-------------|--------------------|
| AHPD04-24-09PR-WTA                   |             | DESCRIPTION  |             | ITEM               |
| QUANTITY                             | PART NUMBER | DESCRIPTION  |             |                    |
| <b>MATERIALS LIST</b>                |             |  |             |                    |
| UNLESS OTHERWISE SPECIFIED           |             | SIGNATURES   |             | DATE               |
| 1) All dimensions are in metric(mm). |             | DRAWN: LYNCH   | 03NOV21     |                    |
| 2) Tolerances are as follows:        |             | CHECKED: SULLEN  | 03NOV21     |                    |
| 1 PL DEC ±0.30                       |             | ENGINEER:  |             |                    |
| 2 PL DEC ±0.15                       |             | APPROVAL: Tommy  | 05NOV21     |                    |
| 3 PL DEC ±0.08                       |             | CUSTOMER:  |             |                    |
| 3) Note reference =                  |             |  |             |                    |
| MATERIAL SPECIFICATIONS:             |             | THIS DRAWING IS SUPPLIED FOR INFORMATION ONLY. DESIGN FEATURES, SPECIFICATIONS AND PERFORMANCE DATA SHOWN HEREON ARE THE PROPERTY OF THE AMPHENOL CORPORATION. NO RIGHTS OF REPRODUCTION ARE IMPLIED. ALL DIMENSIONS ARE SUBJECT TO NORMAL MANUFACTURING VARIATIONS. |             |                    |
| WEIGHT: 50.8G                        |             | SIZE   | TYPE        | DWG NO.            |
| PROCESS SPECIFICATIONS:              |             | B  | C-          | AHPD04-24-09PR-WTA |
| NEXT ASSY:                           |             | SCALE: NONE  | REVISION A3 |                    |



**Amphenol**  
Sine Systems - www.amphenol-sine.com  
44724 Morley Drive  
Clinton Township, MI 48036

RECEPTACLE, 24-09 POS, PIN CONTACT REDUCED DIA. SEAL, AHPD SERIES

# DuraMate™ AHDP - Contact Size 12 Options



| Machined Contacts, Sockets & Pins |  |      |       |          |
|-----------------------------------|--|------|-------|----------|
| Part Number                       | Description                            | Size | AWG   | Type     |
| AT60-204-12141-10                 | Male Contact - Pin, Nickel-plated      | 12   | 10-12 | Machined |
| AT62-203-12141-10                 | Female Contact - Socket, Nickel-plated | 12   | 10-12 | Machined |
| AT60-220-1231                     | Male Contact - Pin, Gold-plated        | 12   | 12-14 | Machined |
| AT62-210-1231                     | Female Contact - Socket, Gold-plated   | 12   | 12-14 | Machined |
| AT60-204-12141                    | Male Contact - Pin, Nickel-plated      | 12   | 12-14 | Machined |
| AT62-203-12141                    | Female Contact - Socket, Nickel-plated | 12   | 12-14 | Machined |

| DiagnosticGrade™ Machined Contacts, Sockets & Pins   |  |      |     |          |
|--|--|------|-----|----------|
| • Smaller AWG for Diagnostic Applications • Gold-plated • Increased Mating Cycles • Cost-effective |  |      |     |          |
| Part Number  | Description  | Size | AWG | Type     |
| 65-54749   | Male Contact - DiagnosticGrade™, Pin, Gold-plated      | 12   | 20  | Machined |
| AT62-210-1231-1820   | Female Contact - DiagnosticGrade™, Socket, Gold-plated | 12   | 20  | Machined |

| Tooling - Machined Contacts   |             |   |
|---|-------------|---|
| Part  | Part Number | Description   |
|  | CA-5D12     | Universal Hand Crimp Tool, Size 12/16/20 (Machined contacts only) |
|  | CA-5E12     | Pneumatic Crimp Tool, Size 12/16/20 (Machined contacts only)      |



| Contact Removal Tools   |               |  |
|---|---------------|--|
| Part  | Part Number   | Description                            |
|   | AT11-337-1205 | Contact Removal Tool, Plastic, Size 12 |
|  | A114017       | Sealing Plug, Size 12, White           |

| Stamped & Formed Contacts, Sockets & Pins |  |      |       |                  |
|---|--|------|-------|------------------|
| Part Number                               | Description                            | Size | AWG   | Type             |
| AT60-12-0244                              | Male Contact - Pin, Gold-plated        | 12   | 10-12 | Stamped & Formed |
| AT62-12-0244                              | Female Contact - Socket, Gold-plated   | 12   | 10-12 | Stamped & Formed |
| AT60-12-0222                              | Male Contact - Pin, Nickel-plated      | 12   | 10-12 | Stamped & Formed |
| AT62-12-0222                              | Female Contact - Socket, Nickel-plated | 12   | 10-12 | Stamped & Formed |
| AT60-12-0144                              | Male Contact - Pin, Gold-plated        | 12   | 12-14 | Stamped & Formed |
| AT62-12-0144                              | Female Contact - Socket, Gold-plated   | 12   | 12-14 | Stamped & Formed |
| AT60-12-0166                              | Male Contact - Pin, Nickel-plated      | 12   | 12-14 | Stamped & Formed |
| AT62-12-0166                              | Female Contact - Socket, Nickel-plated | 12   | 12-14 | Stamped & Formed |

| Tooling - Stamped & Formed Contacts   |             |   |
|---|-------------|---|
| Part  | Part Number | Description   |
|  | MFX-3973    | Crimp Die - Size 12 (S&F contacts only)                       |
|   | MFX-3985    | Crimp Die - Size 12 (S&F contacts only) 10-12AWG -02XX Series |
|  | ATT-12-00   | Hand Crimp Tool - Size 12, 12AWG (S&F contacts only)          |
|   | ATT-12-01   | Hand Crimp Tool - Size 12, 10AWG (S&F contacts only)          |



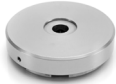

# ATHD Series™ - Contact Size 8 Options

| Machined Contacts, Pins and Sockets |  |      |      |          |      |
|-------------------------------------|--|------|------|----------|------|
| Part Number                         | Description  | Size | AWG  | Type     | Amps |
| AT60-204-08141                      | Male Contact - Pin, Copper Alloy, Nickel-Plated      | 8    | 8-10 | Machined | 60A  |
| AT62-203-08141                      | Female Contact - Socket, Copper Alloy, Nickel-Plated | 8    | 8-10 | Machined | 60A  |
| AT60-204-08141-16                   | Male Contact - Pin, Copper Alloy, Nickel-Plated      | 8    | 6    | Machined | 60A  |
| AT62-203-08141-16                   | Female Contact - Socket, Copper Alloy, Nickel-Plated | 8    | 6    | Machined | 60A  |

| Tooling - Machined Contacts   |             |  |
|---|-------------|--|
| Part  | Part Number | Description  |
|    | WA23        | Heavy Duty Pneumatic Crimp Tool<br>-Uses Universal Positioner Part No. WA23-101DA and Crimp Locator MFX-3961 |
|    | WA23-2      | Die Assembly<br>-for CA-5E12 Heavy Duty Pneumatic Crimp Tool, Size 8   |
|    | WA23-3      | Die Assembly<br>-for CA-5E12 Heavy Duty Pneumatic Crimp Tool, Size 6   |
|    | WA23-10     | Contact Locator, Size 6 and Size 8   |
|   | 96-978-22   | Crimper and Dies<br>-for Size 10mm <sup>2</sup> -185mm <sup>2</sup> Wires                                    |
|  | AT114008    | Contact Removal Tool, Plastic, Size 8, 8-10AWG   |

# ATHD Series™ - Contact Size 4 Options

| Machined Contacts, Pins and Sockets |  |      |     |          |      |
|-------------------------------------|--|------|-----|----------|------|
| Part Number                         | Description  | Size | AWG | Type     | Amps |
| AT60-203-04141-4                    | Male Contact - Pin, Copper Alloy, Nickel-Plated      | 4    | 4   | Machined | 100A |
| AT60-204-0490                       | Male Contact - Pin, Copper Alloy, Nickel-Plated      | 4    | 6   | Machined | 100A |
| AT62-203-04141-4                    | Female Contact - Socket, Copper Alloy, Nickel-Plated | 4    | 4   | Machined | 100A |
| AT62-203-04141                      | Female Contact - Socket, Copper Alloy, Nickel-Plated | 4    | 6   | Machined | 100A |

| Tooling - Machined Contacts  |               |  |
|--|---------------|--|
| Part   | Part Number   | Description  |
|   | WA23          | Heavy Duty Pneumatic Crimp Tool<br>-Uses Universal Positioner Part No. WA23-101DA and Crimp Locator MFX-3961 |
|   | WA23-138DA    | Die Assembly<br>-for Heavy Duty Pneumatic Crimp Tool, Size 4   |
|   | WA23-11       | Contact Locator, Size 4  |
|   | 96-978-22     | Crimper and Dies<br>-for Size 10mm <sup>2</sup> -185mm <sup>2</sup> Wires                                    |
|  | AT11-027-0405 | Contact Removal Tool, Plastic, Size 4, 4AWG  |